



TELEMETRY GROUP

IRIG STANDARD 106-04  
PART I

**TELEMETRY STANDARDS**

**IRIG STANDARD 106-04  
Part I**

WHITE SANDS MISSILE RANGE  
REAGAN TEST SITE  
YUMA PROVING GROUND  
DUGWAY PROVING GROUND  
ABERDEEN TEST CENTER  
NATIONAL TRAINING CENTER  
ELECTRONIC PROVING GROUND

NAVAL AIR WARFARE CENTER WEAPONS DIVISION  
NAVAL AIR WARFARE CENTER AIRCRAFT DIVISION  
NAVAL UNDERSEA WARFARE CENTER DIVISION, NEWPORT  
PACIFIC MISSILE RANGE FACILITY  
NAVAL UNDERSEA WARFARE CENTER DIVISION, KEYPORT

30TH SPACE WING  
45TH SPACE WING  
AIR FORCE FLIGHT TEST CENTER  
AIR ARMAMENT CENTER  
AIR WARFARE CENTER  
ARNOLD ENGINEERING DEVELOPMENT CENTER  
BARRY M. GOLDWATER RANGE  
UTAH TEST AND TRAINING RANGE

NATIONAL NUCLEAR SECURITY ADMINISTRATION (NEVADA)

**DISTRIBUTION A: APPROVED FOR PUBLIC RELEASE;  
DISTRIBUTION IS UNLIMITED**

This page intentionally left blank.

**TELEMETRY STANDARDS**

**MAY 2004**

**Prepared by**

**TELEMETRY GROUP  
RANGE COMMANDERS COUNCIL**

**Published by**

**Secretariat  
Range Commanders Council  
U.S. Army White Sands Missile Range,  
New Mexico 88002-5110**

**THIS DOCUMENT IS AVAILABLE ON THE  
RANGE COMMANDERS COUNCIL WEBSITE AT  
<http://jcs.mil/RCC>**

This page intentionally left blank.

## CHANGES TO THIS EDITION

Because there were so many changes to Chapter 2, *Transmitter and Receiver Systems*, Appendix-A, *Frequency Considerations for Telemetry* and Chapter 9, *Telemetry Attributes Transfer Standard (TMATS)*, the entire sections of the first two and the designated sections of the later were labeled with the “change” icon shown below.

New sections have been added and are marked with the “New” icon shown below. The new sections include the following:

- Chapter 6, Section 18, *Recorder Command and Control Mnemonics (CCM)*
- Chapter 10, *Solid State On-Board Recorder Standard*
- Appendix-M, *Properties of the Differential Encoder Specified in IRIG Standard 106 For Offset Quadrature Phase Shift Keying (OQPSK) Modulations.*

Additions and changes to this document are noted with the following icons:

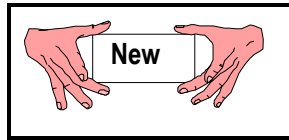
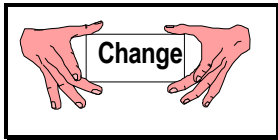

This page intentionally left blank.

## TABLE OF CONTENTS

<b>Changes to this Edition .....</b>	<b>iii</b>
<b>Table of Contents .....</b>	<b>v</b>
<b>List Of Figures .....</b>	<b>x</b>
<b>List Of Appendix Figures .....</b>	<b>xiii</b>
<b>List of Tables .....</b>	<b>xv</b>
<b>Preface .....</b>	<b>xvii</b>
<b>Acronyms and Initialisms .....</b>	<b>xix</b>
<b>CHAPTER 1 .....</b>	<b>1-1</b>
<b>Introduction .....</b>	<b>1-1</b>
<b>CHAPTER 2 .....</b>	<b>2-1</b>
<b>TRANSMITTER AND RECEIVER SYSTEMS .....</b>	<b>2-1</b>
2.1 Radio Frequency Standards for Telemetry .....	2-1
2.2 Definitions .....	2-1
2.3 UHF Bands .....	2-2
2.4 UHF Telemetry Transmitter Systems .....	2-4
2.5 UHF Telemetry Receiver Systems .....	2-16
<b>CHAPTER 3 .....</b>	<b>3-1</b>
<b>Frequency Division Multiplexing Telemetry Standards .....</b>	<b>3-1</b>
3.1 General .....	3-1
3.2 FM Subcarrier Characteristics .....	3-1
3.3 FM Subcarrier Channel Characteristics .....	3-1
3.4 Tape Speed Control and Flutter Compensation .....	3-5
<b>CHAPTER 4 .....</b>	<b>4-1</b>
<b>Pulse Code Modulation Standards .....</b>	<b>4-1</b>
4.1 General .....	4-1
4.2 Class Distinctions and Bit-Oriented Characteristics .....	4-1
4.3 Fixed Formats .....	4-2
<b>Code Waveforms .....</b>	<b>4-3</b>
4.4 Format Change (Class II) .....	4-6

4.5	Asynchronous Embedded Format (Class II) .....	4-7
4.6	Tagged Data Format (Class II) .....	4-7
4.7	Time Words .....	4-8
4.8	Asynchronous Data Merge .....	4-10
<b>CHAPTER 5.....</b>		<b>5-1</b>
<b>Digitized Audio Telemetry Standard.....</b>		<b>5-1</b>
5.1	General .....	5-1
5.2	Definitions .....	5-1
5.3	Signal Source .....	5-1
5.4	Encoding/Decoding Technique .....	5-1
5.5	CVSD Encoder Output Bit Rate (CVSD Bit Rate).....	5-2
5.6	CVSD Word Structure .....	5-2
5.7	CVSD Word Sample Rate .....	5-3
5.8	CVSD Bit Rate Determination .....	5-3
<b>CHAPTER 6.....</b>		<b>6-1</b>
<b>MAGNETIC TAPE RECORDER AND REPRODUCER STANDARDS.....</b>		<b>6-1</b>
6.1	Introduction .....	6-1
6.2	Definitions .....	6-1
6.3	General Considerations for Longitudinal Recording.....	6-6
6.4	Recorded Tape Format .....	6-7
6.5	Head and Head Segment Mechanical Parameters .....	6-16
6.6	Head Polarity .....	6-17
6.7	Magnetic Tape and Reel Characteristics .....	6-18
6.8	Direct Record and Reproduce Systems .....	6-18
6.9	Timing, Predetection, and Tape Signature Recording .....	6-20
6.10	FM Record Systems .....	6-22
6.11	PCM Recording .....	6-24
6.12	Preamble Recording for Automatic or Manual Recorder Alignment .....	6-29
6.13	19-mm Digital Cassette Helical Scan Recording Standards .....	6-29
6.14	Multiplex/Demultiplex (MUX/DEMUX) Standard for Multiple Data Channel Recording on 19-MM Digital Cassette Helical Scan Recorder/Reproducer Systems	6-32
6.15	Submultiplex/Demultiplex Standards for Multiple Data Channels on a Primary Digital Multiplex/Demultiplex Channel .....	6-35
6.16	1/2 Inch Digital Cassette (S-VHS) Helical Scan Recording Standards .....	6-40
6.17	Multiplex/Demultiplex (MUX/DEMUX) Standards for Multiple Data Channel Recording on 1/2 Inch Digital Cassette (S-VHS) Helical Scan Recorder/Reproducer Systems.....	6-56
6.18	Recorder Command and Control Mnemonics (CCM).....	6-62



<b>CHAPTER 7 .....</b>	<b>7-1</b>
<b>Magnetic Tape Standards .....</b>	<b>7-1</b>
7.1 General .....	7-1
7.2 Definitions .....	7-1
7.3 General Requirements for Standard Instrumentation Tapes and Reels .....	7-4
7.4 General Characteristics of Instrumentation Tapes and Reels .....	7-5
7.5 Physical Characteristics of Instrumentation Tapes and Reels .....	7-8
7.6 Instrumentation Tape Magnetic and Electrical Characteristics .....	7-8
7.7 General Requirements for 19-mm Digital Cassette Helical Scan Recording Tape and Cassettes .....	7-14
7.8 General Requirements for 1/2-Inch Digital Cassette Helical Scan Recording Tape and Cassettes .....	7-14
 <b>CHAPTER 8 .....</b>	 <b>8-1</b>
<b>MIL-STD-1553 Acquisition Formatting Standard .....</b>	<b>8-1</b>
8.1 General .....	8-1
8.2 Definitions .....	8-1
8.3 Source Signal .....	8-2
8.4 Word Structure .....	8-3
8.5 Time Words .....	8-5
8.6 Composite Output .....	8-5
8.7 Single Bus Track Spread Recording Format .....	8-6
 <b>CHAPTER 9 .....</b>	 <b>9-1</b>
<b>Telemetry Attributes Transfer Standard .....</b>	<b>9-1</b>
9.1 General .....	9-1
9.2 Scope .....	9-1
9.3 Purpose .....	9-1
9.4 Media and Data Structure .....	9-2
9.5 Telemetry Attributes .....	9-3
 <b>CHAPTER 10 .....</b>	 <b>10-1</b>
<b>Solid State On-Board Recorder Standard .....</b>	<b>10-1</b>
10.1 General .....	10-1
10.2 Definitions .....	10-3
10.3 Operational Requirements .....	10-5
10.4 Data Download and Electrical Interface .....	10-6
10.5 Interface File Structure Definition .....	10-8
10.6 Data Format Definition .....	10-15
10.7 Solid State Recorder Control and Status .....	10-62
10.8 Declassification .....	10-65

<b>APPENDIX A .....</b>	<b>A-1</b>
<b>Frequency Considerations for Telemetry .....</b>	<b>A-1</b>
1.0 Purpose .....	A-1
2.0 Scope .....	A-1
3.0 Authorization to Use a Telemetry System .....	A-3
4.0 Frequency Usage Guidance .....	A-4
5.0 Bandwidth.....	A-8
6.0 Spectral Occupancy Limits.....	A-15
7.0 Technical Characteristics of Digital Modulation Methods .....	A-18
8.0 FQPSK-B and FQPSK-JR Characteristics .....	A-19
9.0 SOQPSK-TG Characteristics. ....	A-22
10.0 Advanced Range Telemetry (ARTM) CPM Characteristics.....	A-23
11.0 PCM/FM.....	A-24
 <b>APPENDIX B .....</b>	 <b>B-1</b>
<b>Use Criteria for Frequency Division Multiplexing .....</b>	<b>B-1</b>
1.0 General .....	B-1
2.0 FM Subcarrier Performance .....	B-1
3.0 FM Subcarrier Performance Tradeoffs .....	B-2
4.0 FM System Component Considerations.....	B-3
5.0 Range Capability For FM Subcarrier Systems .....	B-4
 <b>APPENDIX C .....</b>	 <b>C-1</b>
<b>PCM Standards (Additional Information and Recommendations) .....</b>	<b>C-1</b>
1.0 Bit Rate Versus Receiver Intermediate-Frequency Bandwidth.....	C-1
2.0 Recommended PCM Synchronization Patterns.....	C-2
3.0 Spectral and BEP Comparisons for NRZ and Bi $\phi$ .....	C-2
4.0 PCM Frame Structure Examples .....	C-5
 <b>APPENDIX D .....</b>	 <b>D-1</b>
<b>Magnetic Tape Recorder and Reproducer.....</b>	<b>D-1</b>
<b>Information and Use Criteria .....</b>	<b>D-1</b>
1.0 Other Instrumentation Magnetic Tape Recorder Standards .....	D-1
2.0 Double-Density Longitudinal Recording .....	D-1
3.0 Serial HDDR.....	D-8
4.0 Head Parameters .....	D-15
5.0 Record Level.....	D-15
6.0 Tape Crossplay Considerations .....	D-16
7.0 Standard Tape Signature Procedures .....	D-16
8.0 Equipment Required for Swept-Frequency Procedures .....	D-19
9.0 Fixed-Frequency Plus White Noise Procedure.....	D-19

10.0	Signature Playback and Analysis.....	D-20
11.0	Recording and Playback Alignment Procedures .....	D-21
<b>APPENDIX E DELETED .....</b>		<b>E-1</b>
<b>Available Transducer Documentation .....</b>		<b>E-1</b>
<b>APPENDIX F.....</b>		<b>F-1</b>
<b>Continuously Variable Slope Delta Modulation .....</b>		<b>F-1</b>
1.0	General .....	F-1
2.0	General Descriptions .....	F-1
3.0	Detailed Descriptions .....	F-3
4.0	Reference Level .....	F-5
5.0	CVSD Characteristics .....	F-5
<b>APPENDIX G .....</b>		<b>G-1</b>
<b>ADARIO Data Block Field Definitions .....</b>		<b>G-1</b>
1.0	Data Block Format and Timing .....	G-1
2.0	ADARIO Data Format Field Definitions Summary .....	G-4
3.0	Submux Data Format Field Definitions .....	G-10
4.0	SubMux Data Format Field Definitions Summary .....	G-11
<b>APPENDIX H.....</b>		<b>H-1</b>
<b>Application of the .....</b>		<b>H-1</b>
<b>Telemetry Attributes Transfer Standard.....</b>		<b>H-1</b>
1.0	Elements of TheTelemetry Attributes Transfer Process .....	H-1
<b>APPENDIX I .....</b>		<b>I-1</b>
<b>Telemetry Attributes Transfer Standard.....</b>		<b>I-1</b>
<b>Cover Sheet .....</b>		<b>I-1</b>
1.0	Cover Sheet.....	I-1
<b>APPENDIX J.....</b>		<b>J-1</b>
<b>Telemetry Attributes Transfer Standard.....</b>		<b>J-1</b>
<b>(Format Example).....</b>		<b>J-1</b>

**APPENDIX K ..... K-1**

**Pulse Amplitude Modulation Standards ..... K-1**  
1.0 General ..... K-1  
2.0 Frame and Pulse Structure ..... K-1  
3.0 Frame and Pulse Rate ..... K-3  
4.0 Frequency Modulation ..... K-4  
5.0 Premodulation Filtering ..... K-4

**APPENDIX L ..... L-1**

**Asynchronous Recorder Multiplexer Output Re-constructor (ARMOR) ..... L-1**  
1.0 General ..... L-1

**APPENDIX M ..... 10-21**

1.0 Introduction ..... 10-21  
2.0 The Need For Differential Encoding ..... 10-21  
3.0 A Simple Solution To The Carrier Phase Ambiguity Problem ..... 10-24  
4.0 Immunity to Carrier Phase Rotation ..... 10-27  
5.0 Initial Values ..... 10-29  
6.0 Error Propagation ..... 10-30  
7.0 Recursive Processing and Code Memory ..... 10-31  
8.0 Frequency Impulse Sequence Mapping for SOQPSK ..... 10-32  
9.0 Summary ..... 10-34

**ANNEX 1 - SYSTEM LEVEL SOFTWARE REFERENCE IMPLEMENTATION OF DIFFERENTIAL ENCODER DEFINED IN IRIG STANDARD 106 FOR FQPSK AND SOQPSK MODULATIONS ..... 10-35**

1.0 Introduction ..... 10-35  
2.0 Matlab Workspace Operation ..... 10-35  
3.0 Script For Modules ..... 10-36

**INDEX**

**LIST OF FIGURES**

<u>Figure No.</u>		<u>Page No.</u>
Figure 2-1.	FQPSK-JR Baseband Signal Generator .....	2-7
Figure 2-2.	Basic SOQPSK. ....	2-9
Figure 2-3.	SOQPSK Transmitter.....	2-11
Figure 2-4.	Conceptual CPM modulator.....	2-12
Figure 2-5.	Continuous single sideband phase noise power spectral density .....	2-14
Figure 4-1.	PCM code definitions.....	4-3
Figure 4-2.	PCM frame structure.....	4-5
Figure 4-3	16 bit standardized time word format.....	4-9
Figure 4-4.	Time word insertion into 12 bit PCM word size.....	4-9

Figure 4-5.	Asynchronous word structure.....	4-11
Figure 4-6	Overhead truth table.....	4-11
Figure 5-1.	Insertion of CVSD encoded audio into a PCM stream.....	5-2
Figure 6-1.	Recorded tape format.....	6-12
Figure 6-2.	Record and reproduce head and head segment identification and location (N-track interlaced system).....	6-13
Figure 6-5.	Serial high-density digital record and reproduce.....	6-27
Figure 6-6.	Location and dimensions of recorded tracks.....	6-30
Figure 6-7.	ADARIO block format.....	6-33
Figure 6-8.	ADARIO data format.....	6-34
Figure 6-9a.	Submux data format.....	6-38
Figure 6-9b.	Submux data format.....	6-39
Figure 6-10.	Helical track dimensions, B format.....	6-41
Figure 6-11.	Helical track dimensions, E format.....	6-41
Figure 6-12.	Recorded tracks on tape, B format.....	6-45
Figure 6-13.	Tape cartridge layout.....	6-46
Figure 6-14.	Helical track format.....	6-47
Figure 6-15.	Typical VLDS data path electronics block diagram.....	6-49
Figure 6-16.	Interleave buffer architectures.....	6-51
Figure 6-17.	The steps of the build process.....	6-57
Figure 6-18.	Recorder state transition diagram.....	6-64
Figure 8-1.	System block diagram.....	8-2
Figure 8-2.	Word construction.....	8-4
Figure 8-3.	Composite frame structure.....	8-7
Figure 8-4.	Multiple tape track spread format (4-track spread example).....	8-8
Figure 9-1.	Group relationships.....	9-6
Figure 9-2.	General Information Group (G).....	9-7
Figure 9-3.	Transmission Attributes Group (T).....	9-11
Figure 9-4.	Tape/Storage Source Attributes Group (R).....	9-17
Figure 9-5.	Multiplex/Modulation Attributes Group (M).....	9-27
Figure 9-6.	PCM Format Attributes Group (P).....	9-31
Figure 9-7.	PCM Measurement Description Group (D).....	9-45
Figure 9-8.	Bus Data Attributes Group (B).....	9-57
Figure 9-9.	PAM Attributes Group (A).....	9-64
Figure 9-10.	Data Conversion Attributes Group (C).....	9-69
Figure 10-1.	Functional layout of standard.....	10-2
Figure 10-2.	Directory Block Structure.....	10-9
Figure 10-3.	Directory Block (as depicted in STANAG 4575).....	10-10
Figure 10-4.	General Packet Format.....	10-16
Figure 10-5.	A 32-Bit Packet Format Layout.....	10-17
Figure 10-6.	Packet trailer for 32-bit Data Checksum.....	10-18
Figure 10-7.	Packet trailer for 8-bit Data Checksum.....	10-18
Figure 10-8.	General PCM Data Packet, Format 1.....	10-23
Figure 10-9.	PCM Packet Channel Specific Data format.....	10-24
Figure 10-10.	PCM Data – Unpacked Mode Sample Packet.....	10-26
Figure 10-11.	PCM Data – Packed Mode Sample Packet.....	10-27

Figure 10-12. PCM Data – Throughput Mode sample packet. ....	10-28
Figure 10-13. PCM Intra-Packet header. ....	10-28
Figure 10-14. General Time Data Packet, Format 1.....	10-30
Figure 10-15. Time Data Packet Channel Specific Data Word format. ....	10-30
Figure 10-16a Time Data - Packet Format, Day Format. ....	10-32
Figure 10-16b. Time Data - Packet Format, Day, Month, And Year Format. ....	10-32
Figure 10-17. MIL-STD-1553 Packet Body Channel Specific Data Word format. ....	10-32
Figure 10-18. MIL-STD-1553 Data Packet, Format 1. ....	10-33
Figure 10-19. MIL-STD-1553 Intra-Packet Data Header. ....	10-34
Figure 10-20. Block Status Word bit definitions. ....	10-34
Figure 10-21. Gap Times Word bit definitions. ....	10-36
Figure 10-22. MIL-STD-1553 Data Packet, Format 1. ....	10-37
Figure 10-23. Generic Analog Data Packet, Format 1.....	10-38
Figure 10-24. Analog Data Packets, Channel Specific Data word format.....	10-39
Figure 10-25. Analog Data Packet – msb Unpacked Mode. ....	10-43
Figure 10-26. Analog Data Packet – lsb Unpacked Mode. ....	10-43
Figure 10-27. Analog Data Packet – Packed Mode packet. ....	10-44
Figure 10-28. General Discrete Data Packet, Format 1. ....	10-45
Figure 10-29. Discrete packet Channel Specific Data word format. ....	10-45
Figure 10-30. Discrete Data Event State word format. ....	10-46
Figure 10-31. Discrete Event Intra-Packet Data Header. ....	10-46
Figure 10-32. Discrete Data – Packet format. ....	10-47
Figure 10-33. General Computer Generated Data Packet format. ....	10-48
Figure 10-34. Computer Generated Data Packet - Channel Specific Data word format. ....	10-48
Figure 10-35. ARINC-429 Data Packet format. ....	10-49
Figure 10-36. ARINC 429 Packet Channel Specific Data Word format. ....	10-49
Figure 10-37. ARINC 429 ID Word bit definitions. ....	10-50
Figure 10-38. Message Data Packet format. ....	10-51
Figure 10-39. Complete Message Channel Specific Data Word Format. ....	10-51
Figure 10-40. Segmented type of Packet Body Channel Specific Data Word format. ....	10-52
Figure 10-41. Message Data Intra-Packet Header. ....	10-53
Figure 10-42. Intra-Packet Data Header format. ....	10-53
Figure 10-43. General MPEG-2 Video Packet, Format 0. ....	10-55
Figure 10-44. Video Packet Channel Specific Data Word format. ....	10-55
Figure 10-45. Format 0 MPEG-2 Video Frame Sync and Word format. ....	10-57
Figure 10-46. Format 0 MPEG-2 Video Data – sample packet. ....	10-57
Figure 10-47. Image Packet, Format 0. ....	10-58
Figure 10-48. Image Packet Channel Specific Data Word format. ....	10-58
Figure 10-49. Format 1 Image Data Intra-Packet Data Header. ....	10-59
Figure 10-50. UART Data Packet Format 0. ....	10-60
Figure 10-51. UART Packet Channel Specific Data Word, Format 0. ....	10-61
Figure 10-52. UART Data Intra-Packet Data Header. ....	10-61
Figure 10-53. UART Data ID Word format. ....	10-62
Figure 10-54. Required Discrete Control Functions. ....	10-63
Figure 10-55. Discrete Control and Indicator functional diagram. ....	10-65

## LIST OF APPENDIX FIGURES

<u>Figure No.</u>		<u>Page No.</u>
Figure A-1.	Spectra of 10-Mb/s CPFSK, ARTM CPM, FQPSK-JR, SOQPSK-TG signals.....	A-4
Figure A-2.	5 Mb/s PCM/FM signals with 11 MHz center frequency separation. ....	A-6
Figure A-3.	10 Mb/s ARTM CPM signals with 9 MHz center frequency separation.....	A-6
Figure A-4.	RNRZ PCM/FM signal. ....	A-10
Figure A-5.	Spectrum analyzer calibration of 0-dBc level .....	A-11
Figure A-6.	Bi $\phi$ PCM/PM signal.....	A-12
Figure A-7.	FM/AM signal and Carson's Rule .....	A-12
Figure A-8.	Typical receiver RLC IF filter response (-3 dB bandwidth = 1 MHz). ....	A-14
Figure A-9.	RLC and SAW IF filters.....	A-15
Figure A-10.	Filtered 5-Mb/s RNRZ PCM/FM signal and spectral mask.....	A-17
Figure A-11.	Unfiltered 5-Mb/s RNRZ PCM/FM signal and spectral mask. ....	A-17
Figure A-12.	Typical 5-Mb/s SOQPSK-TG signal and spectral mask.....	A-18
Figure A-13.	Typical 5-Mb/s ARTM CPM signal and spectral mask.....	A-18
Figure A-14.	OQPSK modulator.....	A-19
Figure A-15.	I & Q constellation.....	A-19
Figure A-16.	FQPSK wavelet eye diagram.....	A-20
Figure A-17.	FQPSK-B I & Q eye diagrams (at input to IQ modulator). ....	A-20
Figure A-18.	FQPSK-B vector diagram. ....	A-20
Figure A-19.	5 Mb/s FQPSK-JR spectrum with random input data and small (blue) and large (red) modulator errors. ....	A-21
Figure A-20.	FQPSK-B spectrum with all 0's input and large modulator errors. ....	A-21
Figure A-21.	FQPSK-JR BEP vs. $E_b/N_0$ . ....	A-22
Figure A-22.	Measured SOQPSK-TG phase trajectory.....	A-22
Figure A-23.	SOQPSK-TG Power Spectrum (5 Mb/s). ....	A-23
Figure A-24.	BEP versus $E_b/N_0$ performance of 5 Mb/s SOQPSK-TG. ....	A-23
Figure A-25.	Power spectrum of 5 Mb/s ARTM CPM. ....	A-23
Figure A-26.	BEP versus $E_b/N_0$ performance of 5 Mb/s ARTM CPM. ....	A-24
Figure A-27.	Power spectrum of 5 Mb/s PCM/FM signal.....	A-24
Figure A-28.	BEP versus $E_b/N_0$ performance of 5 Mb/s PCM/FM with multi-symbol bit detector and three single symbol receivers/detectors.....	A-25
Figure C-1.	BEP vs IF SNR in bandwidth = bit rate for NRZ-L PCM/FM.....	C-1
Figure C-2.	Spectral densities of random NRZ and Bi $\phi$ codes. ....	C-4
Figure C-3.	Theoretical bit error probability performance for various baseband PCM signaling techniques (perfect bit synchronization assumed).....	C-4
Figure C-4.	Major Frame Length = Minor Frame Maximum Length.....	C-6
Figure C-5.	Major Frame Length = Minor Frame Maximum Length multiplied by Z. ....	C-7
Figure C-6.	Major Frame Length = Minor Frame Maximum Length multiplied by Z. ....	C-8
Figure D-1.	Record and reproduce head and head segment identification and location (7-track interlaced system). ....	D-3
Figure D-2.	Randomizer block diagram.....	D-10
Figure D-3.	Randomized NRZ-L decoder block diagram. ....	D-12

Figure D-4.	Random PCM power spectra .....	D-13
Figure D-5a.	Biφ-L at bit packing density of 15 kb/in. ....	D-14
Figure D-5b.	RNRZ-L at bit packing density of 25 kb/in. ....	D-14
Figure D-6.	Tape crossplay. ....	D-17
Figure D-7.	Square wave responses. ....	D-22
Figure F-1a.	Typical CVSD encoder. ....	F-2
Figure F-1b.	Typical CVSD decoder. ....	F-2
Figure F-2.	Typical envelope characteristics of the decoder output signal for CVSD. ....	F-5
Figure F-3.	Interface diagram for CVSD converter. ....	F-7
Figure F-4a.	Insertion loss versus frequency for CVSD (16 kbps). ....	F-9
Figure F-4b.	Insertion loss versus frequency for CVSD (32 kbps). ....	F-9
Figure F-5a.	Variation of gain with input level for CVSD (16 kbps). ....	F-10
Figure F-5b.	Variation of gain with input level for CVSD (32 kbps). ....	F-10
Figure F-6a.	Signal to quantizing noise ratio vs input level for CVSD (16 kbps). ....	F-11
Figure F-6b.	Signal to quantizing noise ratio vs input level for CVSD (32 kbps). ....	F-11
Figure F-7a.	Signal to quantizing noise ratio versus frequency for CVSD (16 kbps). ....	F-12
Figure F-7b.	Signal to quantizing noise ratio versus frequency for CVSD (32 kbps). ....	F-12
Figure G-1.	ADARIO data format. ....	G-2
Figure G-2.	ADARIO data blocks. ....	G-3
Figure G-3.	ADARIO timing. ....	G-4
Figure G-4a.	Submux data format. ....	G-18
Figure G-4b.	Submux data format. ....	G-19
Figure G-5.	Submux aggregate format. ....	G-20
Figure H-1.	Typical elements of the telemetry attributes transfer process. ....	H-2
Figure I-1.	Sample cover sheet for attribute transfer files. ....	I-1
Figure J-1.	Group linkages. ....	J-2
Figure J-2.	PCM format for PCM w/async. ....	J-5
Figure J-3.	PCM format for PCM1. ....	J-6
Figure J-4.	PCM format for async. ....	J-7
Figure K-1.	50-percent duty cycle PAM with amplitude synchronization. ....	K-2
Figure K-2.	100-percent duty cycle PAM with amplitude synchronization. ....	K-2
Figure M-1.	Transmission System. ....	10-22
Figure M-2.	OFFSET QPSK 106 Symbol to Phase Mapping Convention. ....	10-23
Figure M-3.	Detection ambiguity. ....	10-23
Figure M-4.	QPSK State Timing. ....	10-24
Figure M-5.	OFFSET QPSK State Timing. ....	10-25
Figure M-6.	Basic SOQPSK Transmitter. ....	10-33
Figure M-7.	OQPSK Transmitter (with precoder). ....	10-33



## LIST OF TABLES

<u>Table No.</u>		<u>Page No.</u>
Table 2-1.	Telemetry Frequency Allocations.....	2-2
Table 2-2.	FQPSK-JR Shaping Filter Definition .....	2-8
Table 2-3.	FQPSK-B and FQPSK-JR Phase Map.....	2-9
Table 2-4.	SOQPSK-TG Parameters .....	2-11
Table 2-5.	SOQPSK Pre-Coding Table For IRIG-106 Compatibility.....	2-12
Table 2-6.	Dibit To Impulse Area Mapping.....	2-13
Table 3-1a.	Proportional-Bandwidth FM Subcarrier Channels ( $\pm 7.5\%$ Channels) .....	3-2
Table 3-1b.	Proportional-Bandwidth FM Subcarrier Channels ( $\pm 15\%$ Channels) .....	3-3
Table 3-1c.	Proportional-Bandwidth FM Subcarrier Channels ( $\pm 30\%$ Channels) .....	3-4
Table 3-2.	Constant-Bandwidth FM Subcarrier Channels.....	3-6
Table 3-3.	Reference Signal Usage .....	3-7
Table 6-1.	Record and Reproduce Parameters .....	6-8
Table 6-2.	Dimensions – Recorded Tape Format.....	6-9
Table 6-3.	Dimensions – Recorded Tape Format.....	6-10
Table 6-4.	Dimensions – Recorded Tape Format.....	6-11
Table 6-5.	Constant-Amplitude Speed-Control Signals .....	6-21
Table 6-6.	Predetection Carrier Parameters .....	6-22
Table 6-7.	Wide Band and Double Density Fm Record Parameters .....	6-23
Table 6-8.	Maximum Recommended Bit Rates, Post-Detection Recording .....	6-25
Table 6-9.	Maximum Recommended Bit Rates .....	6-26
Table 6-10.	Record Location and Dimensions.....	6-31
Table 6-11.	Tape Length and Nominal Play Record/Reproduce Time At 240 .....	6-31
	Megabits/Second User Data Rate .....	6-31
Table 6-12.	Scanlist Build Steps .....	6-58
Table 6-13.	Sample Armor Frame .....	6-59
Table 6-14.	Time Code Word Format .....	6-60
Table 6-15.	Command Summary .....	6-65
Table 6-16.	Command Error Codes.....	6-66
Table 6-17.	Recorder States .....	6-76
Table 6-18.	Command Validity Matrix .....	6-81
Table 6-19.	Required Commands.....	6-82
Table 7-1.	Tape Dimensions .....	7-6
Table 7-2.	Measurement Wavelengths .....	7-8
Table 7-3.	Durability Signal Losses .....	7-10
Table 7-4.	Suggested Tape Requirement Limits .....	7-12
Table 7-4a.	Suggested Wavelength Response Requirements .....	7-12
Table 9-1.	General Information Group (G).....	9-8
Table 9-2.	Transmission Attributes Group (T).....	9-12
Table 9-3.	Tape/Storage Source Attributes Group (R).....	9-19
Table 9-4.	Multiplex/Modulation Group (M) .....	9-28
Table 9-5.	PCM Format Attributes Group (P) .....	9-34
Table 9-6.	PCM Measurement Description Group (D) .....	9-47
Table 9-7.	Bus Data Attributes Group (B).....	9-59

Table 9-8.	PAM Attributes Group (A).....	9-65
Table 9-9.	Data Conversion Attributes Group (C) .....	9-71
Table 10-1.	“Required” SCSI Commands, Features, and Parameters.....	10-7
Table 10-2.	Directory Block Format – Primary Block.....	10-11
Table 10-3.	Directory Entry Format.....	10-12
Table 10-4.	Correspondence Of Bits To Bytes .....	10-14
Table 10-5.	Prohibited Characters Hexidecimal Representation .....	10-14
Table 10-6.	MP@MI Algorithms .....	10-54
Table A-1.	Coefficients For Minimum Frequency Separation Calculation.....	A-5
Table C-1.	Optimum Frame Synchronization Patterns For PCM Telemetry .....	C-3
Table D-1.	Dimensions - Recorded Tape Format_7 Tracks Interlaced On 12.7-Mm (1/2 In.) Wide Tape.....	D-4
Table D-2.	Dimensions - Recorded Tape Format .....	D-5
Table D-3.	Dimensions - Recorded Tape Format 42 Tracks Interlaced On 25.4-Mm (1-In.) Wide Tape.....	D-6
Table F-1.	Decoder Reference Digital Patterns For CVSD .....	F-7
Table F-2.	Insertion Loss Limits For CVSD.....	F-8
Table F-3.	Idle Channel Noise Limits For CVSD .....	F-11
Table L-1.	Armor Setup Preamble.....	L-1
Table L-2.	Setup Organization.....	L-2
Table L-3.	Header Section Format.....	L-3
Table L-4.	Channel Entry Lengths.....	L-4
Table L-5.	Pcm Input Channels .....	L-5
Table L-6.	Analog Input and Output Channels.....	L-6
Table L-7.	Analog Input and Output Channels.....	L-7
Table L-8.	Parallel Input Channels .....	L-8
Table L-9.	Parallel Output Channels.....	L-9
Table L-10.	Time Code Input Channels.....	L-11
Table L-11.	Time Code Output Channels .....	L-12
Table L-12.	Voice Input Channel .....	L-13
Table L-13.	Voice Output Channels .....	L-14
Table L-14.	Bit Sync Input Channels.....	L-15
Table L-15.	Trailer Section Format .....	L-16
Table M-2.	Response To Run Of 1s.....	10-27

## PREFACE

The IRIG-106 Telemetry Standards document is now published in two parts. Part I contains the more familiar information and standards that have been evolved over the years. Part II is devoted to the standards associated with the present technological evolution/ revolution in the telemetry networks area.

It is important to note that Part II is a “work in progress.” The newly formed Telemetry Networks Committee, within the Telemetry Group, is currently reviewing Part II to determine if it is appropriately structured to guide the implementation of telemetry network technology at member ranges. The findings may result in significant updates and revisions to Part II in future releases of IRIG-106.

The Telemetry Group of the Range Commanders Council has prepared this document to foster the compatibility of telemetry transmitting, receiving, and signal-processing equipment at the member ranges. The range commanders highly recommend that telemetry equipment operated by the ranges and telemetry equipment used in programs that require range support conform to these standards.

These standards do not necessarily define the existing capability of any test range, but constitute a guide for the orderly implementation of telemetry systems for both ranges and range users. The scope of capabilities attainable with the use of these standards requires a careful consideration of tradeoffs. Guidance concerning tradeoffs is provided in the text.

These standards provide the necessary criteria on which to base equipment design and modification. The ultimate purpose is to ensure efficient spectrum utilization, interference free operation, interoperability between ranges, and compatibility of range user equipment with the ranges.

This standard, published in two parts, is complemented by a companion series, RCC Document 118, *Test Methods for Telemetry Systems and Subsystems*, and RCC Document 119, *Telemetry Applications Handbook*.

The policy of the Telemetry Group is to update the telemetry standards and test methods as required being consistent with advances in the state of the art. To determine the current revision status, contact the RCC Secretariat.

Secretariat, Range Commanders Council  
CSTE-DTC-WS-RCC  
100 Headquarters Avenue  
White Sands Missile Range, New Mexico 88002-5110

TELEPHONE: (505) 678-1107  
DSN 258-1107  
EMAIL [rcc@wsmr.army.mil](mailto:rcc@wsmr.army.mil)

This page intentionally left blank.

## ACRONYMS AND INITIALISMS

ac	alternating current
ADARIO	Analog/Digital/Adaptable/Recorder Input/Output
AFC	automatic frequency control
AFTRCC	Aerospace and Flight Test Radio Coordinating Council
AFVP	ARMOR Format Verification Program
AGC	automatic gain control
ALC	automatic level control
AM	amplitude modulation
anal	analog
ANSI	American National Standards Institute
APC	automatic phase control
ARMOR	Asynchronous Real-time Multiplexer and Output Reconstructor
ARTM	Advanced Range Telemetry
AWGN	additive white Gaussian noise
BCD	binary coded decimal
BDLN	bus data link name
BEP	bit error probability
BER	bit error rate
BiØ-L	bi-phase level
BIT	built-in test
BM	block marker
BMD	block marker division
BOD	beginning of data
BOF	beginning of file
BOM	beginning of media
bps	bits per second
BRC	block rate clock
BW	bandwidth
cass	cassette
CCM	command and control mneonics
CDS	code word digital sum
CDT	channel data type
CHN	channel
CHP	channel parameter
CHT	channel type
CPFSK	continuous phase frequency shift keying
CR	carriage return
CSR	clock slip rate
CVSD	continuous variable slope delta
CW	continuous wave
CWDS	code word digital sum

DBc	C-weighted sound level
dBm	decibels referenced to 1 milliwatt
dc	direct current
DCAC	direct current or alternating current
DIBITS	digital in-band interswitch trunk signaling
DLN	data link name
DoD	Department of Defense
DPOC	dubbing organization point of contact
DS	data synchronization/sync
DSI	data source ID
DSB	double sideband
DSV	digital sum variation
DW	data words
ECC	error correction code
EDAC	error detection and correction
ENR	excess noise ratio
EOD	end of data
EOF	end of file
EOM	end of media
EIRP	effective isotropic radiated power
FC	Fibre Channel
FCC	Federal Communications Commission
FDM	frequency division multiplex
FET	field effect transistor
FFI	frame format identification/identifier
FIR	finite impulse response
FM	frequency modulation
FMG	Frequency Management Group
FQPSK	Feher's-patented quadrature phase shift keying
FS	framing and signaling
fsc	frequency of speed control
FTPMM	flux transistors per millimeter
GF	Galois field
GPS	global positioning system
G/T	gain/temperature
HDD	high density digital
HDDR	high density digital recording
HE	high energy
HR	high resolution
HW	header words

ID	identification
IF	intermediate frequency
IM	intermodulation
IMD	intermodulation distortion
IP	intercept point
ips	inches per second
IRAC	Interdepartmental Radio Advisory Committee
IRIG	Interrange Instrumentation Group
ISO	International Standards Organization
ITDE	interchannel time displacement error
ITU	International Telecommunications Union
kHz	kilohertz
ks	kiloseconds
LAOR	left subchannel over range
LBOT	logical beginning of tape
LEOT	logical end of tape
LF	line feed
LIFO	last in first out
LO	local oscillator or longitudinal
log	logarithm
LPF	low pass filter
lsb	least significant bit of a series of bits
LSB	least significant byte of a series of bytes
LSLW	least significant long word
LSW	least significant word
MAS	Military Agency for Standardization
MC	master clock
MCEB	Military Communications-Electronics Board
MCS	master clock source
MCT	manufacturer's centerline tape
MGC	manual gain control
MHz	megahertz
MIL STD	military standard
MOD	modulating
mm	millimeter
MML	magnetic media laboratory
msb	most significant bit of a series of bits
MSB	most significant byte of a series of bytes
MSCT	manufacturer's secondary centerline tape
MSK	minimum shift keying
MUX	multiplexing

N	Newton
NADSI	NATO Advanced Data Storage Interface
NATO	North Atlantic Treaty Organization
NNT	notch noise test
NPR	noise power ratio
NPRF	noise power ratio floor
NRZ	non-return-to-zero
NRZ-L	non-return-to-zero-level
NSIB	no samples in block
NTIA	National Telecommunications and Information Administration
OQPSK	offset quadrature phase shift keying
PAM	pulse-amplitude modulation
PAR/PARA	parallel
PB	principal block
PBN	principal block number
PBOT	physical beginning of tape
PCM	pulse-code modulation
PEOT	physical end of tape
PI	physical interface
PLL	phase-lock loop
PM	phase modulation
POC	point of contact
p-p	peak-to-peak
PRL	parallel
PRN	pseudo random noise
PSD	power spectral density
PSK	phase shift keying
PTF	PCM type format
PW	partial word
PWS	partial word status
Q	quality
QPSK	quadrature phase shift keying
R	bit rate
RAOR	right subchannel over range
RCC	Range Commanders Council
RF	radio frequency
RH	relative humidity
RMM	removable memory module
rms	root mean square
RNRZ	randomized non-return-to-zero
RNRZ-L	randomized non-return-to-zero-level
RO	rotary
RS	Reed-Solomon



SE	sync error
SHW	session header words
SI	Système International d'Unités
SMPTE	Society of Motion Picture and Television Engineers
SNR	signal-to-noise ratio
SOQPSK	Shaped Offset Quadrature Phase Shift Keying
SRL	serial
SSB	single sideband
SSR	solid-state recorder
SST	session start time
ST	subterminal
STANAG	standardization agreement
STO	storage
STA	subterminal address
SWR	standing wave ratio
sync	synchronization
TBE	time base error
TC	tachometer constant/tape code
TD	time delay
TK	track
TMATS	Telemetry Attributes Transfer Standard
TS	track sync
TTL	transistor-transistor logic
UBE	upper band edge
UHF	ultra high frequency
US&P	United States and Possessions
VCO	voltage controlled oscillator
VHF	very high frequency
VLDS	very large data store
WARC-92	World Administrative Radio Conference - 1992
WC	word count

This page intentionally left blank.

**CHAPTER 1**  
**INTRODUCTION**  
**PART I**

Part I of the Telemetry Standards addresses the here-to-date conventional methods, techniques, and practices affiliated with aeronautical telemetry applicable to the member RCC ranges. Part I is composed of ten chapters, with each devoted to a different element of the telemetry system or process.

Reference documents are identified at the point of reference. Commonly used terms are defined in standard reference glossaries and dictionaries. Definitions of terms with special applications are included when the term first appears, generally in the front sections of individual chapters. Radio frequency terms are defined in the *Manual of Regulations and Procedures for Federal Radio Frequency Management*. Copies of that manual may be obtained from:

Executive Secretary, Interdepartmental Radio Advisory Committee (IRAC)  
U.S. Department of Commerce, National Telecommunications and Information  
Administration (NTIA)  
Room 1605, HCHB Building  
14<sup>th</sup> and Constitution Avenue, N.W.  
Washington, D.C. 20230

This page intentionally left blank.

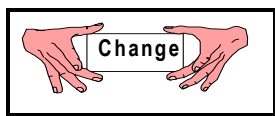

## CHAPTER 2

### TRANSMITTER AND RECEIVER SYSTEMS

#### 2.1 Radio Frequency Standards for Telemetry

These standards provide the criteria to determine equipment and frequency use requirements and are intended to ensure efficient and interference-free use of the radio frequency spectrum. These standards also provide a common framework for sharing data and providing support for test operations between ranges. The radio frequency spectrum is a limited natural resource; therefore, efficient use of available spectrum is mandatory. In addition, susceptibility to interference must be minimized. Systems not conforming to these standards require justification upon application for frequency allocation, and the use of such systems is highly discouraged. The standards contained herein are derived from the National Telecommunications and Information Administration's (NTIA) Manual of Regulations and Procedures for Federal Radio Frequency Management; see <http://www.ntia.doc.gov/osmhome/redbook/redbook.html>.

#### 2.2 Definitions

Allocation (of a Frequency Band). Entry of a frequency band into the Table of Frequency Allocations<sup>1</sup> for use by one or more radio communication services or the radio astronomy service under specified conditions.

Assignment (of a Radio Frequency (RF) or Radio Frequency Channel (RFC)). Authorization given by an administration, for a radio station to use a radio frequency or radio frequency channel under specified conditions.

Authorization. Permission to use a RF or RFC channel under specified conditions.

Occupied Bandwidth. The width of a frequency band such that below the lower and above the upper frequency limits, the mean powers emitted are each equal to a specified percentage of the total mean power of a given emission. Unless otherwise specified by the International Telecommunication Union (ITU) for the appropriate class of emission, the specified percentage shall be 0.5 percent. The occupied bandwidth is also called the 99-percent power bandwidth in this document.

Primary Service. A service that has full rights in a band of frequencies and can claim protection from harmful interference from other services.

---

<sup>1</sup> The definitions of the radio services that can be operated within certain frequency bands contained in the radio regulations as agreed to by the member nations of the International Telecommunications Union. This table is maintained in the United States by the Federal Communications Commission and the NTIA.

Secondary Service. Service that can be obtained on a noninterference operation basis with primary service users. Stations of a secondary service shall not cause harmful interference to stations of a primary service and cannot claim protection from interference from stations of a primary service; however, they can claim protection from harmful interference from other secondary stations to which frequencies were assigned at a later date.

### 2.3 UHF Bands

The bands used for telemetry are described unofficially as the lower-L band from 1435 to 1535 MHz, the lower-S band from 2200 to 2290 MHz, and the upper-S band from 2310 to 2395 MHz (see Table 2-1). The 1755 to 1850 MHz band (unofficially called “upper L-band”) can also be used for telemetry at many test ranges although it is not listed in the NTIA Table of Allocations explicitly as a telemetry band. The mobile service is a primary service in the 1755 to 1850 MHz band and telemetry is a part of the mobile service. Since the 1755-1850 MHz band is not considered a standard telemetry band per this document, potential users must coordinate, in advance, with the individual range(s) and ensure use of this band can be supported at the subject range and that it will meet their technical requirements. While these band designations are common in telemetry parlance, they may have no specific meaning to anyone else. Telemetry assignments are made for testing<sup>2</sup> manned and unmanned aircraft, for missiles, for space, land, and sea test vehicles, and for rocket sleds and systems carried on such sleds. Telemetry assignments are also made for testing major components of the systems shown above.

TABLE 2-1. TELEMETRY FREQUENCY ALLOCATIONS		
FREQUENCY RANGE (MHz)	UNOFFICIAL DESIGNATION	COMMENTS
1435-1525	Lower L-band	Telemetry primary service (part of mobile service) in USA
1525-1535	Lower L-band	Mobile satellite service (MSS) primary service, telemetry secondary service in USA
2200-2290	Lower S-band	Telemetry co-primary service in USA
2310-2360	Upper S-band	Wireless Communications Service (WCS) and broadcasting-satellite (sound) service (BSS) primary services, telemetry secondary service in USA
2360-2390	Upper S-band	Telemetry primary service in USA

<sup>2</sup>A telemetry system as defined here is not critical to the operational (tactical) function of the system.

2.3.1 Allocation of the lower-L Band (1435 to 1535 MHz). This band is allocated in the United States of America and its possessions for government and nongovernmental aeronautical telemetry use on a shared basis. The Aerospace and Flight Test Radio Coordinating Council (AFTRCC) coordinates the non-governmental use of this band. The frequencies in this range will be assigned for aeronautical telemetry and associated remote-control operations<sup>3</sup> for testing of manned or unmanned aircraft, missiles, rocket sleds, and other vehicles or their major components. Authorized usage includes telemetry associated with launching and reentry into the earth's atmosphere as well as any incidental orbiting prior to reentry of manned or unmanned vehicles undergoing flight tests. The following frequencies are shared with flight telemetering mobile stations: 1444.5, 1453.5, 1501.5, 1515.5, 1524.5, and 1525.5 MHz.

2.3.1.1 1435 to 1525 MHz. This frequency range is allocated for the exclusive use of aeronautical telemetry in the United States of America.

2.3.1.2 1525 to 1530 MHz. The 1525 to 1530 MHz band was reallocated at the 1992 World Administrative Radio Conference (WARC-92). The mobile-satellite service is now a primary service in this band. The mobile service, which includes aeronautical telemetry, is now a secondary service in this band.

2.3.1.3 1530 to 1535 MHz. The maritime mobile-satellite service is a primary service in the frequency band from 1530 to 1535 MHz<sup>4</sup>. The mobile service (including aeronautical telemetry) is a secondary service in this band.

2.3.2 Allocation of the lower-S Band (2200 to 2300 MHz). No provision is made in this band for the flight-testing of manned aircraft.

2.3.2.1 2200 to 2290 MHz. These frequencies are shared equally by the United States Government's fixed, mobile, space research, space operation, and the Earth exploration-satellite services. These frequencies include telemetry associated with launch vehicles, missiles, upper atmosphere research rockets, and space vehicles regardless of their trajectories.

2.3.2.2 2290 to 2300 MHz. Allocations in this range are for the space research service (deep space only) on a shared basis with the fixed and mobile (except aeronautical mobile) services.

2.3.3 Allocation of the Upper S Band (2310 to 2390 MHz). This band is allocated to the fixed, mobile, radiolocation, and broadcasting-satellite services in the United States of America. Government and nongovernmental telemetry users share this band in a manner similar to that of the L band. Telemetry assignments are made for flight-testing of manned or unmanned aircraft, missiles, space vehicles, or their major components.

2.3.3.1 2310 to 2360 MHz. These frequencies have been reallocated and were auctioned by the Federal Communications Commission in April 1997. The Wireless Communications Service is the primary service in the frequencies 2305-2320 MHz and 2345-2360 MHz. The broadcasting-satellite (sound) service is the primary service in the 2320-2345 MHz band. In the band

---

<sup>3</sup>The word used for remote control operations in this band is *telecommand*.

<sup>4</sup>Reallocated as of 1 January 1990.

2320-2345 MHz, the mobile and radiolocation services are allocated on a primary basis until a broadcasting-satellite (sound) service has been brought into use in such a manner as to affect or be affected by the mobile and radiolocation services in those service areas

2.3.3.2 2360 to 2390 MHz. The Mobile Service (including aeronautical telemetry) is a primary service in this band. The status of 2390-2395 MHz is in the process of being finalized. The latest version has these frequencies being made available for telemetry applications.

## 2.4 UHF Telemetry Transmitter Systems

Telemetry requirements for air, space, and ground systems are accommodated in the appropriate UHF bands 1435 to 1535, 2200 to 2300, and 2310 to 2390 MHz as described in paragraph 2.3.

2.4.1 Center Frequency Tolerance. Unless otherwise dictated by a particular application, the frequency tolerance for a telemetry transmitter shall be  $\pm 0.002$  percent of the transmitter's assigned center frequency. Transmitter designs shall control transient frequency errors associated with startup and power interruptions. During the first second after turn-on, the transmitter output frequency shall be within the occupied bandwidth of the modulated signal at any time when the transmitter output power exceeds -25 dBm. Between 1 and 5 seconds after initial turn-on, the transmitter frequency shall remain within twice the specified limits for the assigned radio frequency. After 5 seconds, the standard frequency tolerance is applicable for any and all operations where the transmitter power output is -25 dBm or greater (or produces a field strength greater than 320  $\mu\text{V}/\text{meter}$  at a distance of 30 meters from the transmitting antenna in any direction). Specific uses may dictate tolerances more stringent than those stated.

**Deleted:** <#> Channel Bandwidth Definitions. Channel bandwidths are defined below.¶  
¶  
2.4.2.1 Standard Bandwidth Signal. A standard bandwidth signal occupies a bandwidth less than or equal to 1 MHz.¶  
¶  
2.4.2.2 Wide Bandwidth Signal. A wide bandwidth signal occupies a bandwidth greater than 1 MHz.¶  
¶  
2.4.3 Channelization. Channel spacings for all types of telemetry uses are described in the following subparagraphs.¶  
¶  
2.4.3.1 Standard Bandwidth Channels. Standard bandwidth channel spacing is in increments of 1 MHz, beginning 500 kHz from the lower band edge, such as 1435.5, 1436.5, and 1437.5 MHz. By definition, the band edges of a standard bandwidth channel cannot fall outside the allocated band.¶  
2.4.3.2 Wide Bandwidth Channels. Channels with bandwidths greater than 1 MHz are assigned channels on spacings as standard bandwidth channels. The resulting spectrum is not allowed to fall outside the allocated band.¶



2.4.2 Output Power. Emitted power levels shall always be limited to the minimum required for the application. The output power shall not exceed 25 watts<sup>5</sup>. The effective isotropic radiated power (EIRP) shall not exceed 25 watts<sup>6</sup>.

Deleted: 4

2.4.3 Modulation. The traditional modulation methods for aeronautical telemetry are frequency modulation and phase modulation. Pulse code modulation (PCM)/frequency modulation (FM) has been the most popular telemetry modulation since around 1970. The PCM/FM method could also be called filtered continuous phase frequency shift keying (CPFSK). The RF signal is typically generated by filtering the baseband non-return-to-zero-level (NRZ-L) signal and then frequency modulating a voltage-controlled oscillator (VCO). The optimum peak deviation is 0.35 times the bit rate and a good choice for a premodulation filter is a multi-pole linear phase filter with bandwidth equal to 0.7 times the bit rate. Frequency and phase modulation have a variety of desirable features but may not provide the required bandwidth efficiency, especially for higher bit rates. When better bandwidth efficiency is required, the standard methods for digital signal transmission are the Feher patented quadrature phase shift keying (FQPSK-B and FQPSK-JR), the shaped offset quadrature phase shift keying (SOQPSK-TG), and the Advanced Range Telemetry (ARTM) continuous phase modulation (CPM). Each of these methods offer constant, or nearly constant, envelope characteristics and are compatible with non-linear amplifiers with minimal spectral regrowth and minimal degradation of detection efficiency. The first three methods (FQPSK-B, FQPSK-JR, and SOQPSK-TG) are interoperable and require the use of the differential encoder described in paragraph 2.4.3.1.1 below. Additional information on this differential encoder is contained in Appendix M. All of these bandwidth-efficient modulation methods require the data to be randomized. Additional characteristics of these modulation methods are discussed in the following paragraphs and in section 7 of Appendix A.

Deleted: 5

Deleted: 2.4.5

2.4.3.1 Characteristics of FQPSK-B. FQPSK-B is described in the Digcom Inc. publication, "FQPSK-B, Revision A1, Digcom-Feher Patented Technology Transfer Document, January 15, 1999." This document can be obtained under a license from:

Deleted: 5

Digcom Inc.  
44685 Country Club Drive  
El Macero, CA 95618  
Telephone: 530-753-0738  
FAX: 530-753-1788

2.4.3.1.1 Differential Encoding. Differential encoding shall be provided for FQPSK-B, FQPSK-JR, and SOQPSK-TG and shall be consistent with the following definitions:

Deleted: 2.4.5

The NRZ-L data bit sequence  $\{b_n\}$  is sampled periodically by the transmitter at time instants:

$$t = nT_b \quad n = 0, 1, 2, \dots$$

<sup>6</sup> An exemption from this EIRP limit will be considered; however, systems with EIRP levels greater than 25 watts will be considered nonstandard systems and will require additional coordination with affected test ranges.

where  $T_b$  is the NRZ-L bit period. Using the bit index values  $n$  as references to the beginning of symbol periods, the differential encoder alternately assembles I channel and Q channel symbols to form the following sequences:

$$I_2, I_4, I_6, \dots$$

and

$$Q_3, Q_5, Q_7, \dots$$

according to the following rules:

$$I_{2n} = b_{2n} \oplus \overline{Q_{(2n-1)}} \quad n > 0 \quad (2-1)$$

$$Q_{(2n+1)} = b_{(2n+1)} \oplus I_{2n} \quad n > 0 \quad (2-2)$$

where  $\oplus$  denotes the exclusive-or operator, and the bar above a variable indicates the 'not' or inversion operator. Q channel symbols are offset (delayed) relative to I channel symbols by one bit period.

**2.4.3.1.2 Characteristics Of FQPSK-JR.** FQPSK-JR is a cross-correlated, constant envelope, spectrum shaped variant of FQPSK. It assumes a quadrature modulator architecture and synchronous digital synthesis of the I and Q channel modulating signals as outlined in Figure 2-1.

Deleted: 2.4.5

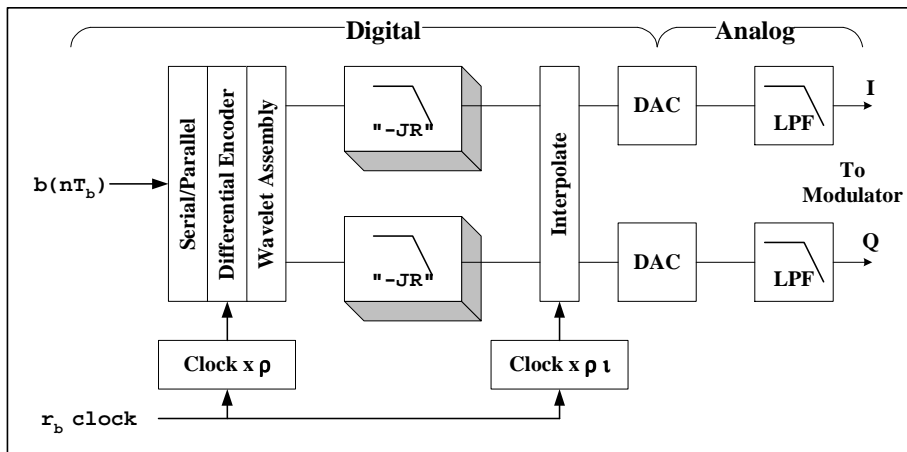

Figure 2-1. FQPSK-JR Baseband Signal Generator

FQPSK-JR utilizes the time domain wavelet functions defined in United States patent 4,567,602, with two exceptions. The transition functions,

$$G(t) = \begin{cases} \pm \left[ 1 - K \cos^2\left(\frac{\pi}{T_s}\right) \right] \\ \pm \left[ 1 - K \sin^2\left(\frac{\pi}{T_s}\right) \right] \end{cases} \quad (2-3)$$

$$K = 1 - A = 1 - \frac{\sqrt{2}}{2}$$

used in the cited patent are replaced with the following transition functions:

$$G(t) = \begin{cases} \pm \sqrt{1 - A^2 \cos^2\left(\frac{\pi t}{T_s}\right)} \\ \pm \sqrt{1 - A^2 \sin^2\left(\frac{\pi t}{T_s}\right)} \end{cases} \quad (2-4)$$

$$A = \frac{\sqrt{2}}{2}$$

where  $T_s = 2/r_b$  is the symbol period. The digital “JR” spectrum-shaping filter used for each channel is a linear phase, finite impulse response (FIR) filter. The filter is defined in terms of its impulse response sequence  $h(n)$  in Table 2-2 and assumes a fixed wavelet sample rate of  $\rho = 6$  samples per symbol. The  $JR_{equiv}$  column is the aggregate response of the cascaded  $JR_a$  and  $JR_b$  filters actually used.

TABLE 2-2. FQPSK-JR SHAPING FILTER DEFINITION			
FILTER WEIGHT	$JR_{equiv}$	$JR_a$	$JR_b$
$h(0)$	-0.046875	$2^{-2}$	$-(2^{-3} + 2^{-4})$
$h(1)$	0.109375	$h(0)$	$(2^{-1} + 2^{-3})$
$h(2)$	0.265625	$h(0)$	$h(1)$
$h(3)$	$h(2)$	-	$h(0)$
$h(4)$	$h(1)$	-	-
$h(5)$	$h(0)$	-	-

Digital interpolation is used to increase sample rate, moving all alias images created by digital to analog conversion sufficiently far away from the fundamental signal frequency range that out-of-channel noise floors can be well controlled. The FQPSK-JR reference implementations currently utilize 4-stage Cascade-Integrator-Comb (CIC) interpolators with unity memory lag factor (see reference [1]). Interpolation ratio “ $v$ ” is adjusted as a function of bit rate such that fixed cutoff frequency post-D/A anti-alias filters can be used to cover the entire range of required data rates.<sup>7</sup>

<sup>7</sup> The FQPSK-JR definition does not include a specific interpolation method and a post-D/A filter design. However, it is known that benchmark performance will be difficult to achieve if the combined effects of interpolation and anti-alias filter produce more than .04 dB excess attenuation at 0.0833 times the input sample rate and more than 1.6 dB of additional attenuation at 0.166 times the sample rate where the input sample rate is referred to the input of the interpolator assuming 6 samples per second.

2.4.3.1.3 Carrier Suppression. The remnant carrier level shall be no greater than -30 dBc. Additional information of carrier suppression can be seen at section 7 of Appendix A.

Deleted: 2.4.5

Deleted: -25

2.4.3.1.4 Quadrature Modulator Phase Map. Table 2-3 lists the mapping from the input to the modulator (after differential encoding and FQPSK-B or FQPSK-JR wavelet assembly) to the carrier phase of the modulator output. The amplitudes in Table 2-3 are  $\pm a$ , where “a” is a normalized amplitude.

Deleted: 2.4.5

TABLE 2-3. FQPSK-B AND FQPSK-JR PHASE MAP		
I CHANNEL	Q CHANNEL	RESULTANT CARRIER PHASE
a	a	45 degrees
-a	a	135 degrees
-a	-a	225 degrees
a	-a	315 degrees

2.4.3.2 Characteristics of SOQPSK-TG. SOQPSK is a family of constant envelope CPM waveforms defined by Mr. T. Hill (see references [2], [3], [4], and [5]). It is most simply described as a non-linear frequency modulation modeled as shown in Figure 2-2.

Deleted: 2.4.5

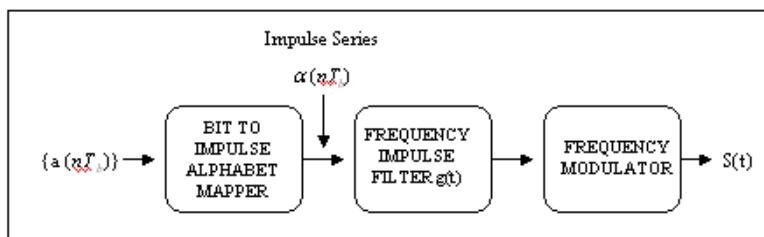

Figure 2-2. Basic SOQPSK.

The SOQPSK waveform family is uniquely defined in terms of impulse excitation of a *frequency* impulse shaping filter function  $g(t)$ :

$$g(t) = n(t)w(t) \quad (2-5)$$

where

$$n(t) \equiv \left[ \frac{A \cos \pi \theta_1(t)}{1 - 4\theta_1^2(t)} \right] \left[ \frac{\sin \theta_2(t)}{\theta_2(t)} \right] \quad (2-6)$$

$$\theta_1(t) = \frac{\rho B t}{T_s}$$

$$\theta_2(t) = \frac{\pi B t}{T_s}$$

$$w(t) \equiv \begin{cases} 1, & \left| \frac{t}{T_s} \right| \leq T_1 \\ \frac{1}{2} \left[ 1 + \cos \left( \frac{\pi \left( \left| \frac{t}{T_s} \right| - T_1 \right)}{T_2} \right) \right], & T_1 < \left| \frac{t}{T_s} \right| \leq T_1 + T_2 \\ 0, & \left| \frac{t}{T_s} \right| > T_1 + T_2 \end{cases} \quad (2-7)$$

$n(t)$  is a modified spectral raised cosine filter of amplitude  $A$ , rolloff factor  $\rho$  and having an additional time scaling factor  $B$ . The function  $w(t)$  is a time domain windowing function that limits the duration of  $g(t)$ . The amplitude scale factor  $A$  is chosen such that

$$\int_{-(T_1+T_2)T_s}^{(T_1+T_2)T_s} g(t) dt = \frac{\pi}{2} \quad (2-8)$$

Given a time series binary data sequence

$$\vec{a} = (\dots, a_{-2}, a_{-1}, a_0, a_1, a_2, \dots) \quad (2-9)$$

wherein the bits are represented by normalized antipodal amplitudes  $\{+1, -1\}$ , the ternary impulse series is formed with the following mapping rule. See also references [4] and [5].

$$\alpha = (-1)^{i+1} \frac{a_{i-1}(a_i - a_{i-2})}{2} \quad (2-10)$$

... which forms a data sequence alphabet of three values  $\{+1,0,-1\}$ . It is important to note that this modulation definition does not establish an absolute relationship between the digital in-band inter-switch trunk signaling (dibits) of the binary data alphabet and transmitted phase as with conventional quadriphase OQPSK implementations. In order to achieve interoperability with coherent FQPSK-B demodulators, some form of precoding must be applied to the data stream prior to, or in conjunction with, conversion to the ternary excitation alphabet. The differential encoder defined in paragraph 2.4.3.1.1 fulfills this need. However, to guarantee full interoperability with the other waveform options, the polarity relationship between frequency impulses and resulting frequency or phase change must be controlled. Thus, SOQPSK modulators proposed for this application shall guarantee that an impulse of value of (+1) will result in an advancement of the transmitted phase relative to that of the nominal carrier frequency (i.e., the instantaneous frequency is above the nominal carrier).

Deleted: 2.4.5

For purposes of this standard, only one specific variant of SOQPSK and SOQPSK-TG is acceptable. This variant is defined by the parameter values given in Table 2-4.

TABLE 2-4. SOQPSK-TG PARAMETERS				
SOQPSK TYPE	$\rho$	B	$T_1$	$T_2$
SOQPSK-TG	0.70	1.25	1.5	0.50

2.4.3.2.1 Differential Encoding of SOQPSK-TG. As discussed above, interoperability with FQPSK-B equipment requires a particular pre-coding protocol or a functional equivalent thereof. A representative model is shown in Figure 2-3.

Deleted: 2.4.5

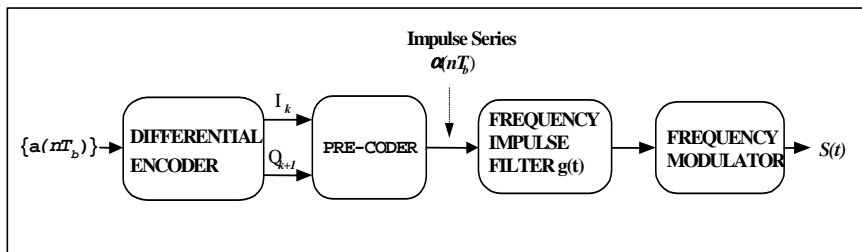

Figure 2-3. SOQPSK Transmitter.

The differential encoder block will be implemented in accordance with the definition of Section 2.4.3.1.1. Given the symbol sequences  $I_k$  and  $Q_k$ , and the proviso that a normalized impulse sign of +1 will increase frequency, the pre-coder will provide interoperability with the FQPSK signals defined herein if code symbols are mapped to frequency impulses in accordance with Table 2-5 (below) where  $\Delta\Phi$  is the phase change.

Deleted: 2.4.5

TABLE 2-5. SQPSK PRE-CODING TABLE FOR IRIG-106 COMPATIBILITY									
MAP $\alpha_k$ FROM $I_k$					MAP $\alpha_{k+1}$ FROM $Q_{k+1}$				
$I_k$	$Q_{k-1}$	$I_{k-2}$	$\Delta\Phi$	$\alpha_k$	$Q_{k+1}$	$I_k$	$Q_{k-1}$	$\Delta\Phi$	$\alpha_{k+1}$
-1	X*	-1	0	0	-1	X*	-1	0	0
+1	X*	+1	0	0	+1	X*	+1	0	0
-1	-1	+1	$-\pi/2$	-1	-1	-1	+1	$+\pi/2$	+1
-1	+1	+1	$+\pi/2$	+1	-1	+1	+1	$-\pi/2$	-1
+1	-1	-1	$+\pi/2$	+1	+1	-1	-1	$-\pi/2$	-1
+1	+1	-1	$-\pi/2$	-1	+1	+1	-1	$+\pi/2$	+1

\* Note: Does not matter if "X" is a +1 or a -1

2.4.3.3 Characteristics of Advanced Range Telemetry (ARTM) CPM. ARTM CPM is a quaternary signaling scheme in which the instantaneous frequency of the modulated signal is a function of the source data stream. The frequency pulses are shaped for spectral containment purposes. The modulation index alternates at the symbol rate between two values to improve the likelihood that the transmitted data is faithfully recovered. Although the following description is in terms of carrier frequency, other representations and generation methods exist that are equivalent. A block diagram of a conceptual ARTM CPM modulator is illustrated in Figure 2-4. Source bits are presented to the modulator and are mapped into impulses that are applied to a filter with an impulse response  $g(t)$ . The resulting waveform  $f(t)$  is proportional to the instantaneous frequency of the desired modulator output. This signal can be used to frequency modulate a carrier to produce an RF signal representation.

Deleted: 2.4.5

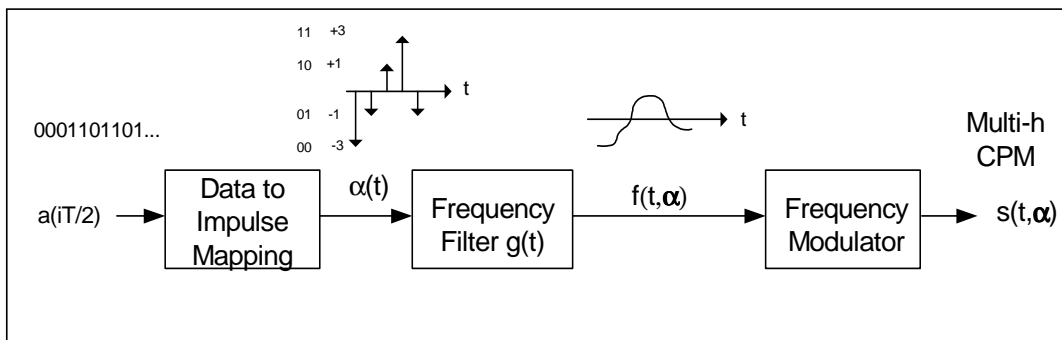

Figure 2-4. Conceptual CPM modulator.



Variables and function definitions in Figure 2-4 above are as follows:

- $a(iT/2)$  =  $i$ th bit of binary source data, either a 0 or 1
- The frequency pulse shape for ARTM CPM is a three symbol long raised cosine pulse defined by  $g(t) = \frac{1}{6T} \left[ 1 - \cos\left(\frac{2\pi t}{3T}\right) \right]$  for  $0 \leq t \leq 3T$  (2-11)
- $T$  = Symbol period equal to  $2/(\text{bit rate in bits/second})$
- $\alpha(iT)$  =  $i$ th impulse with area equal to either a +3,+1,-1 or -3 determined by Table 2-6 below. Note that an impulse is generated for each dibit pair (at the symbol rate).
- $f(t,\alpha)$  = frequency filter output equal to  $\pi h_i \sum_{i=-\infty}^{+\infty} \alpha(iT) g(t - iT)$  (2-12)
- $h$  = modulation index;  $h$  alternates between  $h_1$  and  $h_2$  where  $h_1 = 4/16$ ,  $h_2 = 5/16$

TABLE 2-6. DIBIT TO IMPULSE AREA MAPPING	
INPUT DIBIT [a(i) a(i+1)]	IMPULSE AREA
1 1	+3
1 0	+1
0 1	-1
0 0	-3

For more information on the ARTM CPM waveform, please refer to Appendix A of this document and to the publication at reference [6].

2.4.3.4 Data Randomization. The data input to the transmitter shall be randomized using either an encryptor that provides randomization or an Interrange Instrumentation Group (IRIG) 15-bit randomizer as described in Chapter 6 and Appendix D. The purpose of the randomizer is to prevent degenerative data patterns from degrading data quality.

Deleted: 2.4.5

2.4.3.5 Bit Rate. The bit rate range for FQPSK-B, FQPSK-JR, and SQPSK-TG shall be between 1 Mb/s and 20 Mb/s. The bit rate range for ARTM CPM shall be between 5 Mb/s and 20 Mb/s.

Deleted: 2.4.5

2.4.3.6 Transmitter Phase Noise. The sum of all discrete spurious spectral components (single sideband) shall be less than -36 dBc. The continuous single sideband phase noise power spectral density (PSD) shall be below the curve shown in Figure 2-5 below. The maximum frequency for the curve in Figure 2-5 is one-fourth of the bit rate. For bit rates greater than 4 Mb/s, the phase noise PSD shall be less than -100 dBc/Hz between 1 MHz and one-fourth of the bit rate.

Deleted: 2.4.5

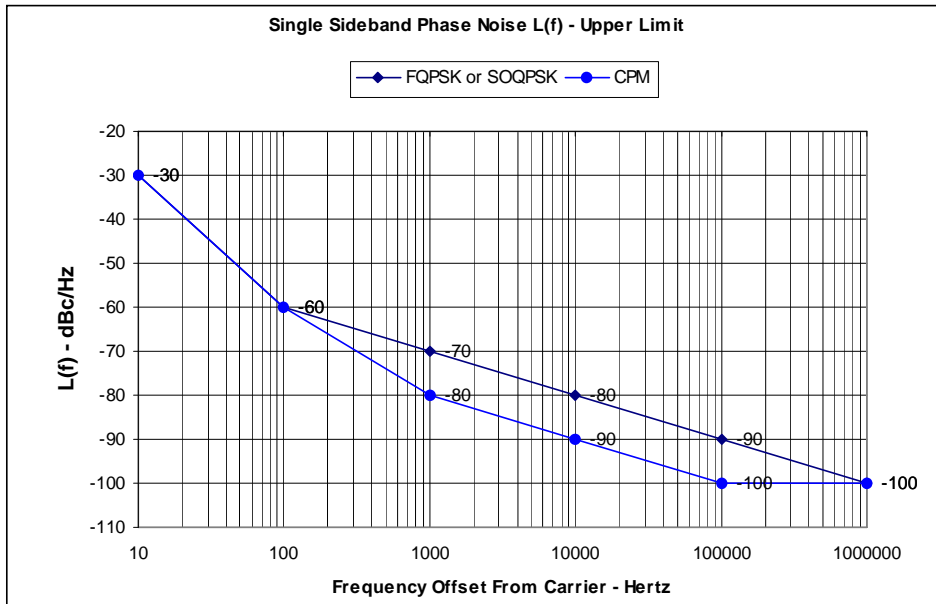

Figure 2-5. Continuous single sideband phase noise power spectral density

2.4.3.7 Modulation Polarity. An increasing voltage at the input of a frequency modulation (FM) transmitter shall cause an increase in output carrier frequency. An increase in voltage at the input of a phase modulation (PM) transmitter shall cause an advancement in the phase of the output carrier. An increase in voltage at the input of an amplitude modulation (AM) transmitter shall cause an increase in the output voltage of the output carrier.

Deleted: 2.4.5

2.4.4 Spurious Emission and Interference Limits. Spurious<sup>8</sup> emissions from the transmitter case, through input and power leads, and at the transmitter radio frequency (RF) output and antenna-radiated spurious emissions are to be within required limits shown in MIL-STD-461, Electromagnetic Emission and Susceptibility Requirements for the Control of Electromagnetic Interference. Other applicable standards and specifications may be used in place of MIL-STD-461 if necessary.

Deleted: 6

2.4.4.1 Transmitter-Antenna System Emissions. Emissions from the antenna are of primary importance. For example, a tuned antenna may or may not attenuate spurious frequency products produced by the transmitter, and an antenna or multi-transmitter system may generate spurious outputs when a pure signal is fed to its input. The transmitting pattern of such spurious frequencies is generally different from the pattern at the desired frequency. Spurious outputs in the transmitter output line shall be limited to -25 dBm. Antenna-radiated spurious outputs shall be no greater than 320  $\mu$ V/meter at 30 meters in any direction.

Deleted: 6

<sup>8</sup> Any unwanted signal or emission is spurious whether or not it is related to the transmitter frequency (harmonic).

**WARNING:** Spurious levels of -25 dBm may severely degrade performance of sensitive receivers whose antennas are located in close proximity to the telemetry transmitting antenna. Therefore, lower spurious levels may be required in certain frequency ranges, such as near GPS frequencies.

2.4.4.2

Deleted: 6

**Conducted and Radiated Interference.** Interference (and the RF output itself) radiated from the transmitter or fed back into the transmitter power, signal, or control leads could interfere with the normal operation of the transmitter or the antenna system to which the transmitter is connected. All signals conducted by the transmitter's leads (other than the RF output cable) in the range of 150 kHz to 50 MHz, and all radiated fields in the range of 150 kHz to 10 GHz (or other frequency ranges as specified) must be within the limits of the applicable standards or specifications.

2.4.5 **Operational Flexibility.** Each transmitter shall be capable of operating at all frequencies within its allocated band without design modification<sup>9</sup>.

Deleted: 7

2.4.6 **Modulated Transmitter Bandwidth.**<sup>10</sup> Telemetry applications covered by this standard shall use 99-percent power bandwidth to define occupied bandwidth and -25 dBm bandwidth as the primary measure of spectral efficiency. The -25 dBm bandwidth is the minimum bandwidth that contains all spectral components that are -25 dBm or larger. A power level of -25 dBm is exactly equivalent to an attenuation of the transmitter power by  $55 + 10 \times \log(P)$  dB where P is the transmitter power expressed in watts. The spectra are assumed symmetrical about the transmitter's center frequency unless specified otherwise. All spectral components larger than  $-(55 + 10 \times \log(P))$  dBc at the transmitter output must be within the spectral mask calculated using the following equation:

Deleted: 8

$$M(f) = K + 90 \log R - 100 \log |f - f_c|; |f - f_c| \geq \frac{R}{m} \quad (2-13)$$

<sup>9</sup> The intent is that fixed frequency transmitters can be used at different frequencies by changing crystals or other components. All applicable performance requirements will be met after component change.

<sup>10</sup> These bandwidths are measured using a spectrum analyzer with the following settings: 30-kHz resolution bandwidth, 300-Hz video bandwidth, and no max hold detector or averaging.

where

- $M(f)$  = power relative to P (i.e., units of dBc) at frequency  $f$  (MHz)
- K = -20 for analog signals
- K = -28 for binary signals
- K = -61 for FQPSK-B, FQPSK-JR, SOQPSK-TG
- K = -73 for ARTM CPM
- $f_c$  = transmitter center frequency (MHz)
- R = bit rate (Mb/s) for digital signals or  
( $\Delta f + f_{\max}$ ) (MHz) for analog FM signals
- m = number of states in modulating signal;  
m = 2 for binary signals  
m = 4 for quaternary signals and analog signals
- $\Delta f$  = peak deviation
- $f_{\max}$  = maximum modulation frequency

Note that the mask in this standard is different than the masks contained in earlier versions of the Telemetry Standards. Equation (2-13) does not apply to spectral components separated from the center frequency by less than  $R/m$ . The -25 dBm bandwidth is not required to be narrower than 1 MHz. Binary signals include all modulation signals with two states while quaternary signals include all modulation signals with four states (quadrature phase shift keying and FQPSK-B are two examples of four-state signals). Appendix A, paragraph 6.0, contains additional discussion and examples of this spectral mask.

## 2.5 UHF Telemetry Receiver Systems

As a minimum, UHF receiver systems shall have the following characteristics:

2.5.1 Spurious Emissions. The RF energy radiated from the receiver itself or fed back into the power supply, and/or the RF input, output, and control leads in the range from 150 kHz to 10 GHz shall be within the limits specified in MIL-STD 461. The receiver shall be tested in accordance with MIL-STD 461 or RCC Document 118, volume II, Test Methods for Telemetry RF Subsystems. Other applicable standards and specifications may be used in place of MIL-STD-461, if necessary.

2.5.2 Frequency Tolerance. The accuracy of all local oscillators within the receiver shall be such that the conversion accuracy at each stage and overall is within  $\pm 0.001$  percent of the indicated tuned frequency under all operating conditions for which the receiver is specified.

2.5.3 Receiver Phase Noise. The sum of all discrete spurious spectral components (single sideband) shall be less than -39 dBc. The continuous single sideband phase noise power spectral density (PSD) shall be 3 dB below the curve shown in Figure 2-5. The maximum frequency for the curve in Figure 2-5 is one-fourth of the bit rate. For bit rates greater than 4 Mb/s, the phase noise PSD shall be less than -103 dBc/Hz between 1 MHz and one-fourth of the bit rate.

2.5.4 Spurious Responses. Rejection of any frequency other than the one to which the receiver is tuned shall be a minimum of 60 dB referenced to the desired signal over the range 150 kHz to 10 GHz.

2.5.5 Operational Flexibility. All ground-based receivers shall be capable of operating over the entire band for which they are designed. External down-converters may be either intended for the entire band or a small portion but capable of retuning anywhere in the band without modification.

2.5.6 Intermediate Frequency (IF) Bandwidths. The standard receiver IF bandwidths are shown in Table 2-7. These bandwidths are separate from and should not be confused with post-detection low-pass filtering that receivers provide.<sup>11</sup> The ratio of the receiver's -60 dB bandwidth to the -3 dB bandwidth shall be less than 3 for new receiver designs.

TABLE 2-7. STANDARD RECEIVER INTERMEDIATE FREQUENCY (IF) BANDWIDTHS		
300 kHz	1.5 MHz	6 MHz
500 kHz	2.4 MHz	10 MHz
750 kHz	3.3 MHz	15 MHz
1000 kHz	4.0 MHz	20 MHz



1. For data receivers, the IF bandwidth should typically be selected so that 90 to 99 percent of the transmitted spectrum is within the receiver 3-dB bandwidth. In most cases, the optimum IF bandwidth will be narrower than the 99-percent power bandwidth.
2. Bandwidths are expressed at the points where response is 3 dB below the response at the design center frequency, assuming that passband ripple is minimal, which may not be the case. The 3-dB bandwidth is chosen because it closely matches the noise bandwidth of a "brick-wall" filter of the same bandwidth. The "optimum" bandwidth for a specific application may be other than that stated here. Ideal IF filter response is symmetrical about its center frequency; in practice, this may not be the case.
3. Not all bandwidths are available on all receivers or at all test ranges. Additional receiver bandwidths may be available at some test ranges [especially if the range has receivers with digital IF filtering](#)

<sup>11</sup> In most instances, the output low-pass filter should *not* be used to "clean up" the receiver output prior to use with demultiplexing equipment.

## References: Chapter 2

**Deleted:** ‡ see note below¶  
‡ see note bel

- [1] Hogenauer, E., “An Economical Class of Digital Filters for Decimation and Interpolation, IEEE Transactions on Acoustics, Speech, and Signal Processing”, Vol. ASSP-29, No. 2, April 1981.
- [2] Hill T., “An Enhanced, Constant Envelope, Interoperable Shaped Offset QPSK(SOQPSK) Waveform for Improved Spectral Efficiency”, Proceedings of the International Telemetry Conference, San Diego, California, October 2000.
- [3] Younes B., Brase J., Patel C., Wesdock J., “An Assessment of Shaped Offset QPSK for Use in NASA Space Network and Ground Network Systems”, Meetings of Consultative Committee for Space Data Systems, Toulouse, France, October, 2000.
- [4] Geoghegan, M., “Implementation and Performance Results for Trellis Detection of SOQPSK”, Proceedings of the International Telemetry Conference, Las Vegas, Nevada, October 2001.
- [5] Simon, M., “Bandwidth-Efficient Digital Modulation with Application to Deep Space Communications”, Monograph number 3, DESCANSO Monograph Series, JPL Publication 00-17, Jet Propulsion Laboratory, California Institute of Technology, 2001. This publication is available free via the Internet at [DESCANSO: Deep Space Communications and Navigation Systems](#)
- [6] Geoghegan, M. “Description and Performance Results for the multi-h CPM Tier II Waveform”, Proceedings of the International Telemetry Conference, San Diego, CA, October 2000.

**Deleted:** 3. (†) Bandwidths are for use with standard bandwidth channels.¶  
¶  
4. (‡) Bandwidths are for use with wide bandwidth channels.¶

This page intentionally left blank.

## CHAPTER 3

### FREQUENCY DIVISION MULTIPLEXING TELEMETRY STANDARDS

#### 3.1 General

In frequency division multiplexing, each data channel makes use of a separate subcarrier that occupies a defined position and bandwidth in the modulation baseband of the RF carrier. Two types of frequency modulation (FM) subcarrier formats may be used. The data bandwidth of one format type is proportional to the subcarrier center frequency, while the data bandwidth of the other type is constant, regardless of subcarrier frequency.

#### 3.2 FM Subcarrier Characteristics

In these systems, one or more subcarrier signals, each at a different frequency, are employed to frequency modulate (FM) or phase modulate (PM) a transmitter in accordance with the RF conditions specified in Chapter 2. The following subparagraphs set forth the standards for utilization of FM frequency division multiplexing.

3.2.1 Each of the subcarriers conveys measurement data in FM form. The number of data channels may be increased by modulating one or more of the subcarriers with a time-division multiplex format such as pulse-code modulation (PCM).

3.2.2 The selecting and grouping of subcarrier channels depend upon the data bandwidth requirements of the application at hand and upon the necessity to ensure adequate guard bands between channels. Combinations of both proportional-bandwidth channels and constant-bandwidth channels may be used.

#### 3.3 FM Subcarrier Channel Characteristics

The following subparagraphs describe the characteristics of proportional-bandwidth and constant-bandwidth FM subcarrier channels.

3.3.1 Proportional-Bandwidth FM Subcarrier Channel Characteristics. Tables 3-1 (A-C) list the standard proportional-bandwidth FM subcarrier channels. The channels identified with letters permit  $\pm 15$  or  $\pm 30$  percent subcarrier deviation rather than  $\pm 7.5$  percent deviation but use the same frequencies as the 12 highest channels. The channels shall be used within the limits of maximum subcarrier deviation. See Appendix B for expected performance tradeoffs at selected combinations of deviation and modulating frequency.



**TABLE 3-1A. PROPORTIONAL-BANDWIDTH FM SUBCARRIER CHANNELS  
±7.5% CHANNELS**

<b>Channel</b>	<b>Center Frequencies (Hz)</b>	<b>Lower Deviation Limit (Hz)</b>	<b>Upper Deviation Limit (Hz)</b>	<b>Nominal Frequency Response (Hz)</b>	<b>Nominal Rise Time (ms)</b>	<b>Maximum Frequency Response (Hz)</b>	<b>Minimum Rise Time (ms)</b>
1	400	370	430	6	58	30	11.7
2	560	518	602	8	44	42	8.33
3	730	675	785	11	32	55	6.40
4	960	888	1032	14	25	72	4.86
5	1300	1202	1398	20	18	98	3.60
6	1700	1572	1828	25	14	128	2.74
7	2300	2127	2473	35	10	173	2.03
8	3000	2775	3225	45	7.8	225	1.56
9	3900	3607	4193	59	6.0	293	1.20
10	5400	4995	5805	81	4.3	405	.864
11	7350	6799	7901	110	3.2	551	.635
12	10 500	9712	11 288	160	2.2	788	.444
13	14 500	13 412	15 588	220	1.6	1088	.322
14	22 000	20 350	23 650	330	1.1	1650	.212
15	30 000	27 750	32 250	450	.78	2250	.156
16	40 000	37 000	43 000	600	.58	3000	.117
17	52 500	48 562	56 438	788	.44	3938	.089
18	70 000	64 750	75 250	1050	.33	5250	.06
19	93 000	86 025	99 975	1395	.25	6975	.050
20	124 000	114 700	133 300	1860	.19	9300	.038
21	165 000	152 625	177 375	2475	.14	12 375	.029
22	225 000	208 125	241 875	3375	.10	16 875	.021
23	300 000	277 500	322 500	4500	.08	22 500	.016
24	400 000	370 000	430 000	6000	.06	30 000	.012
25	560 000	518 000	602 000	8400	.04	42 000	.008

See notes at end of Table 3-1C.

**TABLE 3-1B. PROPORTIONAL-BANDWIDTH FM SUBCARRIER CHANNELS  
±15% CHANNELS**

<b>Channel</b>	<b>Center Frequencies (Hz)</b>	<b>Lower Deviation Limit (Hz)</b>	<b>Upper Deviation Limit (Hz)</b>	<b>Nominal Frequency Response (Hz)</b>	<b>Nominal Rise Time (ms)</b>	<b>Maximum Frequency Response (Hz)</b>	<b>Minimum Rise Time (ms)</b>
A	22 000	18 700	25 300	660	.53	3300	.106
B	30 000	25 500	34 500	900	.39	4500	.078
C	40 000	34 000	46 000	1200	.29	6000	.058
D	52 500	44 625	60 375	1575	.22	7875	.044
E	70 000	59 500	80 500	2100	.17	10 500	.033
F	93 000	79 050	106 950	2790	.13	13 950	.025
G	124 000	105 400	142 600	3720	.09	18 600	.018
H	165 000	140 250	189 750	4950	.07	24 750	.014
I	225 000	191 250	258 750	6750	.05	33 750	.010
J	300 000	255 000	345 000	9000	.04	45 000	.008
K	400 000	340 000	460 000	12 000	.03	60 000	.006
L	560 000	476 000	644 000	16 800	.02	84 000	.004

See notes at end of Table 3-1C.

**TABLE 3-1C. PROPORTIONAL-BANDWIDTH FM SUBCARRIER CHANNELS  
±30% CHANNELS**

<b>Channel</b>	<b>Center Frequencies (Hz)</b>	<b>Lower Deviation Limit (Hz)</b>	<b>Upper Deviation Limit (Hz)</b>	<b>Nominal Frequency Response (Hz)</b>	<b>Nominal Rise Time (ms)</b>	<b>Maximum Frequency Response (Hz)</b>	<b>Minimum Rise Time (ms)</b>
AA	22 00	15 400	28 600	1320	.265	6600	.053
BB	30 000	21 000	39 000	1800	.194	9000	.038
CC	40 000	28 000	52 000	2400	.146	12 000	.029
DD	52 500	36 750	68 250	3150	.111	15 750	.022
EE	70 000	49 000	91 000	4200	.083	21 000	.016
FF	93 000	65 100	120 900	5580	.063	27 900	.012
GG	124 000	86 800	161 200	7440	.047	37 200	.009
HH	165 000	115 500	214 500	9900	.035	49 500	.007
II	225 000	157 500	292 500	13 500	.026	67 500	.005
JJ	300 000	210 000	390 000	18 000	.019	90 000	.004
KK	400 000	280 000	520 000	24 000	.015	120 000	.003
LL	560 000	392 000	728 000	33 600	.010	168 000	.002

**Notes:**

1. Round off to nearest Hz.
2. The indicated maximum data frequency response and minimum rise time is based on the maximum theoretical response that can be obtained in a bandwidth between the upper and lower frequency limits specified for the channels. See Appendix B, paragraph 3.0 for determining possible accuracy versus response tradeoffs.
3. Channels A through L may be used by omitting adjacent lettered and numbered channels. Channels 13 and A may be used together with some increase in adjacent channel interference.
4. Channels AA through LL may be used by omitting every four adjacent double lettered and lettered channels and every three adjacent numbered channels. Channels AA through LL may be used by omitting every three adjacent double lettered and lettered channels and every two adjacent numbered channels with some increase in adjacent channel interference.

3.3.2 Constant-Bandwidth FM Subcarrier Channel Characteristics. Table [3-2](#) lists the standard constant-bandwidth FM subcarrier channels. The letters A, B, C, D, E, F, G, and H identify the channels for use with maximum subcarrier deviations of  $\pm 2$ ,  $\pm 4$ ,  $\pm 8$ ,  $\pm 16$ ,  $\pm 32$ ,  $\pm 64$ ,  $\pm 128$ , and  $\pm 256$  kHz, along with maximum frequency responses of 2, 4, 8, 16, 32, 64, 128, and 256 kHz. The channels shall be used within the limits of maximum subcarrier deviation. See Appendix B for expected performance tradeoffs at selected combinations of deviation and modulating frequencies.

### **3.4 Tape Speed Control and Flutter Compensation**

Tape speed control and flutter compensation for FM/FM formats may be accomplished as indicated in subparagraph [6.8.4](#), Chapter 6. The standard reference frequency used shall be in accordance with the criteria in Table [3-3](#) when the reference signal is mixed with data.

**TABLE 3-2. CONSTANT-BANDWIDTH FM SUBCARRIER CHANNELS**

<b>Frequency Criteria \ Channels:</b>	<b>A</b>	<b>B</b>	<b>C</b>	<b>D</b>	<b>E</b>	<b>F</b>	<b>G</b>	<b>H</b>
Deviation Limits (kHz)	±2	±4	±8	±16	±32	±64	±128	±256
Nominal Frequency Response (kHz)	0.4	0.8	1.6	3.2	6.4	12.8	25.6	51.2
Maximum Frequency Response (kHz)	2	4	8	16	32	64	128	256
<p><b>Notes:</b></p> <p>The constant-bandwidth channel designation shall be the channel center frequency in kilohertz and the channel letter indicating deviation limit; for example, 16A, indicating <math>f_c = 16</math> kHz, deviation limit of ±2 kHz.</p> <p>The indicated maximum frequency is based upon the maximum theoretical response that can be obtained in a bandwidth between deviation limits specified for the channel. See discussion in Appendix B for determining practical accuracy versus frequency response trade offs.</p> <p>Prior to using a channel outside the shaded area, the user should verify the availability of range assets to support the demodulation of the channel selected. Very limited support is available above 2 MHz.</p>	<b>Center Frequency (kHz)</b>							
	8	16	32	64	128	256	512	1024
	16	32	64	128	256	512	1024	2048
	24	48	96	192	384	768	1536	3072
	32	64	128	256	512	1024	2048	
	40	80	160	320	640	1280	2560	
	48	96	192	384	768	1536	3072	
	56	112	224	448	896	1792	3584	
	64	128	256	512	1024	2048		
	72	144	288	576	1152	2304		
	80	160	320	640	1280	2560		
	88	176	352	704	1408	2816		
	96	192	384	768	1536	3072		
	104	208	416	832	1664	3328		
	112	224	448	896	1792	3584		
	120	240	480	960	1920	3840		
	128	256	512	1024	2048			
	136	272	544	1088	2176			
	144	288	576	1152	2304			
	152	304	608	1216	2432			
160	320	640	1280	2560				
168	336	672	1344	2688				
176	352	704	1408	2816				

**TABLE 3-3. REFERENCE SIGNAL USAGE**

Reference Frequencies for Tape Speed  
and Flutter Compensation

Reference Frequency  
(kHz  $\pm 0.01\%$ )

960 <sup>(1)</sup>  
480 <sup>(1)</sup>  
240 <sup>(1)</sup>  
200  
100  
50  
25  
12.5  
6.25  
3.125

**Note:** <sup>(1)</sup>These frequencies are for flutter compensation only and not for capstan servo speed control. In addition, the 240 kHz reference signal may be used as a detranslation frequency in a constant-bandwidth format.

If the reference signal is recorded on a separate tape track, any of the listed reference frequencies may be used provided the requirements for compensation rate of change are satisfied.

If the reference signal is mixed with the data signal, consideration must be given to possible problems with intermodulation sum and difference frequencies. Also, sufficient guard band must be allowed between the reference frequency and any adjacent data subcarrier.

This page intentionally left blank.

## CHAPTER 4

### PULSE CODE MODULATION STANDARDS

#### 4.1 General

Pulse code modulation (PCM) data are transmitted as a serial bit stream of binary-coded time-division multiplexed words. When PCM is transmitted, premodulation filtering shall be used to confine the radiated RF spectrum in accordance with Appendix A. These standards define pulse train structure and system design characteristics for the implementation of PCM telemetry formats. Additional information and recommendations are provided in Appendix C and in RCC Document 119, *Telemetry Applications Handbook*.

#### 4.2 Class Distinctions and Bit-Oriented Characteristics

The PCM formats are divided into two classes for reference. Serial bit stream characteristics are described below prior to frame and word oriented definitions.

4.2.1 Class I and Class II Distinctions. Two classes of PCM formats are covered in this chapter: the basic, simpler types are class I, and the more complex applications are class II. The use of any class II technique requires concurrence of the range involved. All formats with characteristics described in these standards are class I except those identified as class II. The following are examples of class II characteristics:

- bit rates greater than 5 megabits per second (see subparagraph [4.2.2.3](#))
- word lengths in excess of 16 bits (subparagraph [4.3.1.1](#))
- fragmented words (subparagraph [4.3.1.2](#))
- more than 8192 bits or 1024 words per minor frame (subparagraph [4.3.2.1.1](#))
- unevenly spaced supercommutation (subparagraph [4.3.2.4](#))
- format changes (paragraph [4.4](#))
- asynchronous embedded formats (paragraph [4.5](#))
- tagged data formats (paragraph [4.6](#))
- formats with data content other than unsigned straight binary, discretized, or complement arithmetic representation for negative numbers such as floating point variables, binary-coded decimal, and gain-and-value
- asynchronous data transmission (paragraph [4.8](#))
- merger of multiple format types (such as those specified in Chapter 8)





The use of fixed frame formats has been a common practice but does not fit all requirements. A verification of range capabilities should be made prior to incorporation of class II features into a telemetry system.

4.2.2 Bit-Oriented Definitions and Requirements. Definitions and requirements relating to serial PCM bit streams are described next.

4.2.2.1 Binary Bit Representation. The following code conventions for representing serial binary ones and zeros are the only permissible representations. Graphic and written descriptions of these conventions are shown in Figure 4-1. Only one convention shall be used within a single PCM bit stream. If Randomized NRZ-L (RNRZ-L) is transmitted it shall use the 15-bit regeneration pattern as described in Chapter 6 and Appendix D.

NRZ-L	Bi $\phi$ -L
NRZ-M	Bi $\phi$ -M
NRZ-S	Bi $\phi$ -S

4.2.2.2 Serial Bit Stream Transitions. The transmitted or recorded bit stream shall be continuous and shall contain sufficient transitions to ensure bit acquisition and continued bit synchronization, taking into account the binary representation chosen. (See recommendation in paragraph 1.3, Appendix C.)

4.2.2.3 Bit Rate. The RF and recording limits, defined in Chapters 2 and 6, should be considered when determining maximum bit rates. The minimum bit rate shall be 10 bps. Bit rates greater than 5 Mbps are class II.

4.2.2.4 Bit Rate Accuracy and Stability. During any period of desired data, the bit rate shall not differ from the specified nominal bit rate by more than 0.1 percent of the nominal rate.

4.2.2.5 Bit Jitter. The bit jitter shall not exceed  $\pm 0.1$  of a bit interval referenced to the expected transition time with no jitter. The expected transition time shall be based on the measured average bit period as determined during the immediately preceding 1000 bits.

### 4.3 Fixed Formats

Characteristics of fixed formats are described below. Fixed formats do not have changes during transmission with regard to frame structure, word length or location, commutation sequence, sample interval, or measurement list.

4.3.1 Word-Oriented Definitions and Requirements. The following definitions and requirements are addressed to word characteristics.

4.3.1.1 Word Length (Class I and II). Individual words may vary in length from 4 bits to not more than 16 bits in class I and not more than 64 bits in class II.

Code	Logic Waveform Levels	CODE WAVEFORMS	Code Definitions
NRZ-L		<p style="text-align: center;">1 0 1 1 0 0 0 1 1 0 1 0</p>	<p><u>Non Return to Zero - Level</u></p> <ul style="list-style-type: none"> <li>● “ONE” is represented by one level</li> <li>● “ZERO” is represented by the other level</li> </ul>
NRZ-M			<p><u>Non Return to Zero - Mark</u></p> <ul style="list-style-type: none"> <li>● “ONE” is represented by a change in level</li> <li>● “ZERO” is represented by <u>NO</u> change in level</li> </ul>
NRZ-S			<p><u>Non Return to Zero - Space</u></p> <ul style="list-style-type: none"> <li>● “ONE” is represented by <u>NO</u> change in level</li> <li>● “ZERO” is represented by a change in level</li> </ul>
Biφ-L			<p><u>Bi-Phase - Level<sup>(1)</sup></u></p> <ul style="list-style-type: none"> <li>● “ONE” is represented by a “ONE” level with transition to the “ZERO” level</li> <li>● “ZERO” is represented by a “ZERO” level with transition to the “ONE” level</li> </ul>
Biφ-M <sup>(2)</sup>			<p><u>Bi-Phase - Mark<sup>(1)</sup></u></p> <ul style="list-style-type: none"> <li>● “ONE” is represented by <u>NO</u> level change at the beginning of the bit period</li> <li>● “ZERO” is represented by a level change at the beginning of the bit period</li> </ul>
Biφ-S <sup>(2)</sup>			<p><u>Bi-Phase - Space<sup>(1)</sup></u></p> <ul style="list-style-type: none"> <li>● “ONE” is represented by a level change at the beginning of the bit period</li> <li>● “ZERO” is represented by a <u>NO</u> level change at the beginning of the bit period</li> </ul>

Figure 4-1. PCM code definitions.

**Notes:** (1) The Biφ codes may be derived from the corresponding NRZ codes by inverting the level for the last half of each bit interval.

(2) The definitions of the mark and space versions of the bi-phase code have been reversed in various editions of the *IRIG Telemetry Standards*. The Telemetry Group included both definitions in the 1986 and 1993 versions of the *Telemetry Standards*. In 106-96, the Telemetry Group replaced the 106-93 Biφ-M and Biφ-S definitions with the 106-93 DBiφ-S and DBiφ-M definitions. The 106-93 Biφ-M and DBiφ-S definitions were identical except for a possible inversion and a time delay of one-half bit period. The Biφ-S and DBiφ-M codes were identical with the same exceptions. The inversions do not change the data content, because the information is in the level changes (transitions) not the levels. The differential terminology and code designation have been dropped.

4.3.1.2 Fragmented Words (Class II). A fragmented word is defined as a word divided into no more than eight segments and placed in various locations within a minor frame. The locations need not be adjacent. All word segments used to form a data word are constrained to the boundaries of a single minor frame. Fragmented synchronization words are not allowed.

4.3.1.3 Bit Numbering. To provide consistent notation, the most significant bit in a word shall be numbered "one." Less significant bits shall be numbered sequentially within the word.

4.3.1.4 Word Numbering. To provide consistent notation, the first word after the minor frame synchronization pattern shall be numbered "one" (see Figure 4-2). Each subsequent word shall be numbered sequentially within the minor frame. Numbering within a subframe (see subparagraph 4.3.2.3.1) shall be "one" for the word in the same minor frame as the initial counter value for subframe synchronization and sequentially thereafter. Notations of W and S shall mean the W word position in the minor frame and S word position in the subframe.

4.3.2 Frame Structure. The PCM data shall be formatted into fixed length frames as defined in these sections regarding frame structure and in Figure 4-2. Frames shall contain a fixed number of equal duration bit intervals.

4.3.2.1 Minor Frame. The minor frame is defined as the data structure in time sequence from the beginning of a minor frame synchronization pattern to the beginning of the next minor frame synchronization pattern.

4.3.2.1.1 Minor Frame Length (Class I and II). The minor frame length is the number of bit intervals from the beginning of the frame synchronization pattern to the beginning of the next synchronization pattern. The maximum length of a minor frame shall neither exceed 8192 bits nor 1024 words in class I and shall not exceed 16 384 bits in class II.

4.3.2.1.2 Minor Frame Composition. The minor frame shall contain the minor frame synchronization pattern, data words, and subframe synchronization words, if used. Words of different length may be multiplexed in a single minor frame. The length of a word in any identified word position within a minor frame shall be constant. Other words such as frame format identifiers may be needed within class II formats (see paragraph 4.4).

4.3.2.1.3 Minor Frame Synchronization. The minor frame synchronization information shall consist of a fixed digital word not longer than 33 consecutive bits and not shorter than 16 bits. Recommended synchronization patterns are given in Table C-1, Appendix C.

4.3.2.1.4 Transmitted Frame Counter. The frame counter provides a natural binary count corresponding to the minor frame number in which the frame count word appears. It is recommended that such a counter be included in all minor frames whether class I or class II and is especially desirable in class II formats to assist with data processing. The frame counter should be of nominal format word length and reset to start up-counting again after reaching maximum value. In formats where subcommutation is present, the subframe ID counter may serve as the frame counter.

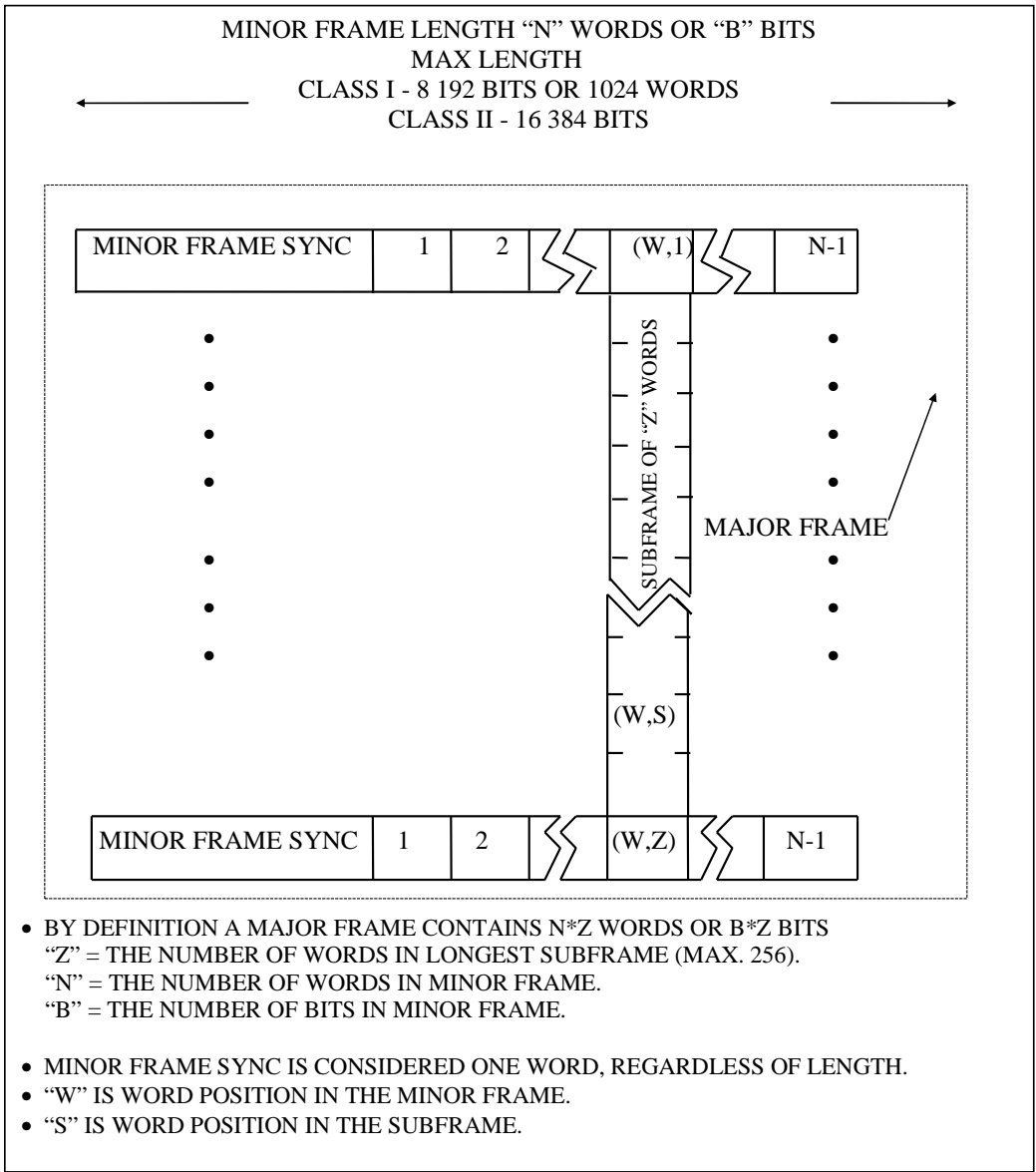

Figure 4-2. PCM frame structure.

4.3.2.2 Major Frame. A major frame contains the number of minor frames required to include one sample of every parameter in the format.

4.3.2.2.1 Major Frame Length. Major frame length is defined as minor frame length (N words or B bits) multiplied by the number of minor frames (Z) in the major frame. The maximum number of minor frames per major frame shall not exceed 256.

4.3.2.2.2 Minor Frame Numbering. To provide consistent notation, the first minor frame in a major frame shall be numbered "one." Each subsequent minor frame shall be numbered sequentially within the major frame.

4.3.2.3 Subcommutation. Subcommutation is defined as a sampling of parameters at submultiple rates ( $1/D$ ) of the minor frame rate where the depth of a subframe, D, is an integer in the range of 2 to Z.

4.3.2.3.1 Subframe. Subframe is defined as one cycle of the parameters from a subcommutated minor frame word position. The depth, D, of a subframe is the number of minor frames in one cycle before repetition.

4.3.2.3.2 Subframe Synchronization Method. The standard method for subframe synchronization is to use a "subframe ID counter," a binary counter which counts sequentially up or down at the minor frame rate. The counter shall be located in a fixed position in each and every minor frame. A subframe ID counter should start with the minimum counter value when counting up or the maximum counter value when counting down. The counter should also be left or right justified in a word position. The start of a major frame shall coincide with the initial count for the deepest subframe.

4.3.2.4 Supercommutation. Supercommutation ("supercom") is defined as time-division-multiplex sampling at a rate that is a multiple of the minor frame rate. Supercommutation (on a minor frame) provides multiple samples of the same parameter in each minor frame. "Supercom on a subframe" is defined as time-division-multiplex sampling at a rate that is a multiple of the subframe rate and provides multiple samples of the same parameter within a subframe. For class I, supercommutated samples shall be evenly spaced. For class II, supercommutated samples should be as evenly spaced as practical.

#### **4.4 Format Change (Class II)**

Format change is defined as change with regard to frame structure, word length or location, commutation sequence, sample interval, or change in measurement list. Format changes shall occur only on minor frame boundaries. Bit synchronization shall be maintained and fill bits used instead of intentional dead periods. Format changes are inherently disruptive to test data processing; fixed format methods are preferred. Format change methods shall conform to the characteristics described in the following sections.

4.4.1 Frame Format Identification. A frame format identifier (FFI) is a word that shall uniquely identify a single format. In formats where change is required, the frame format identifier shall be placed in every minor frame. The format identifier shall be the same length as (or multiples of) the most common word length in the format and shall occur in a fixed position in the minor frame. The FFI shall identify the format applicable to the current minor frame. Frame synchronization pattern, FFI location, bit rate, and binary bit representation code shall not be changed. The FFI shall be constructed such that a single bit error cannot produce another valid FFI. The number of unique formats indicated shall not exceed 16.

4.4.2 Format Change Implementation Methods. The following subparagraphs describe format change implementation methods.

4.4.2.1 Measurement List Change. This method of format change consists of a modification in data content only and not format structure.

4.4.2.2 Format Structure Change. Defined as a format change where there is a departure in frame structure and not just data content.

#### **4.5 Asynchronous Embedded Format (Class II)**

Defined as a secondary data stream asynchronously embedded into a host major frame in a manner that does not allow predicting the location of embedded synchronization information based only on host format timing. The embedded frame segments shall be inserted as an integral number of words in every host minor frame. In this combined format, specific word positions in the host minor frame shall be dedicated to the embedded asynchronous format. No more than two asynchronous embedded formats are permitted.

#### **4.6 Tagged Data Format (Class II)**

Defined as a fixed frame length format having no applicable subframe or major frame definitions and characterized as a stream of data words, or blocks of words, with associated identifiers (tags). These formats consist of frame synchronization patterns, identifiers, data words, and fill words as required.

4.6.1 Alternating Tag and Data. This tagged data format consists of frames containing tag words alternating in time sequence with data words or blocks of words identified by the tags.

4.6.2 Bus Data Military Standard (MIL-STD) 1553.<sup>12</sup> Telemetry of MIL-STD 1553 information is preferred to be restructured to conform to class I methods. If not, telemetered MIL-STD 1553 data shall conform to Chapter 8, paragraph [8.6](#).

---

<sup>12</sup> Defined in MIL-HDBK-1553A(2), 1995, *Multiplex Applications Handbook*.

## 4.7 Time Words

The following paragraphs describe the formatting of time words within a PCM stream. A 16-bit standardized time word format and a method to insert time words into PCM word sizes other than 16-bits are described.

4.7.1 In 16-bit standardized time word format, there shall be three words dedicated to providing timing information. These words are designated high order time, low order time, and microsecond time. High and low order time words shall be binary or binary coded decimal (BCD) weighted, and microsecond words shall be binary weighted. Time word construction examples are shown in Figure [4-3](#) and Figure [4-4](#).

4.7.2 The microsecond time word shall have a resolution of 1 microsecond; that is, the least significant bit, bit 16, has a value of 0.000001 second. This word shall increment until it attains a value of 10 milliseconds at which time it will reset to zero. Thus the maximum value of the counter is 9999 (decimal).

4.7.3 The low order time word shall have a resolution of 10 milliseconds; that is, the least significant bit, bit 16, of the low order time word shall have a value of 0.010 second.

4.7.4 The high order time word shall have a resolution of 655.36 seconds when binary weighted; that is, the least significant bit, bit 16, has a value of 655.36 seconds. When BCD weighted, the least significant bit, bit 16, of the high order time word shall have a value of one minute. For BCD, the days field shall contain the three least significant characters of the BCD Julian date.

4.7.5 It is recommended that high, low, and microsecond time words precede the first data word in the minor frame. The time word order shall be high order time word, followed by low order time word, followed by microsecond time word. Microsecond time words may be used to tag individual data words, but care shall be taken that high order and low order time words be inserted at a rate necessary to resolve time ambiguities.

4.7.6 Time word insertion into PCM word sizes other than 16 bits shall be as follows: high order, low order, and microsecond time words shall be inserted into PCM words with time word bits occupying contiguous bit locations in the PCM word. The time word shall occupy contiguous PCM data words until the time word is contained in the PCM stream. If the time word size is not an integer multiple of the PCM word size and there are unused bits in the PCM word, the remaining unused bits in the last PCM word that contains the time word shall be fill bits with value 0. Figure [4.4](#) illustrates the insertion of time words into a PCM stream with word size of 12 bits.

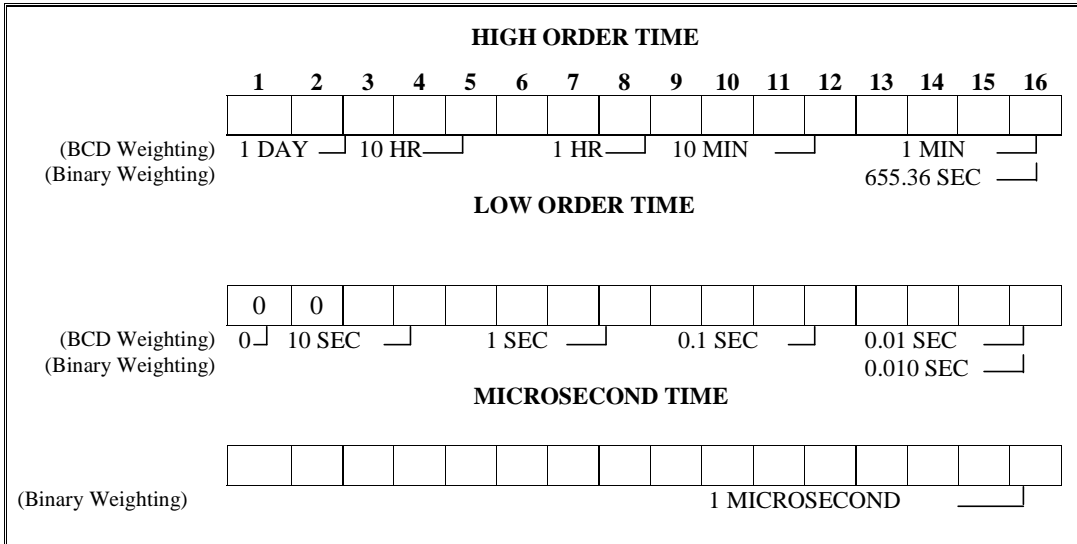

Figure 4-3 16 bit standardized time word format.

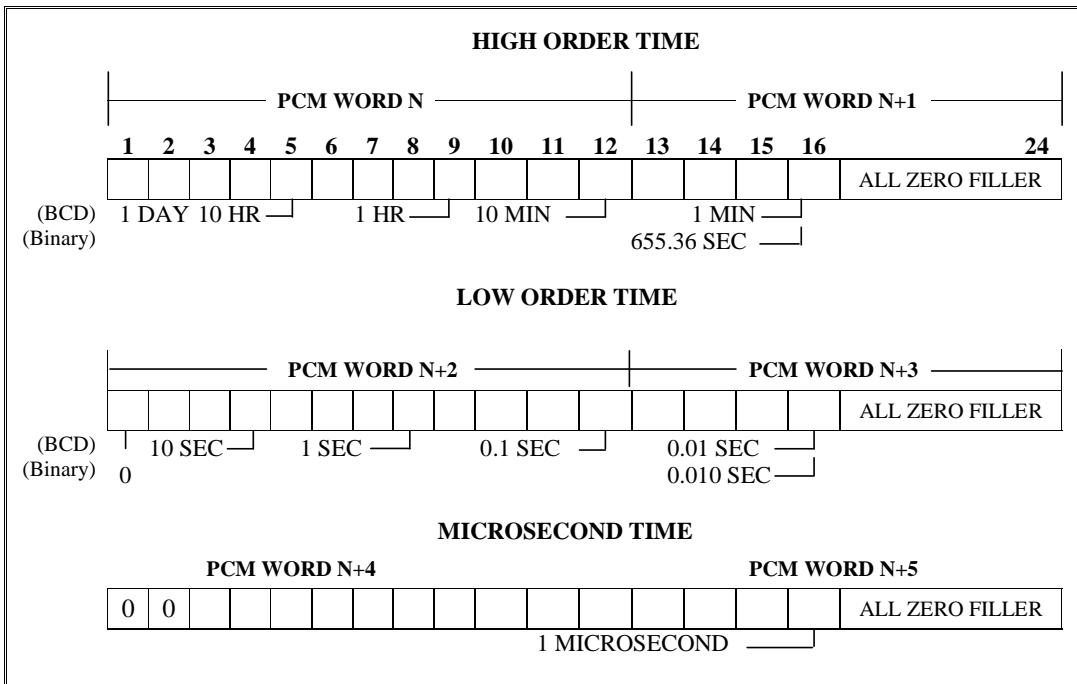

Figure 4-4. Time word insertion into 12 bit PCM word size.



## 4.8 Asynchronous Data Merge

Asynchronous data is defined as an external sequential data stream (consisting of data bits, associated overhead, and optional parity, all at an autonomous update rate) which is a candidate for insertion into a primary or "host" PCM format. Common examples are RS-232 serial and IEEE-488 parallel messages. Each source of such data shall use fixed word positions in the host format. This section does not apply to secondary PCM formats which are to be embedded as described in paragraph 4.5. Merger shall comply with subparagraph 4.2.2 and the following conventions.

4.8.1 PCM Data Word Format. Figure 4-5 illustrates the host PCM format word containing a merged asynchronous data word and associated overhead which is referred to as an "asynchronous word structure." The data may be inserted in any length PCM word that will accommodate the required bits. Asynchronous data shall not be placed in fragmented words. Multiple host PCM format words, if used, shall be contiguous.

4.8.2 Insertion Process. The asynchronous word structure shall contain the information from the asynchronous message partitioned into two fields, data and overhead, as shown in figure 4-5. The asynchronous message is inserted into the asynchronous word structure with the following bit orientations. The most significant data bit (MSB) through least significant data bit (LSB) and parity (if used) of the message are denoted as  $D_1$  (MSB) through  $D_i$  and will be inserted into structure bits  $B_1$  (MSB) through  $B_i$ . The next two structure bits,  $B_{(i+1)}$  and  $B_{(i+2)}$  are reserved for the stale and overflow flags generated by the host encoder. All remaining overhead (message and host encoder generated)  $D_{(i+3)}$  through  $D_n$  (LSB), will be inserted into structure bits  $B_{(i+3)}$  through  $B_n$  (LSB).

4.8.2.1 Transmission Overhead. All transmission overhead not required for data reconstruction shall be removed.

4.8.2.2 Parity Bit. Transmission of a parity bit is optional. If it is transmitted, it shall be at the end of the data field (see Figure 4-5) adjacent to the LSB of the data.

4.8.2.3 Data Bits. The data bits shall be inserted into the PCM word with the most significant bit of the asynchronous data aligned with the most significant bit of the PCM word.

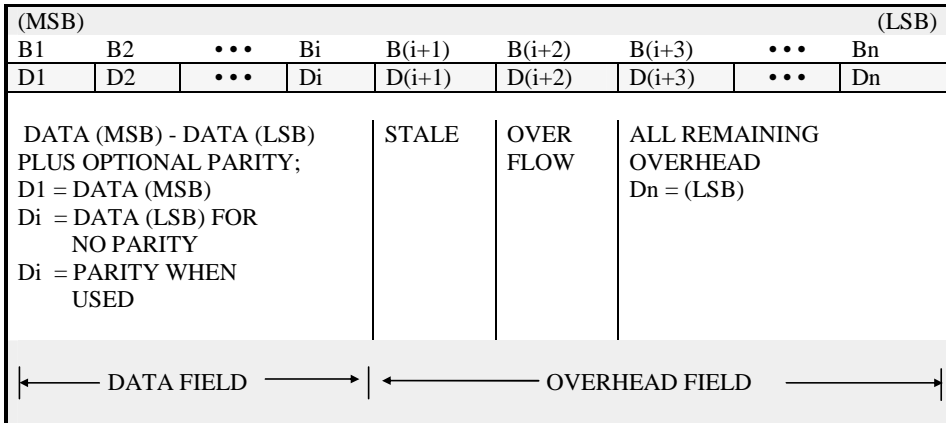

Figure 4-5. Asynchronous word structure.

4.8.2.4 Stale Data Bit. A “stale data bit” flag shall be generated each time a new data value is inserted into the PCM stream. The flag shall be transmitted with the associated data. The flag bit shall be placed in the next less significant bit location following the LSB of the data. If new data is not ready for transmission by the time the PCM word must be sent again, either the old data or alternating one/zero fill shall be sent and the flag set. Stale data shall be indicated by a binary “one” (see Figure 4-6).

STALE BIT	OVERFLOW BIT	
0	0	FRESH DATA
0	1	DATA OVERFLOW
1	0	STALE DATA
1	1	USER DEFINED

Figure 4-6 Overhead truth table.

4.8.2.5 Overflow Bit. An “overflow bit” flag shall be generated to indicate an abnormal condition in which data may be lost. The overflow bit shall be placed in the next less significant data bit location following the stale bit flag. An overflow bit at a binary “one” indicates that a data discontinuity exists between the current data word and the previous data word (see Figure 4-6).

4.8.2.6 Insertion Rate. The asynchronous word structure shall be inserted into the host PCM word at a rate to avoid data loss in the PCM stream.

This page intentionally left blank.

## CHAPTER 5

### DIGITIZED AUDIO TELEMETRY STANDARD

#### 5.1 General

This chapter defines continuous variable slope delta (CVSD) modulation as the standard for digitizing audio and addresses the method of inserting CVSD encoded audio into a PCM stream. Additional information and recommendations are provided in Appendix F, Continuous Variable Slope Delta Modulation. Appendix F was extracted from the applicable sections of MIL-STD-188-113.

#### 5.2 Definitions

For the purpose of this standard, the following definitions apply.

5.2.1 Band-Limited Audio. An audio signal (typically consisting of voice, tones, and sounds) that is limited to a subset of the audio spectrum. For most aircraft audio applications, the spectrum between 100 and 2300 hertz is adequate.

5.2.2 Continuous Variable Slope Delta Modulation. The CVSD modulation is a method of digitizing a band-limited audio signal. The CVSD modulator is, in essence, a 1-bit analog-to-digital converter. The output of this 1-bit encoder is a serial bit stream, where each bit represents an incremental increase or decrease in signal amplitude and is determined as a function of recent sample history.

#### 5.3 Signal Source

The signal to be encoded shall be a band-limited audio signal. The source of this signal may be varied. Some examples are microphones, communication systems, and tones from warning systems. This standard applies to audio signals only.

#### 5.4 Encoding/Decoding Technique

The technique to encode and decode the band-limited audio signal is CVSD modulation. This technique is to be implemented in accordance with Appendix F.

A CVSD converter consists of an encoder-decoder pair. The decoder is connected in a feedback path. The encoder receives a band-limited audio signal and compares it to the analog output of the decoder. The result of the comparison is a serial string of "ones" and "zeros." Each bit indicates that the band-limited audio sample's amplitude is above or below the decoded signal. When a run of three identical bits is encountered, the slope of the generated analog approximation is increased in its respective direction until the identical string of bits is broken. The CVSD decoder performs the inverse operation of the encoder and regenerates the audio signal.



A qualitative test of CVSD with a tactical aircraft intercom system (ICS) yielded the following results: (1) intelligible, robotic sounding audio at 12 kilobits/second; (2) good quality audio at 16 kilobits/second; and (3) audio quality did not significantly improve as the bit rate was increased above 32 kilobits/second.

### 5.5 CVSD Encoder Output Bit Rate (CVSD Bit Rate)

The CVSD bit rate for encoding the band-limited audio signal is a function of the desired audio quality and the PCM format characteristics. The minimum and maximum CVSD bit rates will not be specified.

Appendix F contains performance criteria for the CVSD encoder and decoder when operated at 16 or 32 kilobits/second.

### 5.6 CVSD Word Structure

The digitized audio signal from the CVSD encoder's serial output shall be inserted into the PCM stream as shown in Figure 5-1. The most significant bit (MSB) shall be the most stale sample (first in). The least significant bit (LSB) shall be the most recent sample (last in).

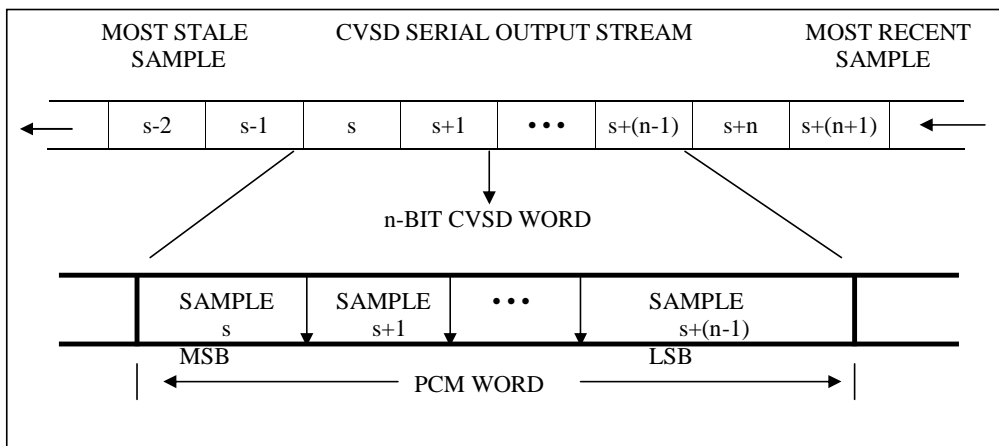

Figure 5-1. Insertion of CVSD encoded audio into a PCM stream.

## 5.7 CVSD Word Sample Rate

The CVSD word sample rate is dependent on the minimum desired CVSD bit rate, the PCM word length, and the PCM word sample rate. Once the CVSD word sample rate is determined, the actual CVSD bit rate can be calculated. The decoder must be run at the same CVSD bit rate as the encoder.



Because of the nature of CVSD encoding, over and under sampling of the CVSD output will have unpredictable results.



To simplify the reconstruction of the audio signal and minimize all encoding/decoding delays, it is **STRONGLY** recommended that the digitized audio words be inserted in the PCM stream at evenly spaced intervals.

## 5.8 CVSD Bit Rate Determination

The following discussion provides a procedure for determining the CVSD bit rate based on the desired minimum CVSD bit rate and information given in the host PCM format. Note that this procedure assumes the CVSD words are inserted in a class I PCM format with constant word widths and are not subcommutated. The CVSD bit rate can be obtained by multiplying the minor frame rate by the number of times the CVSD words appear in the minor frame by the word width used for the CVSD words in the minor frame. This relationship is expressed in equation (5-1).

$$\text{CVSD BIT RATE} = \text{MINOR FRAME RATE} \cdot \# \text{CVSD WORDS PER MINOR FRAME} \cdot \text{WORD WIDTH} \quad (5-1)$$

Knowing the details on the host PCM format, equation (5-1) contains two unknowns: CVSD BIT RATE and #CVSD WORDS PER MINOR FRAME. One of these unknowns must be chosen by the user, then the other one can be calculated. The recommended procedure is to choose the desired (target value) CVSD bit rate and solve equation (5-1) for #CVSD WORDS PER MINOR FRAME. This relationship is expressed in equation (5-2).

$$\# \text{CVSD WORDS PER MINOR FRAME}_{\text{calculated}} = \frac{\text{DESIRED CVSD BIT RATE}}{\text{MINOR FRAME RATE} \cdot \text{WORD WIDTH}} \quad (5-2)$$

Next, round up (if required) the result of equation (5-2) to the nearest integer. To satisfy the evenly spaced recommendation, round up (if required) to the nearest integer that divides evenly into the number of PCM words per minor frame.

Finally, for either case, substitute the result of equation (5-2) back into equation (5-1) to determine the actual CVSD bit rate. To illustrate this procedure, consider the following numerical example for determining the CVSD bit rate. An existing PCM format has the following characteristics:

Bit rate = 192 000 bits/second  
 Word width = 12 bits/word  
 Minor frame rate = 100 frames/second  
 Words/ minor frame = 160 words/minor frame

To insert a serial CVSD bit stream with a desired (target value), CVSD bit rate of 16 000 bits/second will require the following procedure. Based on the information given, use equation (5-2) to calculate the #CVSD WORDS PER MINOR FRAME.

$$\# \text{CVSD WORDS PER MINOR FRAME}_{\text{CALCULATED}} = \frac{\text{DESIRED CVSD BIT RATE}}{\text{MINOR FRAME RATE} \bullet \text{WORD WIDTH}}$$

$$\# \text{CVSD WORDS PER MINOR FRAME}_{\text{CALCULATED}} = \frac{16\,000 \text{ (bits/sec)}}{100 \text{ (frames/sec)} \bullet 12 \text{ (bits/word)}}$$

$$\# \text{CVSD WORDS PER MINOR FRAME}_{\text{CALCULATED}} = 13.3 \text{ (words/frame)}$$

Rounding up the #CVSD WORDS PER MINOR FRAME to the nearest integer yields 14. In this example, there are 160 PCM words in the minor frame. If the user needs to satisfy the evenly spaced criteria, then by inspection, the #CVSD WORDS PER MINOR FRAME will be rounded up to 16. For comparison, both cases will be substituted into equation (5-1) to yield the actual CVSD bit rate.

**CASE 1:** (unevenly spaced CVSD samples, NOT RECOMMENDED)

$$\# \text{CVSD WORDS PER MINOR FRAME}_{\text{CALCULATED}} = 14 \text{ (words/frame)}$$

$$\text{CVSD BIT RATE} = \text{MINOR FRAME RATE} \bullet \# \text{CVSD WORDS / MINOR FRAME} \bullet \text{WORD WIDTH}$$

$$\text{CVSD BIT RATE}_{\text{ACTUAL}} = 100 \text{ (frames/sec)} \bullet 14 \text{ (words/frame)} \bullet 12 \text{ (bits/word)}$$

$$\text{CVSD BIT RATE}_{\text{ACTUAL}} = 16\,800 \text{ (bits/sec)}$$

CASE 2: (evenly spaced samples, RECOMMENDED)

# CVSD WORDS PER MINOR FRAME <sub>CALCULATED</sub> = 16 (*words/frame*)

CVSD BIT RATE = MINOR FRAME RATE • # CVSD WORDS PER MINOR FRAME • WORD WIDTH

CVSD BIT RATE <sub>ACTUAL</sub> = 100 (*frames/sec*) • 16 (*words/frame*) • 12 (*bits/word*)

CVSD BIT RATE <sub>ACTUAL</sub> = 19 200 (bits/sec)



This page intentionally left blank.

## CHAPTER 6

### MAGNETIC TAPE RECORDER AND REPRODUCER STANDARDS

#### 6.1 Introduction

These standards define terminology for longitudinal, fixed-head recorder and reproducer systems and establish the recorder and reproducer configuration required to ensure crossplay compatibility between tapes recorded at one facility and reproduced at another. Standards for 19-millimeter digital cassette helical scan and ½-inch digital cassette (S-VHS) helical scan recording systems are also included along with the associated multiplexer/demultiplexer systems. Acceptable performance levels and a minimum of restrictions consistent with compatibility in interchange transactions are delineated. While the standards may serve as a guide in the procurement of magnetic tape recording equipment, they are not intended as substitutes for purchase specifications. Other standards have been prepared by the American National Standards Institute (ANSI) and the International Standards Organization (see paragraph 1.0, Appendix D).

Wherever feasible, quantitative performance levels are given which must be met or exceeded to comply with these standards. Standard test methods and measurement procedures shall be used to determine such quantities, including those contained in Volume III of RCC Document 118, *Test Methods for Recorder/Reproducer Systems and Magnetic Tape*.

United States (U.S.) engineering units are the original dimension in these standards. Conversions from U.S. engineering units (similar to British Imperial Units) to Système International d Unités (SI) units have been done according to ASTM SI 10 (1996) except as noted. Standards applying to magnetic tapes are contained in Chapter 7 of this document.

#### 6.2 Definitions

5/6 modulation code. A method of encoding whereby a 5-bit data group is converted to a 6-bit code frame in accordance with a conversion table. Such coding is performed to control the frequency content of the data stream.

Basic dimension. A dimension specified on a drawing as *basic* is a theoretical value used to describe the exact size, shape, or location of a feature. It is used as the basis from which permissible variations are established by tolerances on other dimensions.

Bias signal, high frequency. A high-frequency sinusoidal signal linearly added to the analog data signal in direct recording to linearize the magnetic recording characteristic.

Bi-phase. A method of representing "one" or "zero" levels in PCM systems where a level change is forced to occur in every bit period. In bi-phase recording, the bi-phase level (split-phase) method is employed.

Bit error. In PCM systems, a bit error has occurred when the expected bit value is not present; for example, a zero is present when a one is expected, or a one is present when a zero is expected.

Bit error rate (BER). Number of bits in error in a predetermined number of bits transmitted or recorded, for example, 1 in  $10^6$  or a BER of  $10^{-6}$ .

Bit packing density, linear. Number of bits recorded per inch or per millimeter of tape length. For serial PCM recording, the number of bits per unit length of a single track.

Bit slip. The increase or decrease in detected bit rate by one or more bits with respect to the actual bit rate.

Code frame. An ordered and contiguous set of bits (symbol) that results as a unit from the process of modulation coding.

Code word digital sum (CWDS). Denotes the digital sum variation of one modulation code frame (symbol).

Crossplay. Reproducing a previously recorded tape on a recorder and reproducer system other than that used to record the tape.

Crosstalk. Undesired signal energy appearing in a reproducer channel as a result of coupling from other channels.

Data azimuth (dynamic). The departure from the head segment gap azimuth angles (static) because of the dynamic interface between the heads and the moving tape.

Data scatter. The distance between two parallel lines (as defined under *gap scatter*) in the plane of the tape, which contains all data transitions recorded simultaneously with the same head at the same instant of time.

Data spacing. For interlaced head systems, the distance on tape between simultaneous events recorded on odd and even heads.

Digital sum variation (DSV). Indicates the integral value that is counted from the beginning of the modulation coded waveform, taking a high level as 1 and a low level as -1.

Direct Recording (ac Bias Recording). A magnetic recording technique employing a high-frequency bias signal that is linearly added to the data signal. The composite signal is then used as the driving signal to the record-head segment. The bias signal, whose frequency is well above the highest frequency that can be reproduced by the system, transforms the recording of the data signal so that it is a more nearly linear process.

Double-density recording. Direct, FM, or PCM recording on magnetic tape at bandwidths equal to those used in wide-band instrumentation recording, but at one-half the wide-band tape speeds

specified in IRIG standard 106-80 and earlier telemetry standards. Special record and reproduce heads and high output tapes (see Chapter 7) are required for double-density recording.

Dropout. An instantaneous decrease in reproduced signal amplitude of a specified amplitude and duration.

ECC code word. The group of symbols resulting from ECC encoding including the data symbols and the check symbols appended.

Edge margin. The distance between the outside edge of the highest number track and the tape edge (see Figure 6-1).

Edge margin minimum. The minimum value of edge margin.

Error correcting code (ECC). A mathematical procedure yielding bits used for the detection and correction of errors.

FM recording. Recording on magnetic tape using frequency-modulated record electronics to obtain response from dc to an upper specified frequency. The FM systems forfeit upper bandwidth response of direct record systems to obtain low frequency and dc response not available with direct recording.

Flux transition. A 180-degree change in the flux pattern of a magnetic medium brought about by a reversal of poles within the medium.

Flux transition density. Number of flux transitions per inch or per millimeter of track length.

Flutter. Undesired changes in the frequency of signals during the reproduction of a magnetic tape produced by speed variations of the magnetic tape during recording or reproducing.

Gap azimuth. The angular deviation, in degrees of arc, of the recorded flux transitions on a track from the line normal to the track centerline.

Gap length (physical). The dimension between leading and trailing edges of a record or reproduce head-segment gap measured along a line perpendicular to the leading and trailing edges of the gap.

Gap scatter (record head). The distance between two parallel lines is defined in the following subparagraphs.

- a. The two lines pass through the geometric centers of the trailing edges of the two outermost head segment gaps within a record head. The geometric centers of the other head segment gap trailing edges lie between the two parallel lines.
- b. The two parallel lines lie in the plane of the tape and are perpendicular to the head reference plane (see Figure 6-3).

Gap scatter (reproduce head). Defined the same as for record-head gap scatter except that the reference points for reproduce heads are the geometric centers of the center lines of the head segment gaps (see Figure 6-3).

Guard band. The unrecorded space between two adjacent recorded tracks on the magnetic tape.

Head (record or reproduce). A group of individual head segments mounted in a stack.

Head designation. For interlaced heads, the first head of a record or reproduce pair over which the tape passes in the forward direction containing odd-numbered head segments and referred to as the odd head. The second head containing even-numbered head segments is the even head. For non-interlaced heads (in-line heads), both odd- and even-numbered head segments are contained within a single head.

Heads, in-line. A single record head and a single reproduce head are employed. Odd and even record-head segment gaps are in-line in the record head. Odd and even reproduce-head segment gaps are in-line in the reproduce head.

Head reference plane. The plane, which may be imaginary, is parallel to the reference edge of the tape and perpendicular to the plane of the tape. For purposes of this definition, the tape shall be considered as perfect (see Figures 6-2 and 6-3).

Head segment, record or reproduce. A single transducer that records or reproduces one track (see Figure 6-3).

Head segment gap azimuth (record or reproduce heads). The angle formed in the plane of the tape between a line perpendicular to the head reference plane and a line parallel to the trailing edge of the record-head segment gap or parallel to the centerline of the reproduce-head segment gap.

Head segment gap azimuth scatter. The angular deviations of the head segment gap azimuth angles within a head.

Head segment numbering. Numbering of a head segment corresponds to the track number on the magnetic tape on which that head segment normally operates. For interlaced heads, the odd head of a pair contains all odd-numbered segments, while the even head will contain all even-numbered segments (see Figure 6-2). In-line heads will contain odd and even segments in the same head stack.

Head spacing. For interlaced head systems, the distance between odd and even heads.

Head tilt. The angle between the plane tangent to the front surface of the head at the center line of the head segment gaps and a line perpendicular to the head reference plane (see Figure 6-3).

Heads, interlaced. Two record heads and two reproduce heads are employed. Head segments for alternate tracks are in alternate heads.

Helical track. A diagonally positioned area on the tape along which a series of magnetic transitions is recorded.

High-density digital recording. Recording of digital data on a magnetic medium resulting in a flux transition density in excess of 590 transitions per millimeter (15 000 transitions per inch) per track.

Individual track data azimuth difference. Angular deviation of the data azimuth of an individual odd or even recorded track from the data azimuth of other odd or even tracks. The difficulty in making direct optical angular measurements requires this error to be expressed as a loss of signal amplitude experienced when the tape is reproduced with an ideal reproducing head, whose gap is aligned to coincide with the data azimuth of all tracks in one head as compared to the azimuth which produces maximum signal for an individual track (see Figure [6-3](#)).

Interleaving. The systematic reordering of data so that originally adjacent ECC code word symbols are separated, thus reducing the effect of burst errors on the error correcting capability.

Non-return-to-zero level. A binary method of representation for PCM signals where one is represented by one level, and zero is defined as the other level in a bi-level system.

Physical recording density. The number of recorded flux transitions per unit length of track, for example, flux transitions per millimeter (ftpmm).

Principal block. Denotes a group of helical tracks recorded on the tape in one complete rotation of the scanner.

Principal block number (PBN). A unique number assigned to and recorded in each principal block.

Record level set frequency. Frequency of a sinusoidal signal used to establish the standard record level in direct-record systems. Normally, 10 percent of the upper band edge (UBE) frequency.

Reference tape edge. When viewing a magnetic tape from the oxide surface side with the earlier recorded portion to the observer's right, the reference edge is the top edge of the tape (see Figure [6-1](#)).

Reference track location. Location of the centerline of track number 1 from the reference edge of tape.

Scanner. The rotating assembly housing the helical heads around which the tape is applied thereby accomplishing the recording of helical tracks on the tape.

Standard record level. For a magnetic tape recorder meeting IRIG standards and operating in the direct record mode, the input signal level produces 1 percent third harmonic distortion of the record level set frequency.

Tape skew. Motion of a magnetic tape past a head such that a line perpendicular to the tape reference edge has an angular displacement (static or dynamic) from the head gap centerlines.

Tape speed, absolute. The tape speed during recording and reproducing. The peripheral velocity of the capstan minus any tape slip, regardless of tape tension and environment.

Tape speed, effective. The tape speed modified by the effects on tape of operating conditions such as tension, tape materials, thickness, temperature, and humidity. The effective tape speed should be equal to the selected speed of the recorder, for example, 1524 mm/s (60 ips), 3048 mm/s (120 ips), regardless of operating conditions.

Tape speed errors. Errors are the departures of the effective speed from the selected tape speed.

Track angle. The angular deviation, in degrees of arc, of the centerline of the recorded helical track from the tape reference edge.

Track location. Location of the nth track centerline from the reference track centerline.

Track numbering. The reference track is designated as track number 1. Tracks are numbered consecutively from the reference track downward when viewing the oxide surface of the tape with the earlier recorded portion of the tape to the observer's right (see Figure 6-1).

Track spacing. Distance between adjacent track centerlines on a magnetic tape (see Figure 6-1).

Track width. The physical width of the common interface of the record-head segment at the gaps. This definition does not include the effects of fringing fields, which will tend to increase the recorded track width by a small amount.

Volume label. A group of bits used to provide an identifying code for a tape cartridge.

### **6.3 General Considerations for Longitudinal Recording**

Standard recording techniques, tape speeds, and tape configurations are required to provide maximum interchange of recorded telemetry magnetic tapes between the test ranges. Any one of the following methods of information storage or any compatible combination may be used simultaneously: direct recording, predetection recording, FM recording, or PCM recording. Double-density recording may be used when the length of recording time is critical; however, it must be used realizing that performance parameters such as signal-to-noise ratio, crosstalk, and dropouts may be degraded (see paragraph 2.0, Appendix D).

6.3.1 Tape Speeds. The standard tape speeds for instrumentation magnetic tape recorders are shown in Table 6-1.

6.3.2 Tape Width. The standard nominal tape width is 25.4 mm (1 in.) (see Table [7-1](#), Tape Dimensions).

6.3.3 Record and Reproduce Bandwidths. For the purpose of these standards, two system bandwidth classes are designated: wide band and double density (see Table [6-1](#)). Interchange of tapes between the bandwidth classes is **NOT** recommended.

#### **6.4 Recorded Tape Format**

The parameters related to recorded tape format and record and reproduce head configurations determine compatibility between systems that are vital to interchangeability (crossplay) of recorded magnetic tapes. Refer to the definitions in paragraph [6.2](#), Figures [6-1](#) through 6-4 and Tables [6-2](#) through 6-4. See Appendix D for configurations not included in these standards.

6.4.1 Track Width and Spacing. Refer to Figure [6-1](#) and Tables [6-2](#) through 6-4.



**TABLE 6-1. RECORD AND REPRODUCE PARAMETERS**

<b>Tape Speed</b> {mm/s (ips)}	<b>±3 dB Reproduce</b> <b>Passband</b> KHz <sup>(1)</sup>	<b>Direct Record Bias</b> <b>Set Frequency</b> {(UBE) kHz <sup>(2)</sup> }	<b>Level Set Frequency</b> {10% of UBE (kHz)}
<b><u>Wide Band</u></b>			
6096.0 (240 )	0.8-4000	4000	400
3048.0 (120 )	0.4-2000	2000	200
1524.0 ( 60 )	0.4-1000	1000	100
762.0 ( 30 )	0.4- 500	500	50
381.0 ( 15 )	0.4- 250	250	25
190.5 ( 7-1/2)	0.4- 125	125	12.5
95.2 ( 3-3/4)	0.4- 62.5	62.5	6.25
47.6 ( 1-7/8)	0.4- 31.25	31.25	3.12
<b><u>Double Density</u></b>			
<b>(Overbias 2 dB)</b>			
3048.0 (120 )	2 -4000	4000	400
1524.0 ( 60 )	2 -2000	2000	200
762.0 ( 30 )	2 -1000	1000	100
381.0 ( 15 )	2 - 500	500	50
190.0 ( 7-1/2)	1 - 250	250	25
95.2 ( 3-3/4)	0.5- 125	125	12.5

**Notes:**

<sup>(1)</sup> Passband response reference is the output amplitude of a sinusoidal signal at the record level set frequency recorded at standard record level. The record level set frequency is 10 percent of the upper band edge frequency (0.1 UBE).

<sup>(2)</sup> When setting record bias level, a UBE frequency input signal is employed. The signal input level is set 5 to 6 dB below standard record level to avoid saturation effects which could result in erroneous bias level settings. The record bias current is adjusted for maximum reproduce output level and then increased until the output level decreases by the number of dB indicated in the table (see paragraph 5.3.8.1 of Volume III, RCC Document 118).

**TABLE 6-2. DIMENSIONS – RECORDED TAPE FORMAT**  
 14 Tracks Interlaced on 25.4 mm (1 in.) Wide Tape <sup>(1)</sup>

Parameters	Millimeters		Inches
	Maximum	Minimum	
Track Width	1.397	1.143	0.050 ±0.005
Track Spacing	1.778		0.070
<b>Head Spacing</b>			
Fixed Heads	38.075	38.125	1.500 ±0.001
Adjustable Heads	38.151	38.049	1.500 ±0.002
Edge Margin, Minimum	0.279		1.011
<b>Reference Track</b>			
Location	1.168	1.067	0.044 ±0.002
<b>Track Location</b>			
Tolerance	0.051	-0.051	±0.002
<b><u>Location of nth track</u></b>			
Track Number	Millimeters		Inches
	Maximum	Minimum	
1 (Reference)	0.000	0.000	0.000
2	1.829	1.727	0.070
3	3.607	3.505	0.140
4	5.385	5.283	0.210
5	7.163	7.061	0.280
6	8.941	8.839	0.350
7	10.719	10.617	0.420
8	12.497	12.395	0.490
9	14.275	14.173	0.560
10	16.053	15.951	0.630
11	17.831	17.729	0.700
12	19.609	19.507	0.770
13	21.387	21.285	0.840
14	23.165	23.063	0.910

**Note:** <sup>(1)</sup> Refer to Figure [6-1](#).

<b>TABLE 6-3. DIMENSIONS – RECORDED TAPE FORMAT</b> 14 Tracks In-Line on 25.4 mm (1 in.) Wide Tape <sup>(1)</sup>			
<b>Parameters</b>	<b>Millimeters</b>		<b>Inches</b>
	<b>Maximum</b>	<b>Minimum</b>	
Track Width	0.660	0.610	0.25 ±0.001
Track Spacing	1.778		0.070
Head Spacing			
Edge Margin, Minimum <sup>(2)</sup>	1.118	0.044	
Reference Track			
Location	0.698	0.622	0.0260 ±0.0015
Track Location			
Tolerance	0.038	-0.038	±0.0015
<b><u>Location of nth track</u></b>			
<b>Track Number</b>	<b>Millimeters</b>		<b>Inches</b>
	<u>Maximum</u>	<u>Minimum</u>	
1 (Reference)	0.000	0.000	0.000
2	1.816	1.740	0.070
3	3.594	3.518	0.140
4	5.372	5.296	0.210
5	7.150	7.074	0.280
6	8.928	8.852	0.350
7	10.706	10.630	0.420
8	12.484	12.408	0.490
9	14.262	14.186	0.560
10	16.040	15.964	0.630
11	17.818	17.742	0.700
12	19.596	19.520	0.770
13	21.374	21.298	0.840
14	23.152	23.076	0.910

**Notes:**

<sup>(1)</sup> Refer to Figure 6-1.

<sup>(2)</sup> Track location and spacing are the same as the odd tracks of the 28-track interlaced format (see Table 6-4). Edge margin for track 1 is only 0.229 mm (0.009 in.).

**TABLE 6-4. DIMENSIONS – RECORDED TAPE FORMAT**  
 14 Tracks Interlaced on 25.4 mm (1 in.) Wide Tape <sup>(1)</sup>

Parameters	Millimeters		Inches
	Maximum	Minimum	
Track Width	0.660	0.610	0.25 ±0.001
Track Spacing	0.889		0.035
Head Spacing			
Fixed Heads	38.125	38.075	1.500 ±0.001
Adjustable Heads	38.151	38.049	1.500 ±0.002
Edge Margin, Minimum <sup>(2)</sup>	0.229		1.009
Reference Track			
Location	0.699	0.622	0.0260 ±0.0015
Track Location			
Tolerance	0.038	-0.038	±0.0015
<b>Location of nth track</b>			
Track Number	Millimeters		Inches
	Maximum	Minimum	
1 (Reference)	0.000	0.000	0.000
2	0.927	0.851	0.035
3	1.816	1.740	0.170
4	2.705	2.629	0.105
5	3.594	3.518	0.140
6	4.483	4.407	0.175
7	5.372	5.296	0.210
8	6.261	6.185	0.245
9	7.150	7.074	0.280
10	8.039	7.963	0.315
11	8.928	8.852	0.350
12	9.817	9.741	0.385
13	10.706	10.630	0.420
14	11.595	11.519	0.455
15	12.484	12.408	0.490
16	13.373	13.297	0.525
17	14.262	14.186	0.560
18	15.151	15.075	0.595
19	16.040	15.964	0.630
20	16.929	16.853	0.665
21	17.818	17.742	0.700
22	18.707	18.631	0.735
23	19.596	19.520	0.770
24	20.485	20.409	0.805
25	21.374	21.298	0.840
26	22.263	22.187	0.875
27	23.152	23.076	0.910
28	24.041	23.965	0.945

**Notes:**

<sup>(1)</sup> Refer to Figure 6-1.

<sup>(2)</sup> Track location and spacing are the same as the odd tracks of the 28-track interlaced format (see Table 6-4). Edge margin for track 1 is only 0.229 mm (0.009 in.).

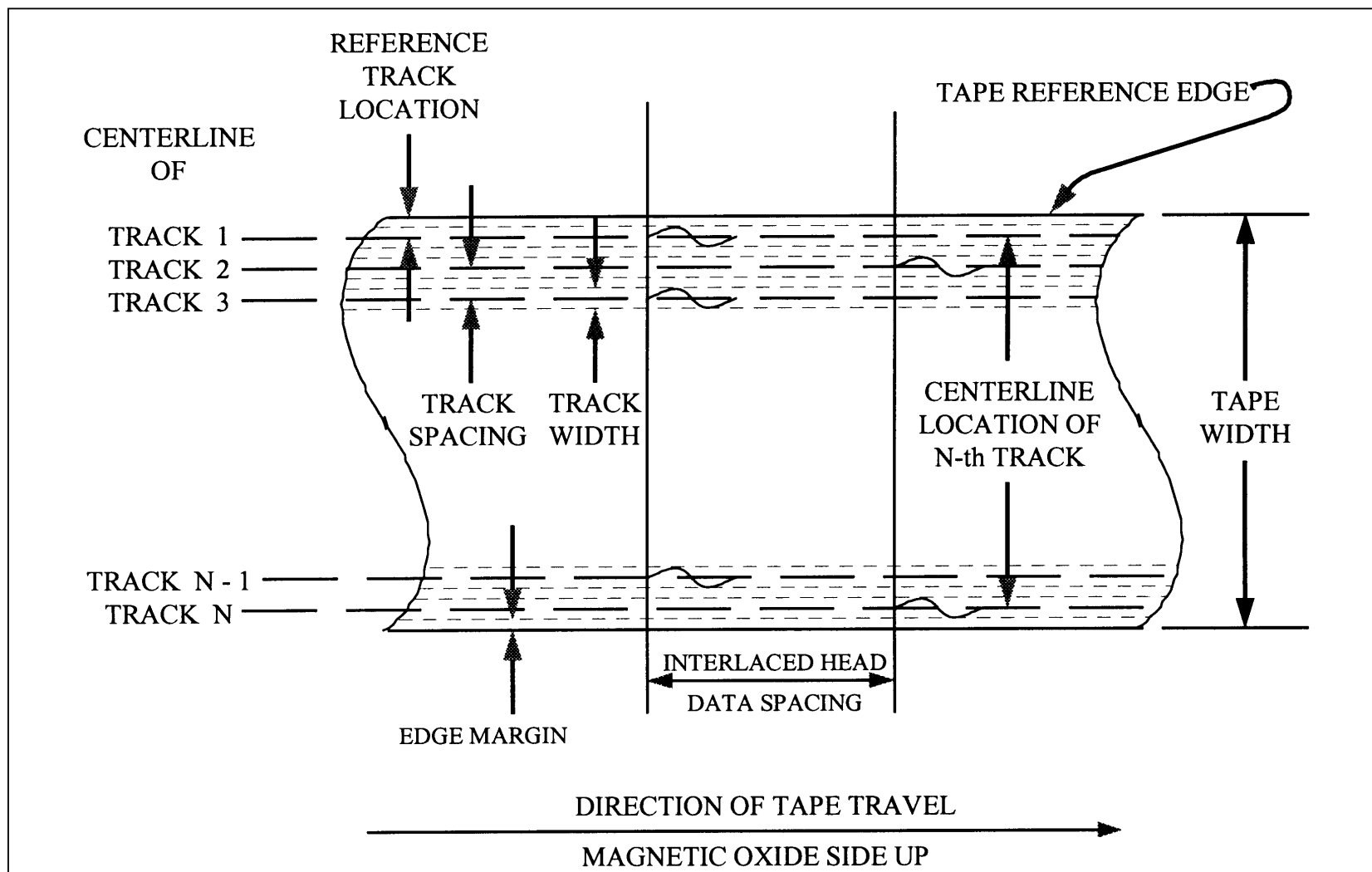

Figure 6-1. Recorded tape format.

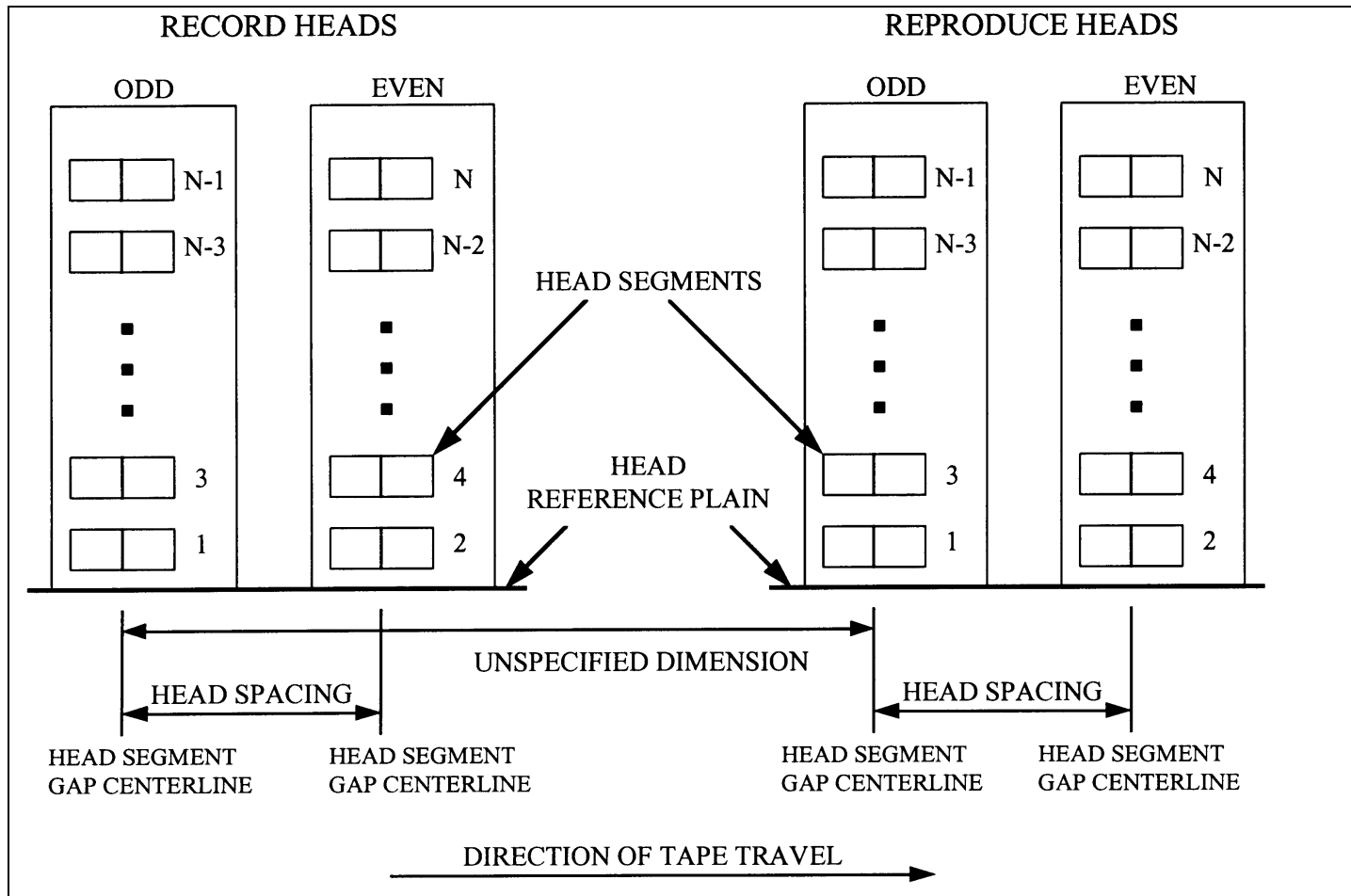

Figure 6-2. Record and reproduce head and head segment identification and location (N-track interlaced system).

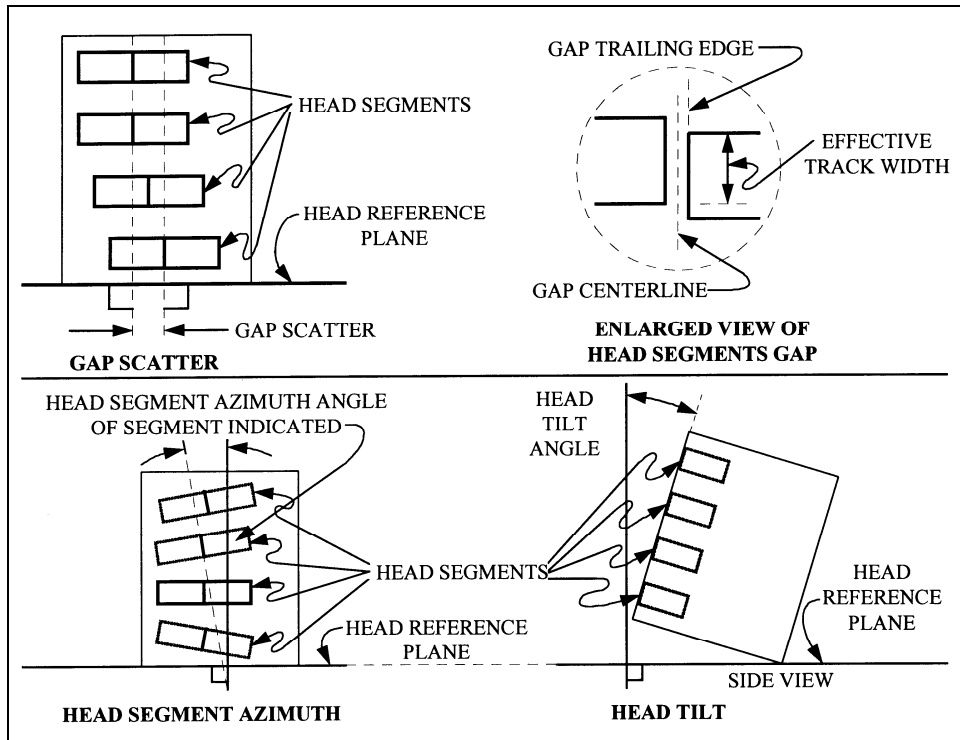

Figure 6-3. Head and head segment mechanical parameters.

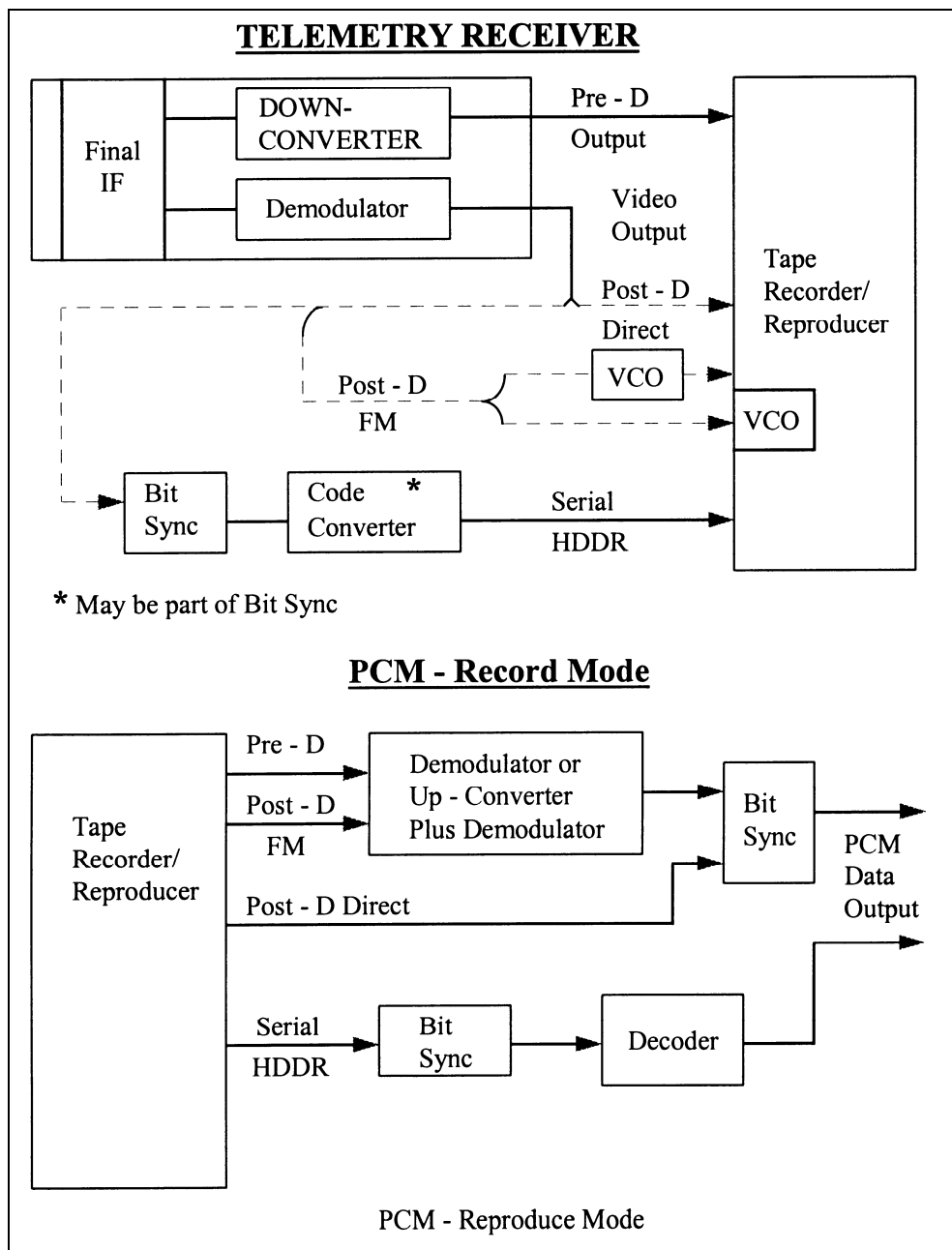

Figure 6-4. PCM record and reproduce configuration.



6.4.2 Track Numbering. The tracks on a tape are numbered consecutively from track 1 through track n with track 1 located nearest the tape reference edge as shown in Figure [6-1](#).

6.4.3 Data Spacing. For interlaced formats, the spacing on tape between simultaneous events on odd and even tracks is nominally 38.1 mm (1.5 in.) (see paragraph 6.4.4.1).

6.4.4 Head Placement. The standard technique for wide band and 28-track double density is to interlace the heads, both the record and the reproduce, and to provide alternate tracks in separate heads. Thus, to record on all tracks of a standard width tape, two interlaced record heads are used. To reproduce all tracks of a standard width tape, two interlaced reproduce heads are used. For 14-track double density, the standard technique uses one in-line record head and one in-line reproduce head.

6.4.4.1 Head Placement, Interlaced. Two heads comprise the record-head pair or the reproduce-head pair. Mounting of either head pair is done in such a manner that the center lines drawn through the head gaps are parallel and spaced 38.10 mm  $\pm 0.05$  (1.500 in.  $\pm 0.002$ ) apart, as shown in Tables [6-2](#) and [6-4](#), for systems that include head azimuth adjustment. The dimension between gap centerlines includes the maximum azimuth adjustment required to meet system performance requirements. For systems with fixed heads, that is, heads without an azimuth adjustment, the spacing between gap centerlines shall be 38.10 mm  $\pm 0.03$  (1.500 in.  $\pm 0.001$ ) (see Figure [6-2](#)).

6.4.4.2 Head Identification and Location. A head segment is numbered to correspond to the track number that segment records or reproduces. Tracks 1, 3, 5, . . . are referred to as the "odd" head segments. Tracks 2, 4, 6, . . . are referred to as the even head segments. For interlaced heads, the head containing the odd numbered segments (odd head) is the first head in a pair of heads (record or reproduce) over which an element of tape passes when moving in the forward record or reproduce direction (see Figure [6-2](#)).

6.4.4.3 In-Line Head Placement. An in-line head shall occupy the position of head number 1 in an interlaced system.

6.4.4.4 Head Segment Location. Any head segment within a head shall be located within  $\pm 0.05$  mm ( $\pm 0.002$  in.) of the nominal (dimension from table without tolerances) position required to match the track location as shown in Figure [6-1](#) and Tables [6-2](#) through [6-4](#).

## **6.5 Head and Head Segment Mechanical Parameters**

The following subparagraphs describe the mechanical parameters of the head and head segments.

6.5.1 Gap Scatter. Gap scatter shall be 0.005 mm (0.0002 in.) or less for 25.4 mm (1 in.) tape (see Figure [6-3](#) and subparagraph 4.1, [Appendix D](#)).

6.5.2 Head Segment Gap Azimuth Alignment. The head segment gap azimuth shall be perpendicular to the head reference plane to within  $\pm 0.29$  mrad ( $\pm 1$  minute of arc).

6.5.3 Head Tilt. The plane tangent to the front surface of the head at the center line of the head segment gaps shall be perpendicular to the head reference plane within  $\pm 0.29$  mrad ( $\pm 1$  minute of arc) for wide band and double density recorders (see Figure [6-3](#)).

6.5.4 Record-Head Segment Gap Parameters. The parameters for the length and azimuth alignment are described in the following subparagraphs.

6.5.4.1 Record-Head Segment Gap Length. The record gap length (the perpendicular dimension from the leading edge to the trailing edge of the gap) shall be  $2.16 \mu\text{m} \pm 0.5$  (85 microinch  $\pm 20$ ) for wide band recorders and  $0.89 \mu\text{m} \pm 0.12$  (35 microinch  $\pm 5$ ) for double density recorders (see Figure [6-3](#) and paragraph 6.0, [Appendix D](#)).

6.5.4.2 Record-Head Stack Gap Azimuth Alignment. The record-head stack azimuth shall be perpendicular to the head reference surface to within  $\pm 0.29$  mrad ( $\pm 1$  minute of arc). See paragraph 1.2, Volume III, RCC Document 118 for suggested test procedure.

6.5.4.3 Reproduce-Head Segment Gap Azimuth Alignment. The reproduce-head segment azimuth alignment shall match that of the record-head segment as indicated by reproducing an UBE frequency signal on a selected track and setting the reproduce head azimuth for the maximum output. At this azimuth setting, the output of any other track in the reproduce head shall be within 2 dB of the output at its own optimum azimuth setting (see paragraph 1.3, Volume III, RCC Document 118).

## 6.6 Head Polarity

See Chapter 1, Volume III, RCC Document 118 and subparagraph 4.2, Appendix D of this document for additional information.

6.6.1 Record-Head Segment. Each record-head winding shall be connected to its respective amplifier in such a manner that a positive going pulse referenced to system ground at the record amplifier input will result in the generation of a specific magnetic pattern on a segment of tape passing the record head in the normal direction of tape motion. The resulting magnetic pattern shall consist of a polarity sequence of south-north-north-south.

6.6.2 Reproduce-Head Segment. Each reproduce-head segment winding shall be connected to its respective amplifier in such a manner that an area of a tape track exhibiting a south-north-north-south magnetic pattern will produce a positive going pulse with respect to system ground at the output of the reproducer amplifier.

## 6.7 Magnetic Tape and Reel Characteristics

Magnetic tape and reel characteristics are specified in Chapter 7. It is recommended that all recorder and reproducer systems at a particular range be calibrated for operational use against a reference tape of the type used by the range for each bandwidth class of recorder and reproducer system. Additional supplementary procurement specifications may be required to meet a particular operational requirement of the ranges.

6.7.1 Tape Width. The standard nominal tape width is 25.4 mm (1 in.) (see Table 7-1, Tape Dimensions).

6.7.2 Tape Guiding. The tape guidance system restricts the tape angular motion to  $\pm 0.15$  mrad ( $\pm 30$  seconds of arc) as measured by the interchannel time displacement error (ITDE) of outer tracks on the same head stack. Make sure the guidance system does not damage the tape.

## 6.8 Direct Record and Reproduce Systems

Direct recording is a method of recording information signals on magnetic tape using high-frequency ac bias recording (see paragraph 6.2, Definitions). Two classes of systems, wide band and double density, are included in these standards (see Table 6-1).

6.8.1 Direct Record Parameters. The following subparagraphs describe the direct record parameters.

6.8.1.1 The input impedance for wide band and double density recorders shall be 75 ohms nominal across the specified band.

6.8.1.2 Input gain adjustment shall be provided to permit sine-wave signals of 0.35 to 3.5 V rms to be adjusted to produce standard record level.

6.8.1.3 Ideally, the recorded flux level on tape versus frequency should be constant. To approach this ideal, the record amplifier transfer characteristic is basically a constant current versus frequency with a superimposed compensation characteristic to correct only for loss of recording efficiency with frequency. Results of the test described in paragraph 1.8 Volume III, RCC Document 118, with the output amplitude at the 2 percent upper band edge (UBE) frequency used as the 0 dB reference, shall be no greater than the following:

<u>Percent of UBE Frequency</u>	<u>dB Difference</u>
10	0.5
50	1.0
80	1.6
100	2.0

6.8.1.4 Record bias setting information is contained in Table [6-1](#). The bias frequency shall be greater than 3.5 times the highest direct record frequency for which the recorder and reproducer system is designed (see Appendix D).

6.8.2 Standard Record Level. The standard record level for direct record systems is the input level of the record level set frequency, which produces an output signal containing one percent third harmonic distortion. The conditions necessary to establish the standard record level include appropriate selection of the sinusoidal reference frequency (record level set frequency) as indicated in Table [6-1](#) and proper reproduce amplifier termination as defined in Figure 1-10 Volume III, RCC Document 118. A one percent third harmonic distortion content is achieved when the level of the third harmonic of the record level set frequency is 40 dB  $\pm$ 1 below the level of a sinusoidal signal of 30 percent of UBE frequency which is recorded at the standard record level (see paragraph 5.0, [Appendix D](#) for information regarding standard test and operating practices).

6.8.3 Reproduce Parameters. The following subparagraphs describe the reproduce parameters.

6.8.3.1 For wide band and double density recorders, the output impedance shall be 75 ohms nominal across the specified passband.

6.8.3.2 When reproducing a signal at the record level set frequency (recorded at the standard record level), the output level shall be a minimum of 1 V rms with a third harmonic distortion of 1 percent and a maximum second harmonic distortion of 0.5 percent when measured across a resistive load of 75 ohms. Lack of proper output termination will not cause the reproduce amplifier to oscillate.

6.8.4 Tape Speed and Flutter Compensation. The average or long-term tape speed must be the same during record and reproduce to avoid frequency offsets, which may result in erroneous data. To minimize this problem, a reference signal may be applied to the tape during record and the signal used to servo-control the tape speed upon reproduce. However, because servo-control systems have limited correction capabilities and to minimize the amount of equipment required at the ranges, tape speeds and servo-control signals shall conform to the following standards.

6.8.4.1 The effective tape speed throughout the reel or any portion of the reel (in absence of tape-derived servo-speed control) shall be within  $\pm$ 0.2 percent of the standard speed as measured by the procedures described in Chapter 1, Volume III, RCC Document 118.

6.8.4.2 Sinusoidal or square wave speed-control signals are recorded on the tape for the purpose of servo-control of tape speed during playback. The operating level for speed-control signals shall be 10 dB  $\pm$ 5 below standard record level when mixed with other signals or standard record level when recorded on a separate track.

6.8.4.3 The constant-amplitude speed-control signal shall be used on a separate track for optimum servo-speed correction. The speed-control signal may be mixed with other signals if recording requirements so demand and system performance permits. Mixing of the speed-control signal with certain types of signals may degrade system performance for tapes which are to be reproduced on tape transports with low time-base error capstan drive systems

(refer to manufacturer). Table [6-5](#) lists speed-control signal frequencies. The speed-control signal may also be used as a flutter correction signal.

6.8.4.4 Signals to be used for discriminator flutter correction systems are listed in Tables [3-3](#) and [6-5](#). See subparagraph [6.8.4.3](#) and Table 3-3 for restrictions on use of flutter correction signals.

## **6.9 Timing, Predetection, and Tape Signature Recording**

Described in the following subparagraphs are timing signal, predetection, and tape signature recording.

6.9.1 Timing Signal Recording. Modulated-carrier, time-code signals (IRIG A, IRIG B and IRIG G) are widely used and other formats are available. When recording IRIG B time-code signals, care must be taken to ensure that low-frequency response to 100 Hz is provided. The direct record, low frequency cutoff of most wide band recorders is 400 to 800 Hz. For these systems, IRIG B time code signals should be recorded on an FM track or on an FM subcarrier. The widest bandwidth subcarrier available should be employed to minimize time delay<sup>13</sup>. For double density systems, all time code signals should be recorded on an FM track or an FM subcarrier.

6.9.2 Predetection Recording. Predetection signals have been translated in frequency but not demodulated. These signals will be recorded by direct (high frequency bias) recording. Parameters for these signals are in Table [6-6](#).

6.9.3 Tape Signature Recording. For data processing using wide band and double-density recorders and reproducers, a tape signature recorded before or after the data, or both before and after the data, provides a method of adjusting the reproducer head azimuth and reproduce equalization. A means is also provided for verifying the proper operation of equipment such as playback receivers and bit synchronizers used to retrieve the recorded data.

---

<sup>13</sup> Timing code formats are found in IRIG standard 200-98, IRIG Serial Time Formats and IRIG standard 205-87, Parallel Binary and Parallel Binary Coded Decimal Time Code Formats.

**TABLE 6-5. CONSTANT-AMPLITUDE SPEED-CONTROL SIGNALS<sup>(1)</sup>**

Tape Speed		Frequency <sup>(2)</sup>			
(mm/s)	(in./s)	(kHz)			
6096	(240 )	400	±0.01%	800	±0.01%
3048	(120 )	200	±0.01%	400	±0.01%
1524	( 60 )	100	±0.01%	200	±0.01%
762	( 30 )	50	±0.01%	100	±0.01%
381	( 15 )	25	±0.01%	50	±0.01%
190.5	( 7-1/2)	12.5	±0.01%	25	±0.01%
95.5	( 3-3/4)	6.5	±0.01%	12.5	±0.01%
47.6	( 1-7/8)	3.125	±0.01%	6.25	±0.01%

**Notes:**

- (1) May also serve as discriminator flutter-correction reference signal (see Table 3-3).
- (2) Either set of speed-control signals may be used primarily with wideband systems, but only the higher set of frequencies is recommended for double density systems. When interchanging tapes, care should be taken to ensure that the recorded speed-control signal is compatible with the reproduce system's speed-control electronics.



Caution should be used when multiplexing other signals with the speed-control signal. In the vicinity of the frequency of the speed-control signal (fsc ±10 percent), the level of individual extraneous signals including spurious, harmonics, and noise must be 40 dB or more below the level of the speed-control signal. A better procedure is to leave one octave on either side of the speed-control signal free of other signals.

**TABLE 6-6. PREDETECTION CARRIER PARAMETERS**

Tape Speed				Predetection Carrier Center Frequency <sup>(1,2)</sup>	
Wide Band		Double Density		A	<u>B</u>
(mm/s)	(in./s)	mm/s	(in./s)	(kHz)	(kHz)
6096	(240)	3048.0	(120)	1800	2400
3048	(120)	1524.0	(60)	900	1200
1524	( 60)	762.0	( 30)	450.0	600
762	( 30)	381.0	( 15)	225.0	300
381	( 15)	109.5	( 7.5)	112.5	150

**Notes:**

- <sup>(1)</sup>The predetection record/playback passband is the carrier center frequency  $\pm 66.7$  percent.
- <sup>(2)</sup> Use center frequencies in column B when data bandwidth exceeds the capabilities of those in column A.

A pulse code modulation (PCM) signature is recommended where primarily PCM data is recorded. A swept-frequency or white-noise signature may be used for other data such as frequency division multiplexing (FDM) or wide band FM. The procedures for recording and using these signatures are given in paragraph 7.0, [Appendix D](#). A recommended preamble/postamble signal for recorder/reproducer alignment is included in paragraph [6.12](#).

**6.10 FM Record Systems**

For these FM record systems, the input signal modulates a voltage- controlled oscillator, and the output is delivered to the recording head. High frequency bias may be used but is not required. These standards shall apply.

- 6.10.1 Tape and Reel Characteristics. Paragraph [7.1](#) and all related subparagraphs shall apply.
- 6.10.2 Tape Speeds and Corresponding FM Carrier Frequencies. See Table [6-7](#)
- 6.10.3 FM Record/Reproduce Parameters. See Table [6-7](#) and Figure [6-7](#), ADARIO block format.

**TABLE 6-7. WIDE BAND AND DOUBLE DENSITY FM RECORD PARAMETERS**

	Tape Speed	Carrier Center Frequency	Carrier Deviation Limits <sup>(1)</sup>		Modulation Frequency	Response Band Limits
			Plus Deviation	Minus Deviation		
	(mm/s) (in/s)		(kHz)	(kHz)	(kHz)	(dB <sup>(2)</sup> )
	Group I					
	47.6 (1-7/8)	6.750	9.450	4.050	dc to 1.250	±1
	95.2 (3-3/4)	13.500	18.900	8.100	dc to 2.500	±1
	190.5 (7-1/2)	27.000	37.800	16.200	dc to 5.000	±1
	381.0 (15 )	54.000	75.600	32.400	dc to 10.000	±1
	762.0 (30 )	108.000	151.200	64.800	dc to 20.000	±1
	1524.0 (60 )	216.000	302.400	129.600	dc to 40.000	±1
	3048.0 (120 )	432.000	604.800	259.200	dc to 80.000	±1
Double Density	Group II					
	47.6 (1-7/8)	14.062	18.281	9.844	dc to 7.810	±1, -3
	95.2 (3-3/4)	28.125	36.562	19.688	dc to 15.620	±1, -3
95.2 (3-3/4)	190.5 (7-1/2)	56.250	73.125	39.375	dc to 31.250	±1, -3
190.5 (7-1/2)	381.0 (15 )	112.500	146.250	78.750	dc to 62.500	±1, -3
381.0 (15 )	62.0 (30 )	225.000	292.500	157.500	dc to 125.000	±1, -3
762.0 (30 )	1524.0 (60 )	450.000	585.000	315.000	dc to 250.000	±1, -3
1524.0 (60 )	3048.0 (120 )	900.000	1170.000	630.000	dc to 500.000	±1, -3
3048.0 (120 )	6096.0 (240 )	1800.000	2340.000	1260.000	dc to 1000.000	±1, -3

**Notes:**

- (1) Input voltage levels per subparagraph 6.4.1.
- (2) Frequency response referred to 1-kHz output for FM channels 13.5 kHz and above, and 100 Hz for channels below 13.5 kHz.



6.10.4 Speed Control and Compensation. Subparagraph [6.8.4](#) shall apply. Note that a separate track is always required for speed control and flutter compensation signals with a single-carrier FM system.

6.10.5 FM Record Parameters. For FM record systems, an input voltage of 1 to 10V peak-to-peak shall be adjustable to produce full frequency deviation.

6.10.5.1 Deviation Direction. Increasing positive voltage gives increasing frequency. Predetection recorded tapes may be recorded with reverse deviation direction because of the frequency translation techniques employed.

6.10.6 FM Reproduce Systems. Output levels are for signals recorded at full deviation. In wide band and double density FM systems, the output is 2 V peak-to-peak minimum across a load impedance of 75 ohms  $\pm$ 10 percent. Increasing input frequency gives a positive going output voltage.

## **6.11 PCM Recording**

The PCM signals may be successfully recorded using several different methods. Methods included in these standards are predetection recording, post-detection recording, and serial high-density digital recording (HDDR). Parallel HDDR methods are not included.

6.11.1 Predetection PCM Recording. This method employs direct recording of the signal obtained by heterodyning the receiver IF signal to one of the center frequencies listed in Table [6-6](#) without demodulating the serial PCM signal (see Figure [6-4](#)). The maximum recommended bit rate for predetection recording of NRZ data is equal to the predetection carrier frequency, for example, 900 kb/s for a 900 kHz predetection carrier. The maximum recommended bit rate for predetection recording of bi-phase (Bi $\phi$ ) data is equal to one-half the predetection carrier frequency. For bit rates greater than one-half the maximum recommended rates, the preferred method of detection is to convert the signal to a higher frequency before demodulation.

6.11.2 Post-Detection PCM Recording. The serial PCM signal (plus noise) at the video output of the receiver demodulator is recorded by direct or wide band FM recording methods without first converting the PCM signal to bi-level form (see Figure [6-4](#)). Table 6-8 lists maximum bit rates versus tape speed for these recording methods. The minimum recommended reproduce bit rates are 10 kb/s for post-detection direct Bi $\phi$  and 10 bits per second for post-detection FM (see paragraph [4.2.2.3](#)).

**TABLE 6-8. MAXIMUM RECOMMENDED BIT RATES, POST-DETECTION RECORDING<sup>(1)</sup>**

Tape Speed				Post-D Direct	Post-FM	
Wide Band		Double Density			Biφ (kb/s)	NRZ (kb/s)
(mm/s)	(in./s)	(mm/s)	(in./s)	Biφ (kb/s)		
6096.0	(240 )	3048.0	(120 )	1800	900	1800
3048.0	(120 )	1524.0	( 60 )	900	450	900
1524.0	( 60 )	762.0	( 30 )	450.0	225	450
762.0	( 30 )	381.0	( 15 )	225.0	112	225
381.0	( 15 )	109.5	( 7-1/2)	112.5	56	112
190.0	( 7-1/2)	95.2	( 3-3/4)	56	28	56
95.2	( 3-3/4)	---		28	14	28
47.6	( 1-7/8)	---		14	7	14

**Note:**

<sup>(1)</sup> Direct recording of NRZ signals is NOT recommended unless the signal format is carefully designed to eliminate low-frequency components for any data expected.

6.11.3 Serial High-Density Digital Recording. Serial HDDR is a method of recording PCM data on a magnetic tape which involves applying the data to one track of the recorder as a bi-level signal.

6.11.4 This paragraph deals with standards for direct recording of PCM telemetry data using a wide band analog instrumentation recorder or reproducer system. Direct recording is described in paragraph 6.8. The recommended PCM codes, maximum bit rates, record and reproduce parameters, and the magnetic tape requirements are also described.

PCM Codes. The recommended codes for serial high-density PCM recording are bi-phase level (Biφ-L) and randomized non return to zero-level (RNRZ-L). The maximum recommended bit packing densities (for wide band recording) are 590 b/mm (15 kb/in.) for Biφ-L and 980 b/mm (25 kb/in.) for RNRZ-L. Refer to Table 6-9 for maximum recommended bit rates versus standard tape speeds. The minimum recommended reproduce bit rates are 5 kb/s for Biφ-L and 200 kb/s for RNRZ-L. Details of the implementation are discussed in paragraph 3.0, [Appendix D](#).

TABLE 6-9. MAXIMUM RECOMMENDED BIT RATES					
Tape Speed				<u>Biφ-L</u> (kb/s)	<u>RNRZ-L</u> (kb/s)
<u>Wide Band</u>		<u>Double Density</u>			
(mm/s)	(in./s)	(mm/s)	(in./s)		
6096.0	(240 )	3048.0	( 120 )	3600	6000
3048.0	(120 )	1524.0	( 60 )	1800	3000
1524.0	( 60 )	762.0	( 30 )	900	1500
762.0	( 30 )	381.0	( 15 )	450	750
381.0	( 15 )	109.5	( 7-1/2)	225	375
190.0	( 7-1/2)	95.2	( 3-3/4)	112	187 <sup>(1)</sup>
95.2	( 3-3/4)	---		56	93 <sup>(1)</sup>
47.6	( 1-7/8)	---		28	46 <sup>(1)</sup>

**Note:**

<sup>(1)</sup> Reproducing data at bit rates less than 200 kb/s is not recommended when using RNRZ-L (see Appendix D for details).

6.11.4.2 Biφ-L Code. The Biφ-L code is recommended for direct recording under the following conditions: the bit rate of the data to be recorded does not exceed the maximum bit rates for Biφ-L (see Table 6-9), and the amount of tape required for mission recording by this method is not a severe operational constraint.

6.11.4.3 RNRZ-L Code. The RNRZ-L code is recommended for direct recording under any of the following conditions: the bit rate of the data to be recorded exceeds the maximum recommended bit rates for Biφ-L (see Table 6-9) or maximum tape recording time is needed.

6.11.4.3.1 To minimize baseline wander anomalies, RNRZ-L is NOT recommended if the reproduced bit rate is less than 200 kb/s.

6.11.4.3.2 The RNRZ-L shall be implemented using a 15-stage shift register and modulo-2 adders (see Figure 6-5). The randomized bit stream to be recorded is generated by adding (modulo-2) the input bit stream to the modulo-2 sum of the outputs of the 14th and 15th stages of the shift register. In the decoder, the randomized bit stream is the input to the shift register (see Figure 6-5).

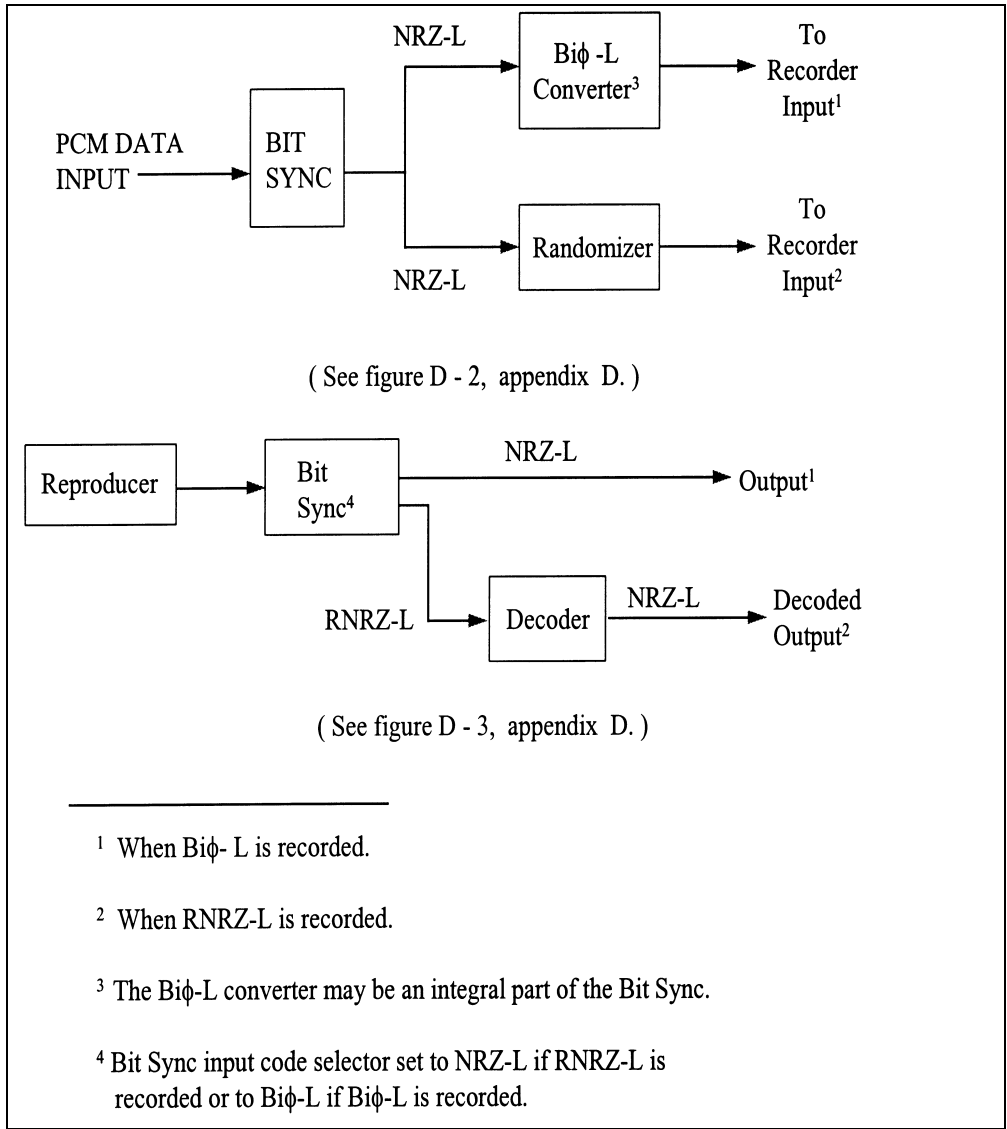

Figure 6-5. Serial high-density digital record and reproduce.

6.11.4.4 Record Parameters. The record parameters are explained in the following subparagraphs.

6.11.4.4.1 High-density PCM data shall be recorded in compliance with the direct record parameters detailed in subparagraph [6.8.1](#) including the use of an ac bias signal level which produces the required 2 dB over-bias condition.

6.11.4.4.2 The peak-to-peak level of the PCM input signal shall be equal to twice the rms value of the signal amplitude used to establish the standard record level with a tolerance of  $\pm 25$  percent (see subparagraph [6.8.2](#)).

6.11.4.4.3 The signal to be recorded must be bi-level. Bi-level signals are signals where only two levels are present. Therefore, signals containing noise must be converted to bi-level signals before they are recorded.

6.11.4.4.4 To minimize the effects of tape dropouts, serial high-density digital data should not be recorded on the edge tracks of the tape.

6.11.4.5 Reproduce Parameters. All reproduce parameters in subparagraph [6.8.3](#) shall apply.

6.11.4.5.1 PCM Signature. A PCM signature should be recorded before or after or both before and after the data to provide a method for adjusting the reproduce head azimuth and the reproducer equalizers. The data rate of the PCM signature should be the same as the rate of the data to be recorded (see paragraph [7.0](#), Appendix D for tape signature recording).

6.11.4.5.2 Phase Equalizer. Correct phase equalization is very important to the reconstruction of the serial high-density digital data. Adjustable phase equalizers are desirable but not mandatory.

6.11.4.6 Magnetic Tape. High-density digital (HDD) magnetic tapes are recommended; however, wide band instrumentation tapes can be used on recorder and reproducer systems with 1.27 mm (0.050 in.) track widths (see Chapter 7).

6.11.4.7 Tape Copying. The following practices are recommended when making copies of original data tapes.

6.11.4.7.1 Convert data reproduced from the original tape to a bi-level signal prior to recording a copy.

6.11.4.7.2 Align reproduce head azimuth to original tape.

6.11.4.7.3 Adjust reproducer equalizers correctly.

6.11.4.7.4 Prior to recording the copy, use the recorded PCM signature to optimize the quality of the reproduced data.

6.11.4.8 PCM Bit Synchronizer. The PCM bit synchronizer should contain circuitry to reestablish the baseline reference PCM signal (a dc restorer circuit). This circuit is essential

when reproducing RNRZ-L at reproduced bit rates less than 1 Mb/s. The PCM bit synchronizer loop bandwidth should be selected for optimum performance between 0.1 and 3 percent of the bit rate.



If an appropriate PCM bit synchronizer is not available, the tape can be copied directly; however, the SNR will be decreased.

## 6.12 Preamble Recording for Automatic or Manual Recorder Alignment

A preamble (or postamble) may be recorded on the same tape as the data signal with known frequency and amplitude elements which will allow automatic or manual alignment of the signal electronics to optimize the performance of the playback system. Reproduce azimuth, equalization, and FM demodulator sensitivity may be adjusted at all available tape speeds. The preamble may be used for manual adjustment of any instrumentation magnetic tape recorder/reproducer (wide band and double density). Automatic adjustment requires a recorder/reproducer specifically designed with the capability to automatically adjust one or more of the following: reproduce-head azimuth, amplitude equalization, phase equalization, and FM demodulator sensitivity. The signal source may be internal to the recorder or may be externally generated.

6.12.1 Alignment, Direct Electronics. Direct electronics shall use a 1/11 band edge square wave for both manual and automatic alignment as given in [Appendix D](#).

6.12.2 Alignment, FM Electronics. The FM electronics shall use a 1/11 band edge square wave and  $\pm 1.414$  Vdc or 0.05 Hz square wave for both manual and automatic alignment as given in Appendix D.

## 6.13 19-mm Digital Cassette Helical Scan Recording Standards

These standards are for single-channel high-bit rate helical scan digital recorders using 19 mm tape cassettes. Bit rates of less than 10 megabits per second to 256 megabits per second or greater may be recorded and reproduced by equipment conforming to these standards. Interchange parties must, however, determine the availability at a particular site of the equipment required to meet particular data recording requirements. Compatibility between the recording device and the expected playback equipment must also be considered.

6.13.1 **Track Format.** The format recorded and reproduced by these systems shall be as specified in American National Standard For Information Systems 19-mm Type ID-1 Recorded Instrumentation Digital Tape Format, ANSI INCITS 175-1999.<sup>14</sup> Helical tracks employ azimuth recording wherein the head gap angle with respect to the recorded track center line is  $90^\circ + 15^\circ$  for one scan and  $90^\circ - 15^\circ$  for the adjacent scan. Figure 6-6 and Table 6-10 show details of the helical tracks and auxiliary longitudinal tracks for control, timing, and annotation in the ID-1 format.

6.13.2 **Tape and Cassettes.** Magnetic tape and 19-mm cassettes are specified in Chapter 7. The magnetic tape shall meet the requirements for 850 oersted class (68 000 A/M). A tape base thickness of 16  $\mu\text{m}$  is normally employed. The recorder/reproducers shall be capable of using 19-mm cassettes that conform to the physical dimensions of medium and large cassettes as shown in Table 6-11. Table 6-11 shows tape capacities and indicates the amount of time available for recording, assuming a data input rate of 240 megabits per second.

6.13.3 **Recorder/Reproducer Input and Output.** Data input and clock are required. The data input shall be in an 8-bit parallel, byte serial format, and the clock signal will be at the required byte rate. Data output will also be in 8-bit parallel format.

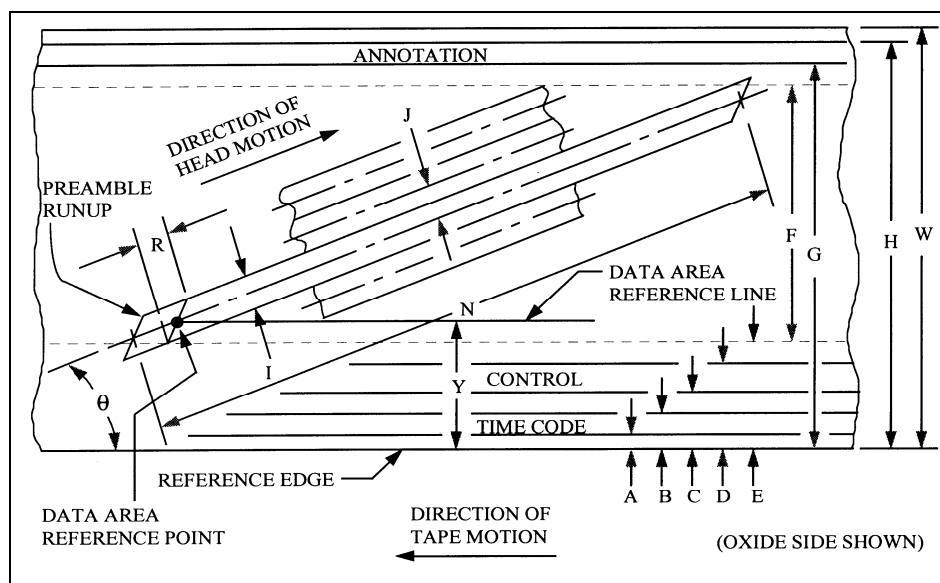

Figure 6-6. Location and dimensions of recorded tracks.

<sup>14</sup> Formerly ANSI -1990. Available from American National Standards Institute ([webstore.ansi.org](http://webstore.ansi.org)).

<b>TABLE 6-10. RECORD LOCATION AND DIMENSIONS</b>		
<b>Dimensions</b>		<b>Nominals</b>
A	TIME-CODE TRACK LOWER EDGE	0.2 mm
B	TIME-CODE TRACK UPPER EDGE	0.7 mm
C	CONTROL TRACK LOWER EDGE	1.0 mm
D	CONTROL TRACK UPPER EDGE	1.5 mm
E	DATA-AREA LOWER EDGE	1.8 mm
F	DATA-AREA WIDTH	16 mm
G	ANNOTATION TRACK LOWER EDGE	18.1 mm
H	ANNOTATION TRACK UPPER EDGE	18.8 mm
I	HELICAL TRACK WIDTH	0.045 mm
J	TRACK PITCH, BASIC	0.045 mm
N	HELICAL TRACK TOTAL LENGTH	170 mm
P	ANNOTATION/TIME-CODE HEAD LOCATION	118.7 mm
R	SECTOR RECORDING TOLERANCE	±0.1 mm
T	CONTROL TRACK SYNC TOLERANCE	±0.1 mm
P	TRACK ANGLE, ARC-SINE (16/170)	5.4005°
W	TAPE WIDTH	19.01 mm

<b>TABLE 6-11. TAPE LENGTH AND NOMINAL PLAY RECORD/ REPRODUCE TIME AT 240 MEGABITS/SECOND USER DATA RATE</b>			
<b>Cassette</b>	<b>Tape Thickness (micrometers)</b>	<b>Tape Length (meters)</b>	<b>Play Time (minutes)</b>
Medium	16	587	24
Large	16	1311	55
<b>CASSETTE DIMENSIONS NOMINAL</b>			
<b>Cassette</b>	<b>Length</b>	<b>Width</b>	<b>Thickness</b>
Medium	254 mm	150 mm	33 mm
Large	366 mm	206 mm	33 mm



#### 6.14 Multiplex/Demultiplex (MUX/DEMUX) Standard for Multiple Data Channel Recording on 19-MM Digital Cassette Helical Scan Recorder/Reproducer Systems

For recording and reproducing multiple channels on 19-mm Digital Cassette Helical Scan Recorders, the ADARIO multiplex/demultiplex format is recommended. The ADARIO (Analog/Digital/ Adaptable/Recorder Input/Output) format was developed for the Department of Defense, Fort Meade, Maryland. The format is government-owned and may, therefore, be used in equipment provided for government activities. Following are some of the ADARIO features:

- requires less than 3 percent overhead to be added to user data;
- accommodates multiple channel record/playback with each channel completely autonomous in sample rate and sample width;
- stores all the necessary parameters for channel data reconstruction for either real-time playback, time-scaled playback, or computer processing;
- preserves phase coherence between data channels;
- provides channel source and timing information; and
- accommodates  $2^{24}$  (over 16 million) blocks of data, each block having 2048 24-bit words (see Figure 6-7).

The ADARIO format imposes minimum restrictions on the channel signals and aggregate data parameters. Specific implementations that use the ADARIO format may impose additional restrictions. ADARIO format, defined field restrictions are listed below:

Session length	Unlimited
Sequence numbered	Blk. $2^{24}$ (100 G byte max.)
Master clock	MC $2^{19}$ *250 Hz (131 MHz max.)
Block rate	BMD, MC/BMD (8 blk./sec min.) MC/2048 (64K blk./sec. max.)
Aggregate rate	MC *24 (3145 Mbps max.)
Channel quantity	Q, Ch#, $2^4$ (16 channels max.)
Bits per sample	FMT, 1,2,3,4,5,6,7,8,10,12,14,16,18,20,22,24 bits per sample
Input clock rate	MC, Rate $2^{19}$ *250 Hz (131 MHz max.)
Input bit rate	2035 *24 block rate (3125 Mbps max.)
Analog bandwidth	MC/2.5 (52.4 MHz max.)
Analog attenuation	Atten, $2^5$ (-15 dB, +16 dB)
Analog coupling	DCAC (dc or ac)
Time correlation	1/MC (7.6 ns max. resolution) TD/MC $2^{16}$ (65, 536*MC max. range)
Channel card types	CHT, $2^6$ (64 max.)

Channel input digital data can be in any format, serial or parallel, in any coding, and at any levels, TTL, ECL, that can be accommodated by the channel type card used. Channel input

analog signals can contain any form of modulation, at any nominal level, with any dynamic within the limitations (see Figure 6-8).

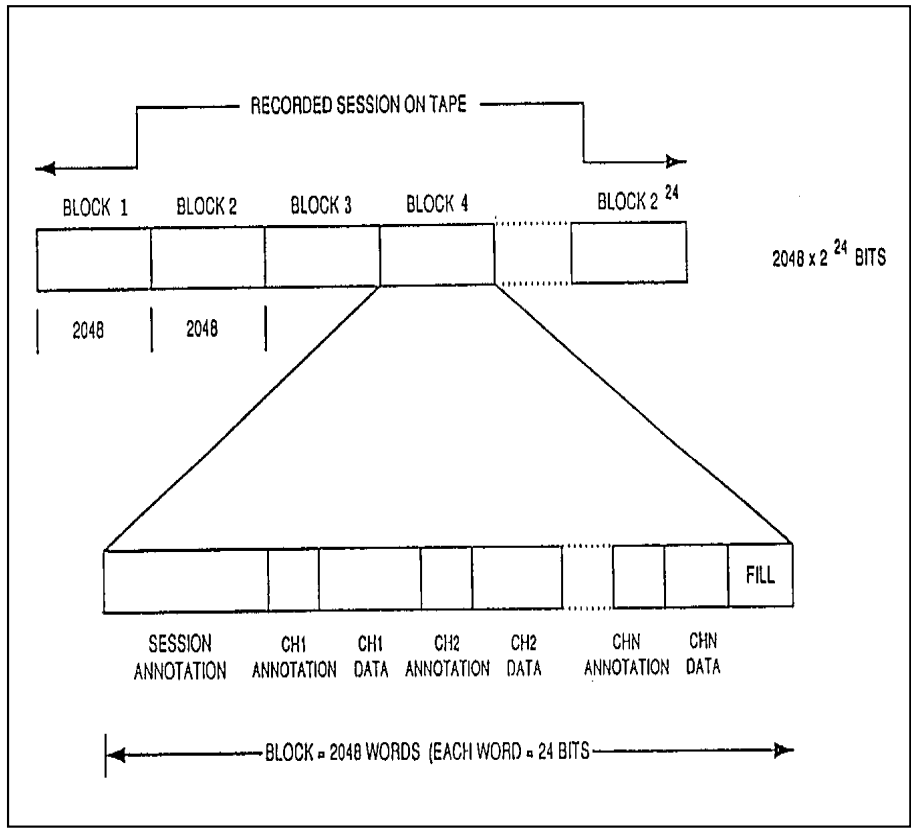

Figure 6-7. ADARIO block format.

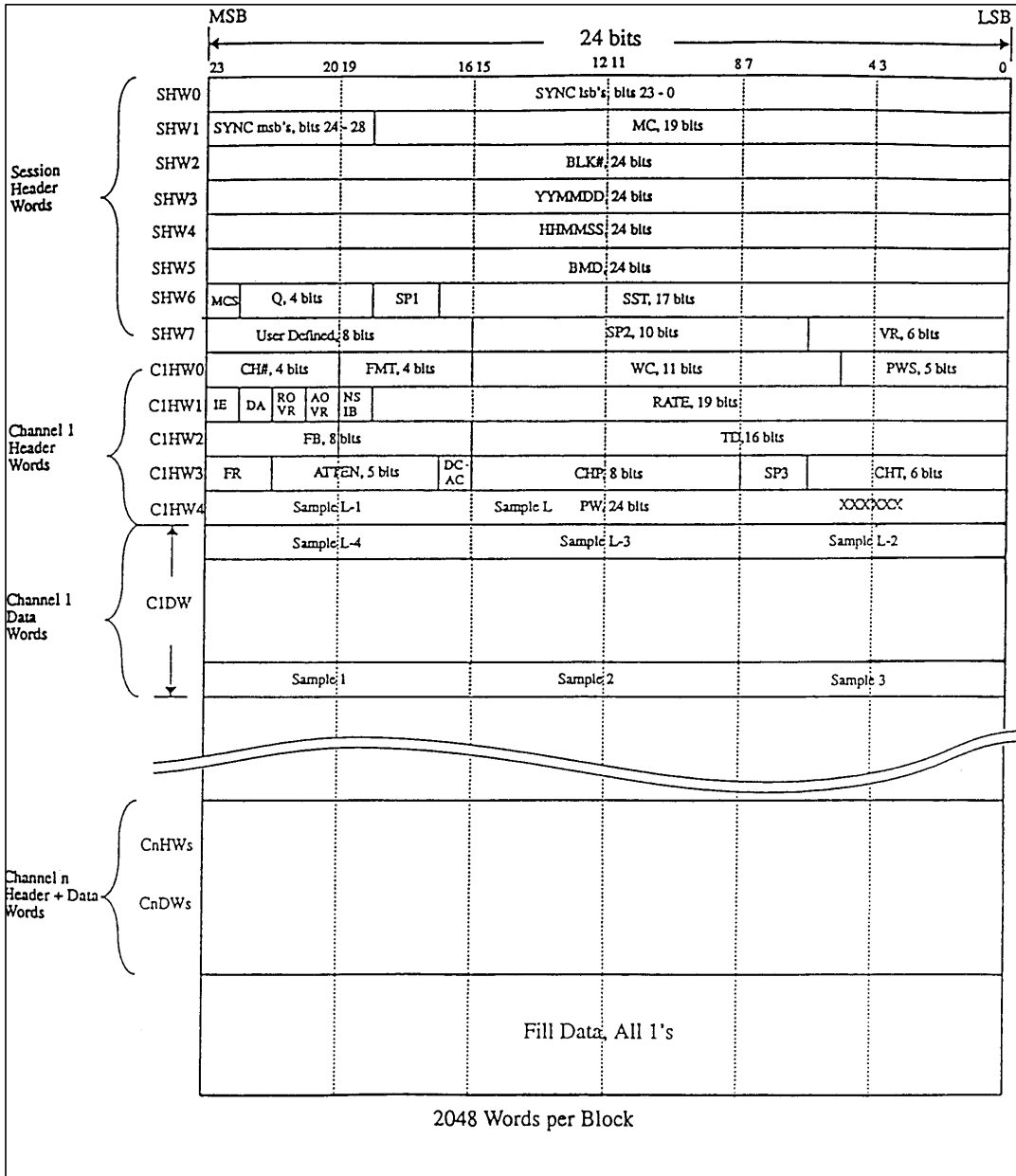

Figure 6-8. ADARIO data format.

## **6.15 Submultiplex/Demultiplex Standards for Multiple Data Channels on a Primary Digital Multiplex/Demultiplex Channel**

For combining multiple low to medium rate telemetry channels on a single primary digital channel such as the ADARIO input channel, the submultiplex (submux) format is recommended. The format was developed for test range applications where high quantity of channels must be collected in conjunction with high data rate primary channels. The submux format provides a standard for extending the ADARIO primary channel or any other primary digital channel for conveying data from up to 31 subchannels in digital aggregate data form. Each channel is totally autonomous and can be enabled/disabled at any time. Some of the features of the submux format are the following:

- accommodates analog, digital clocked and asynchronous, time and annotation text, and other application specific telemetry channels.
- requires less than 0.3 percent of overhead per channel;
- stores all necessary parameters for channel signal reconstruction in real or scaled time;
- preserves phase coherence between all channels for all rates (dc to maximum) and all types of channels; and
- accommodates variable and fixed rate primary channel of up to 256 Mbps.

6.15.1 Format Structure. General structure of the submux format is based on a constant block rate and variable block data length for each channel data block. The aggregate data stream is the sequential collection of each enabled channel data block with a three-word header. Each channel data block is the sequential collection of data samples or events within the block time period. A reserved channel (channel ID=31) provides frame synchronization and block timing and is always the first channel in the frame sequence. Individual channels can be enabled or disabled at any time within the rate limitations of the primary channel. Primary channel redundant parameter fields such as date, time, and annotation are placed in optional defined channel types, thereby, minimizing overhead caused by redundancy. All data and headers are bit packed into 16-bit words. All fields, unless specifically stated, are binary coded. Physical implementation of the format may have design restrictions as to types and quantities of channels and maximum allowable field limits.

6.15.2 Implied Parameters and Limits. Maximum aggregate rate (256 Mbps), block rate, first sample time delay measurement, and internal sample period are based on a 16-MHz clock rate divided by  $2^N$ , where N can be set from 0 to 7 defining the derived clock. Block rate is based on the derived clock divided by 20 160 which sets the limit on the total aggregate word count of all channels in a block period. The maximum block rate (793.65 blocks per second) in conjunction with the 16-bit bit count field, limits the maximum subchannel input rate to 52 Mbps. The 16-MHz clock limits the time delay resolution to 62.5 nanoseconds.

The maximum number of channels is limited by the 5-bit field and the reserved block sync channel to 31 channels numbered from 0 to 30. Channel ID of 31 is the reserved block sync channel that conveys timing information. To accommodate fixed rate primary channel, fill can be inserted after the last channel data block, prior to the next block sync channel (at the end of the frame), and must consist of all binary ones (FFFF hex word value).

Channel priority is fixed in channel number sequence with channel ID of 31 (block sync) first, followed by channel ID 0, if enabled, to channel ID 30, followed by fill (if required) to maintain fixed channel rate. Any channel can be one of eight channel types. Type 0 channels convey timing data in the 3-word header and have implied data length of 0. Type other than zero contains the bit count field that defines the length of valid data in the data block. The actual word length of the data block is the integer of  $\{(bit\ count + 15)/16\}$ . Channel type also defines the content of the fields in the header.

**6.15.3 Defined Parameters.** Each channel data block has a 3-word (16-bit) header that contains the channel ID number, channel type, and other defined and undefined fields based on the channel type code. Undefined fields are reserved for future use and should be zero filled. Each channel header also contains up to 4 status bits that indicate the condition in the current data block or the condition of the last aggregate frame.

Channel ID 31 is a special form of channel type 0. The first two words are used for synchronization and are F8C7 BF1E hex value. The block rate clock (BRC) defines the main clock binary divider and is used for time scaled signal reconstruction. Each increment time period doubles. "Fill" indicates if the primary channel requires fill for fixed data rate.

Channel ID can be any unique number from 0 to 30 and designates the physical subchannel used for acquiring the data. Channel type defines the type of data this channel conveys and is currently defined for 0 to 5.

A type 0 "time tag" channel typically processes IRIG time code data and is used to time tag the frame. The Days Hours Minutes Seconds Fractional Seconds fields are the content of IRIG time code input or channel derived and in the same BCD form as the IRIG G time code.

Type nonzero headers contain FMT field that defines the format of the sample in bits per sample, 4-bit status field that indicates any errors or warnings pertaining to the current data block, bit count field that defines the length of valid data in the data block, and time delay field that (when external clock is used) indicates the delay from block time to the first sample in the BRC defined clock periods. When the internal clock is used, as indicated by type or most significant bit (MSB) of time delay, the sample period field defines the period of the internal sample clock in the BRC defined clock periods. The internal sample clock is always an integer divisor of the block period and the first sample is coincident with the block time. In type 1 blocks, this field is used for sequential block count.

When the internal clock is used with digital serial channel, the data and clock lines are sampled at the designated rate and result in eight data and eight clock samples per data block word. Otherwise, all incoming digital data are sampled at the incoming clock and results in a

sample in the data block, with the first sample being left justified in the first word with “format” designated number of bits starting with the MSB of the sample. Samples are bit sequentially packed regardless of word boundaries. The last sample in the block period is fully packed into the current data block with the remaining portion of the word, if any, being left undefined.

6.15.4 Aggregate Format on the Primary Data Channel. Figures [6-9a](#) and [b](#) show the defined types of channel data from which the aggregate is composed. The primary data will always consist of the “frame sync” block followed by one or more unique channel blocks, followed by fill if required. The frame sync block will be generated at block rate. Aggregate data may be clocked by the primary channel or by the submux at constant or burst rate depending on the primary channel characteristics. Data format field definitions appear in [Appendix G](#), Submux Data Format Field Definitions.

6.15.5 Submux/Demux FILL Requirement. The submux produces aggregate data at the user aggregate data rate. In other words, the rate and amount of data produced on the aggregate output is directly proportional to the user specified clock and data format bits and is averaged over the frame period. This variable aggregate data rate is acceptable to variable rate primary channels or buffered variable rate recorders.

Fixed rate primary channels and fixed rate recorders require data at some fixed rate. The fixed rate is usually set to be the maximum expected user aggregate rate. When the user aggregate rate is less than the maximum, then some sort of filler is necessary to maintain the constant output rate. The format-specified fill word provides this filler and is automatically generated when the primary channel or fixed rate recorder provides clocks after the last word of the last enabled channel is clocked out within the frame period. Fill is always terminated by the Frame of Block Sync channel, indicating the presence of the next frame data.

The quantity of fill words is totally dependent on the fixed primary channel rate and the average user aggregate rate within one frame period. Minimum is zero words when user rates are at the maximum and equal to the fixed rate (minus the overhead). When user rates are at the minimum, maximum amount of fill will be generated for maintaining constant output rate.

		16 BITS																
		15	14	13	12	11	10	9	8	7	6	5	4	3	2	1	0	
GENERAL FORM	HW1	CHN ID				CHT			FMT				ST1	ST2	ST3	ST4		
	HW2																	
	HW3	I/E	TIME DELAY OR SAMPLE PERIOD															
FRAME SYNC	HW1	CHN ID = 1F				CHT = 0			SYNC 1 = F8C7 HEX (FULL WORD)									
	HW2	SYNC 2 = BF1E HEX																
	HW3	BRC		FILL										AOE	PCR	ST3	ST4	
TIME TAG	HW1	CHN ID = 0 TO 30				CHT = 0			MSB DAYS (BCD)									
	HW2	DAYS	HOURS (BCD)				MINUTES (BCD)											
	HW3	SECONDS (BCD)				FRACTIONAL SECONDS												
ANNOTATION TEXT	HW1	CHN ID = 0 TO 30				CHT = 1			FMT = 7				NC	OVR	PE	OE		
	HW2	BIT COUNT																
	HW3	BLOCK COUNT																
	DW1	MSB	1ST CHARACTER						MSB	2D CHARACTER								
	:																	
	DWn	MSB	LAST CHARACTER						UNDEFINED IF NOT LAST									
DIGITAL SERIAL EXTERNAL CLOCK	HW1	CHN ID = 0 TO 30				CHT = 2			FMT = 0				NSIB	OVR	ST3	ST4		
	HW2	BIT COUNT = L																
	HW3	I/E=0	TIME DELAY															
	DW1	DS <sub>1</sub>	DS <sub>2</sub>	DS <sub>3</sub>	DS <sub>4</sub>	DS <sub>5</sub>	DS <sub>6</sub>	DS <sub>7</sub>	DS <sub>8</sub>	DS <sub>9</sub>	DS <sub>10</sub>	DS <sub>11</sub>	DS <sub>12</sub>	DS <sub>13</sub>	DS <sub>14</sub>	DS <sub>15</sub>	DS <sub>16</sub>	
	:																	
	DWn							DS <sub>L-1</sub>	DS <sub>L</sub>	UNDEFINED IF NOT LAST								

Figure 6-9a. Submux data format.

16 BITS																		
15	14	13	12	11	10	9	8	7	6	5	4	3	2	1	0			
DIGITAL SERIAL INTERNAL CLOCK.	HW1	CHN ID = 0 TO 30				CHT = 2			FMT = 0			0	0	ST3	ST4			
	HW2	BIT COUNT = L																
	HW3	I/E=1							SAMPLE PERIOD									
	DW1	DS <sub>1</sub>	DS <sub>2</sub>	DS <sub>3</sub>	DS <sub>4</sub>	DS <sub>5</sub>	DS <sub>6</sub>	DS <sub>7</sub>	DS <sub>8</sub>	CS <sub>1</sub>	CS <sub>2</sub>	CS <sub>3</sub>	CS <sub>4</sub>	CS <sub>5</sub>	CS <sub>6</sub>	CS <sub>7</sub>	CS <sub>8</sub>	
	:																	
	DW2	DS <sub>L</sub>	DS <sub>L</sub>	DS <sub>L</sub>	DS <sub>L</sub>	DS <sub>L</sub>	DS <sub>L</sub>	DS <sub>L</sub>	DS <sub>L</sub>	CS <sub>L</sub>	CS <sub>L</sub>	CS <sub>L</sub>	CS <sub>L</sub>	CS <sub>L</sub>	CS <sub>L</sub>	CS <sub>L</sub>	CS <sub>L</sub>	
DIGITAL PARALLEL EXTERNAL CLOCK	HW1	CHN ID = 0 TO 30				CHT = 3			FMT = 0-15 (shown = 6)			NSIB	OVR	ST3	ST4			
	HW2	BIT COUNT = L																
	HW3	I/E=0	TIME DELAY															
	DW1	MSB	1 <sup>ST</sup> SAMPLE					MSB	2 <sup>ND</sup> SAMPLE					3 <sup>RD</sup> SAMPLE				
	:																	
	DW2		MSB	LAST SAMPLE				LSB=BIT L			UNDEFINED IF NOT LAST							
ANALOG WIDE BAND	HW1	CHN ID = 0 TO 30				CHT = 4			FMT = 0-15 (shown = 7)			AOR	ST2	ST3	ST3			
	HW2	BIT COUNT = L																
	HW3	I/E=1				SAMPLE PERIOD												
	DW1	MSB	1 <sup>ST</sup> SAMPLE					MSB					2 <sup>ND</sup> SAMPLE					
	:																	
	DW <sub>n</sub>	MSB	LAST SAMPLE				UNDEFINED IF NOT LAST											
ANALOG STEREO "L" & "R"	HW1	CHN ID = 0 TO 30				CHT = 5			FMT = 0-15 (shown = 7)			LAOR	RAOR	ST3	ST4			
	HW2	BIT COUNT = L																
	HW3	I/E=1	ENL	ENR		SAMPLE PERIOD												
	DW1	MSB	1 <sup>ST</sup> SAMPLE "L"					MSB					1 <sup>ST</sup> SAMPLE "R"					
	:																	
	DW <sub>n</sub>	MSB	LAST SAMPLE				UNDEFINED IF NOT LAST											
FILL	FW	FILL WORD – FFFF HEX																

Figure 6-9b. Submux data format.



## 6.16 1/2 Inch Digital Cassette (S-VHS) Helical Scan Recording Standards

These standards are for helical scan digital magnetic tape recorder/reproducers using the very large data store (VLDS) format. This standard is intended for applications where compact size is needed and bit rates do not exceed 32 or 64 megabits per second (Mbps). The VLDS is a 12.65 mm (1/2 inch) S-VHS (850 oersteds nominal ) media based tape format. This standard describes the salient features of the LDS format. To ensure crossplay compatibility between recorders of different manufacturers, refer to Metrum-Datatape document number 16829019, *M64/32HE Magnetic Tape Recorder/Reproducer Tape Format Specification*.



Metrum-Datatape is now Sypris Data Systems and this specification may be updated in the near future to reflect this change in name. A pdf copy of this specification can be obtained by calling (303) 773-4701. Many of the specifications listed in this chapter have been adapted from this document.

6.16.1 Tape and Tape Cartridge. The tape shall conform to Magnetic Media Laboratory (MML) Document Number 93-1, *Specification for Rotary Instrumentation Magnetic Recording Tape, 68KA-M (850 oersteds)*, dated 16 February 1993 and the tape cartridge shall conform to SMPTE 32M (1998), *Video Recording – 1/2 in. Type H – Tape and Records*.<sup>15</sup>

6.16.2 Format Types. There are four standard formats: two B formats provide 32 Mbps standard density or 64 Mbps high density for most applications where severe environmental conditions are not encountered, and two E formats provide 16 Mbps standard density or 32 Mbps high density for harsh environments involving extremes of vibration and temperature. A tape made on a standard density system may be reproduced on a high density system. Relative to the B formats, the E formats use a 100 percent larger track pitch, an 81 percent larger track width, and a larger guard band providing a very large margin for accurately tracking and recovering data under extreme conditions. The E formats provide only about one-half the data storage capacity of the B format but can be played back on a B format system.

6.16.2.1 B Format. These formats originate from helical scanner implementations using four helical heads organized in pairs at 180° separation. The heads are both read and write functionally and are supported by two parallel sets of read/write electronics referred to as data channels. Helical track dimensions are given in Figure [6-10](#).

6.16.2.2 E Format. These formats originate from helical scanner implementations using two helical heads with wider track widths at 180° separation on the scanner. The heads are both read and write functionally. One set of read/write or write only electronics is required. Helical track dimensions are given in Figure [6-11](#).

---

<sup>15</sup> Formerly ANSI V98.33M.

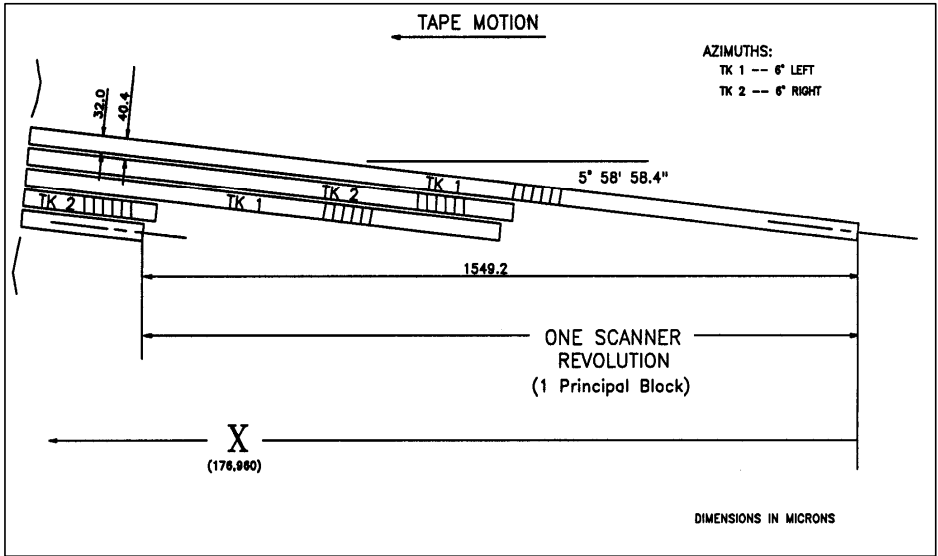

Figure 6-10. Helical track dimensions, B format.

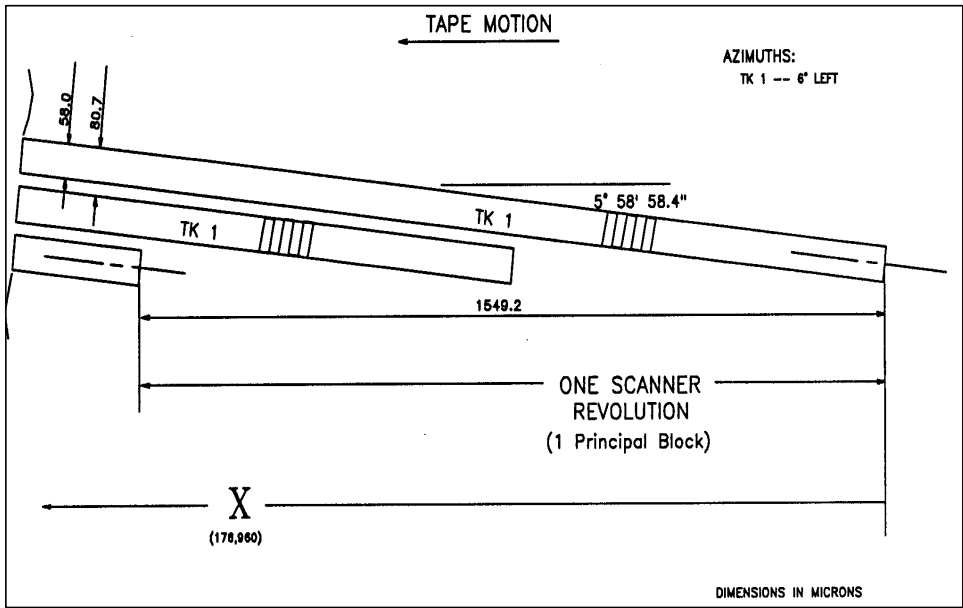

Figure 6-11. Helical track dimensions, E format.

6.16.3 Data Storage. Data are recorded onto 12.65 mm (1/2 in.) wide magnetic tape using both rotating and fixed heads (see Figure 6-12). The rotating heads record data in adjacent track patterns at an inclined angle to the normal tape motion. The fixed heads record data on tracks parallel to the tape motion. The fixed head tracks are used for control and servo purposes and do not directly record user data.

6.16.4 Physical Relationships. Maintaining high accuracy of the ratio between scanner rotational speed and tape speed (1.5492 mm (0.0610 in.) of tape motion per scanner rotation) is critical to maintaining the format geometry. Head and tape speed will vary accordingly with changes in the other two speed parameters. The three speed parameters vary linearly with desired user data rates. Parameters used with a user data rate of 32 Mbps (B) or 16 Mbps (E) are as follows:

user bits/helical track	$2^{17} = 131\,072$ bits (16 kilobytes)
scanner diameter	62.000 mm + 0.008/-0.000 mm (2.44 in. + 0.0003 in.)
scanner rotation speed	3662.1 rpm
tape speed	94.55 mm/sec (3.72 in./sec.)
head/tape speed	11 794.30 mm/sec (464.34 in./sec.)
helix angle (head rotational plane to ref. edge of tape)	5° 56' 7.4" basic dimension
head gap length	refer to Metrum Document 16829019 <sup>16</sup>
tape tension (inlet side of scanner)	0.35N ± 0.02N

6.16.5 Helical Track Organization. Each group of four helical tracks resulting from one complete revolution of the scanner (two helical tracks for the E formats) is termed a principal block on the tape. A principal block is the smallest increment of data that may be written to or read from the tape. Each principal block is assigned a unique number, which is recorded as part of the helical track. Helical tracks containing user data begin with the number 1 and are sequentially incremented on the tape up to the capacity of the cartridge. Whenever new data are appended on a previously recorded cartridge, the new data are precisely located to begin with the next helical track location after the previous end of data point with no interruption or discontinuity in track spacing.

6.16.6 Recorded Information. The following subparagraphs contain additional information.

6.16.6.1 Add overhead bytes generated by error correction encoding algorithms.

---

<sup>16</sup> See paragraph 6.16.

6.16.6.2 Provide preamble and postamble patterns for isolation of the information at the beginning and end of the helical tracks.

6.16.6.3 Provide clock synchronization patterns to facilitate clock recovery at the beginning of each helical track.

6.16.6.4 Add patterns throughout the helical track to maintain synchronization and counteract bit slips during data extraction.

6.16.6.5 Provide redundantly recorded principal block numbers for organizing data on the cartridge.

6.16.6.6 Include a user specifiable volume label for identifying the entire cartridge.

6.16.6.7 Add miscellaneous data used to convey information about the organization of data on the cartridge and within the helical tracks.

6.16.7 Recording Geometry and Physical Dimensions. Included in the following subparagraph are the recording geometry and the physical dimensions.

6.16.7.1 Tape Reference Edge. The tape reference edge for dimensions specified in this section shall be the lower edge as shown in Figure [6-12](#). The magnetic coating, with the direction of tape travel as shown in Figure 6-10, shall be the side facing the observer.

6.16.7.2 Helical Tracks. Contained in the succeeding subparagraphs are the helical tracks attributes.

6.16.7.2.1 Track Widths. The width of a written track shall be 0.032 mm  $\pm$ 0.002 (0.0013 in.  $\pm$  0.000079) for the B formats and 0.058 mm  $\pm$  0.002 (0.0023 in.  $\pm$  0.000079) for the E formats.

6.16.7.2.2 Track Pitch. The distance between the center lines of any two adjacent tracks, measured perpendicular to the track length, shall be 0.0404 mm (0.0016 in.) for the B formats and 0.0808 mm (0.0032 in.) for the E formats.

6.16.7.2.3 Track Straightness. Either edge of the recorded track shall be contained within two parallel straight lines 0.005 mm (0.0002 in.) apart. The center lines of any four consecutive tracks shall be contained within the pattern of four tolerance zones. Each tolerance zone is defined by two parallel lines, which are inclined at an angle of 5° 58' 58.4" basic with respect to the tape edge. The center lines of the tolerance zones shall be spaced 0.0404 mm (0.0016 in.) apart for the B format and 0.0808 mm (0.0032) apart for the E format. The width of the first tolerance zone shall be 0.007 mm (0.00028 in.). The width of tolerance zones two, three, and four shall be 0.011 mm (0.0004 in.). These tolerance zones are established to contain track angle, straightness, and pitch errors.

6.16.7.2.4 Gap Azimuths. The azimuth of the head gaps used for the helical track recording shall be inclined at angles of  $\pm$ 6°  $\pm$ 15' to the perpendicular to the helical track record (see Figures

[6-10](#) and [6-11](#)). For the E formats and for the first and third tracks of every principal block of the B formats, the recorded azimuth is oriented in the clockwise direction with respect to the line perpendicular to the track direction when viewed from the magnetic coating side of the tape. For the B formats, the second and fourth tracks of each principal block are oriented in the counterclockwise direction.

6.16.7.2.5 Track Guard Bands. The nominal unrecorded guard band between any two adjacent helical tracks shall be 0.008368 mm (0.0003 in.) for the B formats and 0.022737 mm (0.0009 in.) for the E formats.

6.16.7.2.6 Track Angle. The track angle shall be 5° 58' 58.4".

6.16.7.2.7 Track Length. The track length shall be 96.619 mm (3.80 in.).

6.16.7.2.8 Physical Recording Density. The maximum physical density of the recording shall be 1930 or 3776 flux transistors per millimeter (ftpmm) respectively for the 32 and 64 Mbps systems.

6.16.7.3 Longitudinal Tracks. The characteristics of the longitudinal tracks are described in the subsequent subparagraphs.

6.16.7.3.1 Servo Track. The servo track is located along the reference edge of the tape as shown in Figure [6-12](#). The azimuth angle of the servo track head gap shall be perpendicular to the recorded track. The recording of the servo track is composed of a recorded pulse (nominally 0.0185 mm (0.0007 in.)) for each principal block on the tape. The recording shall achieve full magnetic saturation for at least half the pulse. The time duration of the pulse is determined by the tape speed to yield this physical dimension. During the interval between pulses, no magnetic recording occurs on the track. The pulse is timed to begin coincident with the midpoint of the principal block (the data channel switches from first to second head). The physical offset from the longitudinal head to the helical heads is shown in Figures [6-10](#), [6-11](#), and [6-12](#) as dimension "X."

6.16.7.3.2 Filemark Track. The filemark track is located near the top of the tape as shown in Figure [6-12](#). The azimuth angle of the filemark track head gap shall be perpendicular to the recorded track. The recording of the filemark track is composed of a series of pulses located in conjunction with the principal block to be marked. Each filemark is composed of three redundant pulses (nominal 0.005 mm (0.0002 in.)). The three pulses are typically spaced 0.029 mm (0.0011 in.) apart with a maximum span of 0.09 mm (0.0035 in.) from the beginning of the first to the beginning of the third. This triplet of pulses is for redundancy against tape flaws and on detection are treated as one filemark regardless of whether 1, 2, or 3 pulses are detected. The filemark pulses are associated with a specific principal block by initiating the first pulse between 4 to 5.5 msec after the midpoint of the principal block. (Data channel switches from first to second head.)

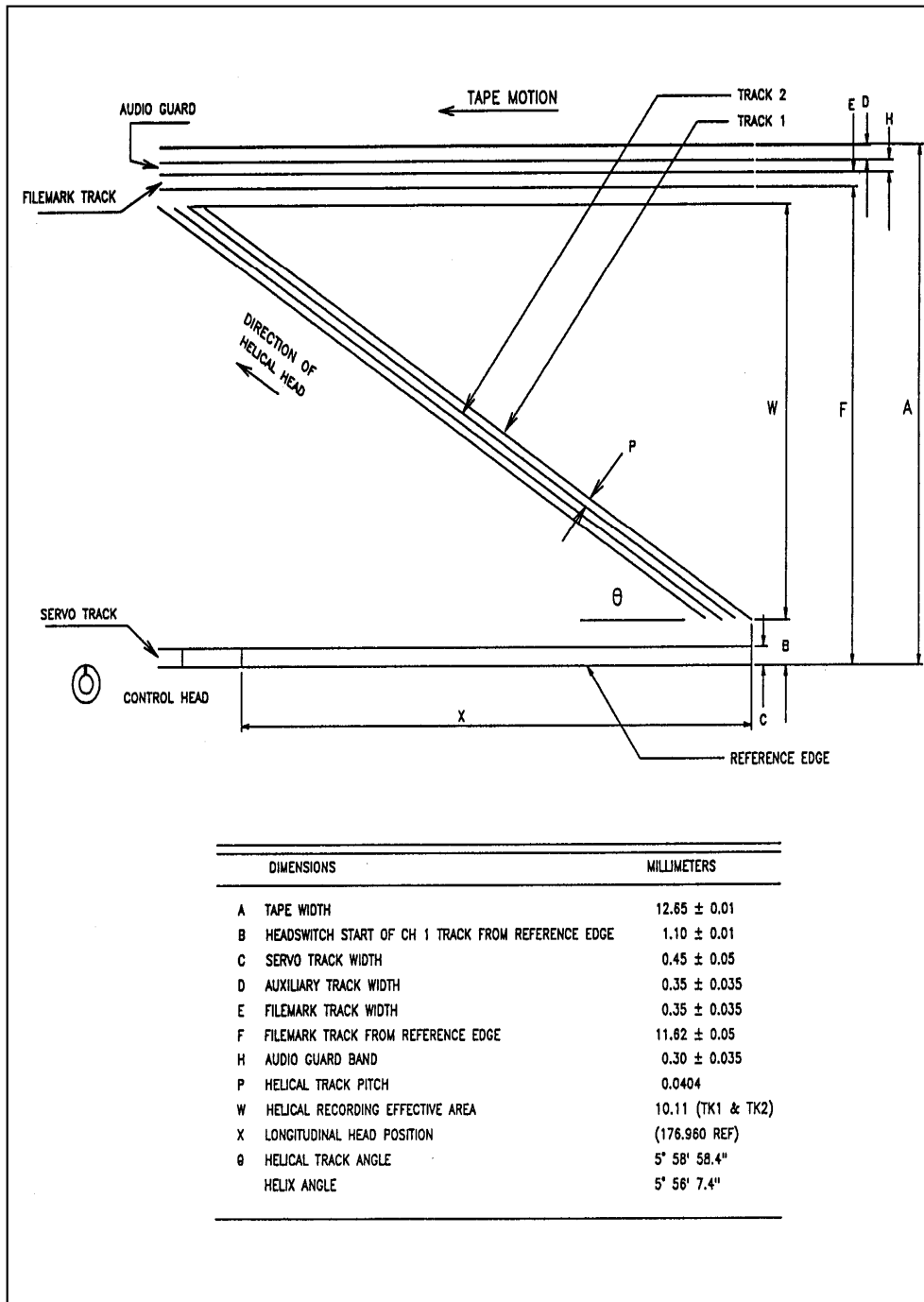

Figure 6-12. Recorded tracks on tape, B format.

6.16.8 Tape Cartridge Format. The physical format of the recording along the length of the tape is shown in Figure 6-13. Immediately following the physical beginning of tape (PBOT) is an unused portion of tape, followed by the cassette format zone, which precedes the logical beginning of tape (LBOT). Principal blocks of user data shall be recorded between LBOT and the logical end of tape (LEOT), which precedes the physical end of tape (PEOT).

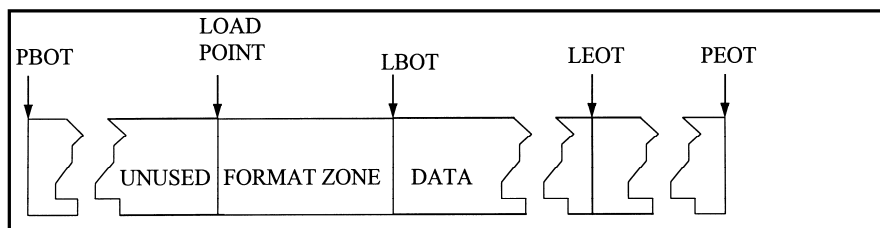

Figure 6-13. Tape cartridge layout.

6.16.8.1 Load Point. The load point is defined as the first point after PBOT accessible by the recording system with the tape fully engaged to the scanner.

6.16.8.2 Format Zone. The format zone begins at the load point, precedes the LBOT, and consists of a minimum of 450 principal blocks recorded on the tape. It provides a run up area for the servo systems and principal block identification allowing precise location of the LBOT where user data begin. The zone must be prerecorded to prepare the cartridge to accept user data. This process involves locating at the load point and beginning recording as soon as tape speed servo lock is achieved. The principal blocks recorded are numbered beginning with a negative number and counting up until principal block 0 is recorded. Principal block 0 shall be the last recorded block in the format zone. Principal blocks recorded in the format zone do not contain user data or error correction coding (ECC) overhead bytes, but do contain the remaining miscellaneous information described in paragraph 6.16.6 and in the helical track data format descriptions. The volume label for the cartridge is irreversibly determined at the time the format zone is recorded.

6.16.8.3 Logical Beginning of Tape. The logical beginning of tape denotes the end of the format zone and the point at which principal blocks containing reproducible data begin. The first principal block containing useful information shall be assigned the number one.

6.16.8.4 Data Zone. Beginning with principal block 1 at LBOT and continuing through to LEOT, the data zone shall be the principal blocks that record user data as well as the added miscellaneous information to allow full reproduction and management of the data on the tape cartridge.

6.16.8.5 Logical End of Tape. The logical end of tape is a physical principal block count. The principal block count for the standard ST-160 tape cartridge is 210 333.

6.16.9 Helical Track Format. The format for writing data into a single helical track is shown in Figure 6-14. The term "bits" refers to actual on tape bit cells. Each helical track begins with a preamble area consisting of 6216 bits of an alternating pattern of three 0 bits and three 1 bits for the 32 Mbps system or 9240 bits for the 64 Mbps system. This 6-bit pattern is repeated 1036 or 1540 times. The preamble is followed by a track synchronization area. This area provides for obtaining registration to the track data patterns. It is composed of four zones of 732 bits each with an alternating 0- and 1-bit pattern that facilitates clock recovery. Each of these four zones is followed by a 36-bit sync pattern. These sync patterns are described more fully in subparagraph 6.16.9.1. The track synchronization area ends with 24 bits of an alternating pattern of three 0 bits and three 1 bits. The central area is where actual user data are recorded in 138 data blocks for the 32 Mbps system or 276 data blocks for the 64 Mbps system. Each data block contains 205 5/6 modulation code frames of interleave data for a total of 1230 bits.

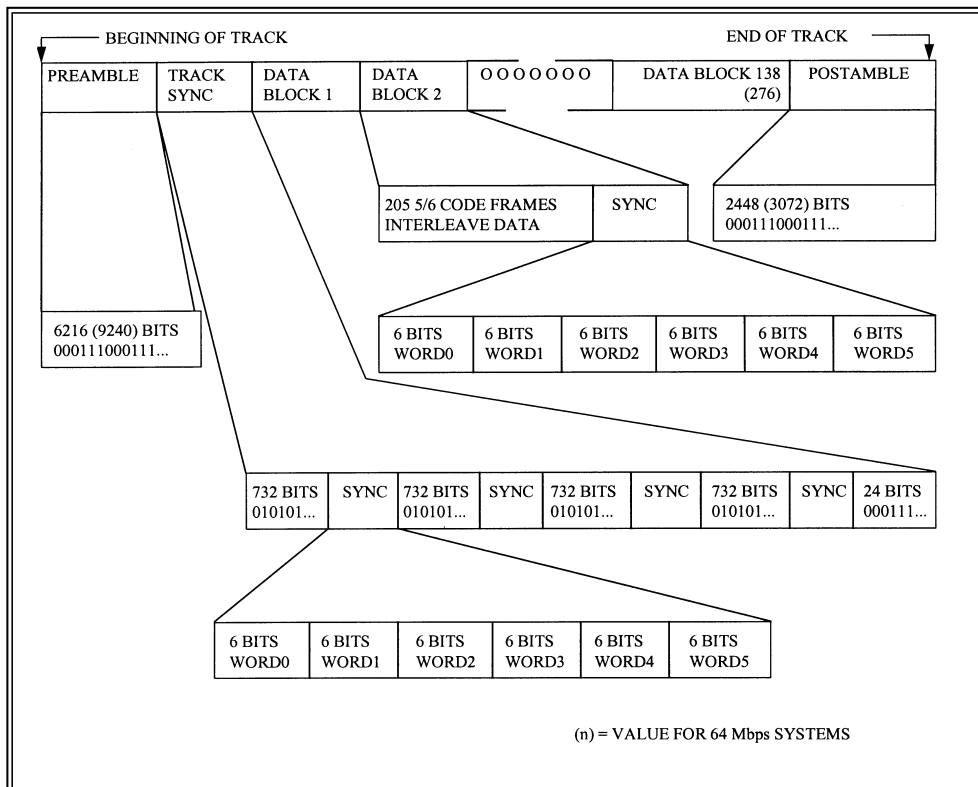

Figure 6-14. Helical track format.



This data is followed by a 36-bit sync pattern. Sync patterns and interleave data are more fully described next. Each helical track ends with a postamble pattern of three 0 bits and three 1 bits. This is the same pattern as the preamble. Compiling all bits yields an overall track total of 186 468 tape bits for the 32 Mbps system and 364 824 tape bits for the 64 Mbps system. Since each contains 131 072 or 262 144 user bits, overheads are 29.7 and 28.1 percent.

6.16.9.1 Sync Patterns. Each helical track contains 142 or 280 sync patterns as shown in Figure 6-14. Four of these are contained in the track sync area with the remaining 138 or 276 distributed at the end of each data block. These sync patterns provide registration to the bit sequence and allow management of bit slips. The track and data sync consists of 36 bits in the form of six 6-bit words. The first five words are the same for all sync words. They are:

WORD0	2A <sub>h</sub>	WORD3	0F <sub>h</sub>
WORD1	2A <sub>h</sub>	WORD4	21 <sub>h</sub>
WORD2	0C <sub>h</sub>		

WORD5 defines which sync word is being issued in the following manner:

<u>Sync Location</u>	<u>Words</u>	<u>Sync Location</u>	<u>Words</u>
Track Sync 1	39 <sub>h</sub>	Data Sync 4	2E <sub>h</sub>
Track Sync 2	35 <sub>h</sub>	Data Sync 5	2B <sub>h</sub>
Track Sync 3	2D <sub>h</sub>	Data Sync 6	2E <sub>h</sub>
Track Sync 4	1D <sub>h</sub>	:	:
Data Sync 1	2B <sub>h</sub>	:	:
Data Sync 2	2E <sub>h</sub>	Data Sync 279	2B <sub>h</sub>
Data Sync 3	2B <sub>h</sub>	Data Sync 280	2E <sub>h</sub>

6.16.9.2 Data Blocks. Each helical track contains 138 or 276 data blocks, which record the user data as well as miscellaneous information used in locating and managing data on the tape cartridge (see Figure 6-14). The construction of these data blocks is performed by each channel's data path electronics. Figure 6-15 illustrates a typical block diagram of a channel data path as described in the following subparagraphs.

6.16.9.2.1 Error Correction Encoding. An interleaved Reed-Solomon (RS) code is used for error detection and correction. An outer ECC is applied to written data first which is an RS (130, 128) for purposes of error detection only. An inner ECC is subsequently applied which is an RS (69, 65) for error detection and correction. The resulting encoded data is stored in a multiple page interleave buffer memory array containing 128 rows by (2•69) or (8•69) columns of encoded user data. For the outer ECC, incoming data is arranged in groups of 128 bytes each. The outer ECC encoder appends 2 check bytes to each 128 byte block. For the inner ECC, the 130 byte group resulting from the outer ECC is divided into two 65 byte blocks. The first 65 byte block (ECC code words 1, 3, 5, ...) contains all user data while the second 65 byte block (ECC code words 2, 4, 6, ...) contains 63 bytes of user data with the last 2 bytes being the check

bytes generated by the outer ECC. The inner ECC encoder appends 4 check bytes to each 65 byte block.

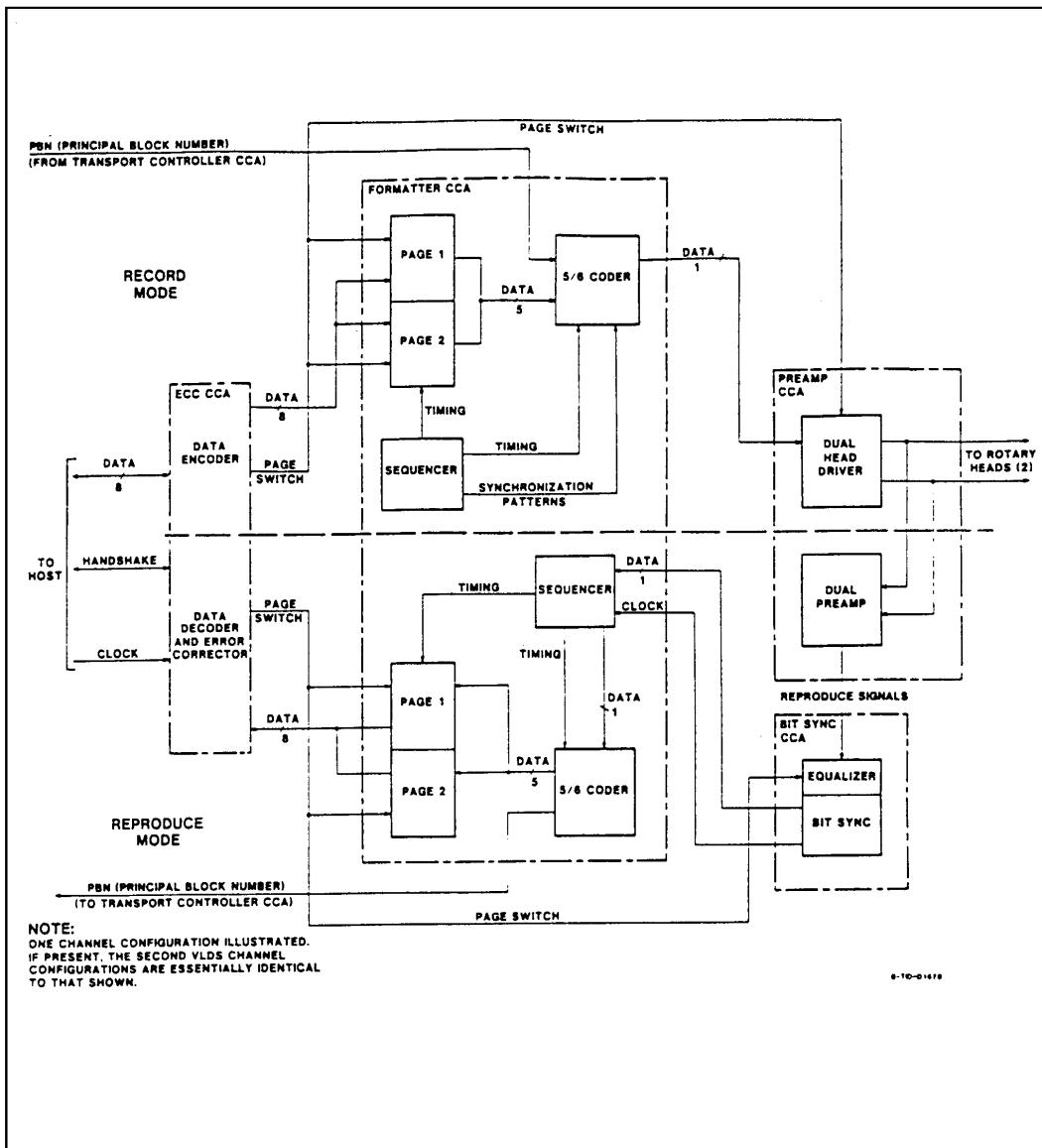

Figure 6-15. Typical VLDS data path electronics block diagram.

Operations in the RS encoder are performed using numbers in a finite field (also called a Galois field (GF)). The field used contains 256 8-bit elements and is denoted GF (256). The representation of GF (256) used is generated by the binary degree eight primitive polynomials.

$$\begin{aligned} p(x) &= x^8 + x^4 + x^3 + x^2 + 1 && \text{outer ECC} \\ p(x) &= x^8 + x^5 + x^3 + x + 1 && \text{inner ECC} \end{aligned}$$

The ECC generator polynomials are:

$$\begin{aligned} G(x) &= (x+a^{24})(x+a^{25}) && \text{outer ECC} \\ G(x) &= (x+1)(x+a)(x+a^2)(x+a^3) && \text{inner ECC} \end{aligned}$$

where "a" denotes the primitive element of the field.

6.16.9.2.2 Interleave Buffer. Encoding data from the two levels of ECC are stored in an interleave buffer memory. The architectures for this memory are shown in Figure 6-16. This buffer allows interleaving of the encoder data. Interleaving spreads adjacent ECC code word bytes within a helical track for the 32 Mbps system to minimize the effect of burst error events. For the 64 Mbps system, interleaving spreads adjacent ECC code word bytes within two helical tracks (two helical tracks per channel per principal block) to further minimize burst error effects. Data to and from the ECC are accessed along horizontal rows in the memory matrix. Data to and from tape are accessed along vertical columns in the memory. Each column in the matrix consists of 128 bytes that will constitute one block in the helical track format (see Figure 6-14).

6.16.9.2.2.1 Exchange of Data with ECC. Addressing of the interleave buffer for exchange of data with the ECC for the 32 Mbps systems is as follows:

<u>ECC Code Word</u>	<u>Address Range (hexadecimal)</u>
1	0080 to 00C4
2	0000 to 0044
3	0180 to 01C4
4	0100 to 0144
5	0380 to 03C4
6	0200 to 0244
.	.
.	.
.	.
253	7E80 to 7EC4
254	7E00 to 7E44
255	7F80 to 7FC4
256	7F00 to 7F44

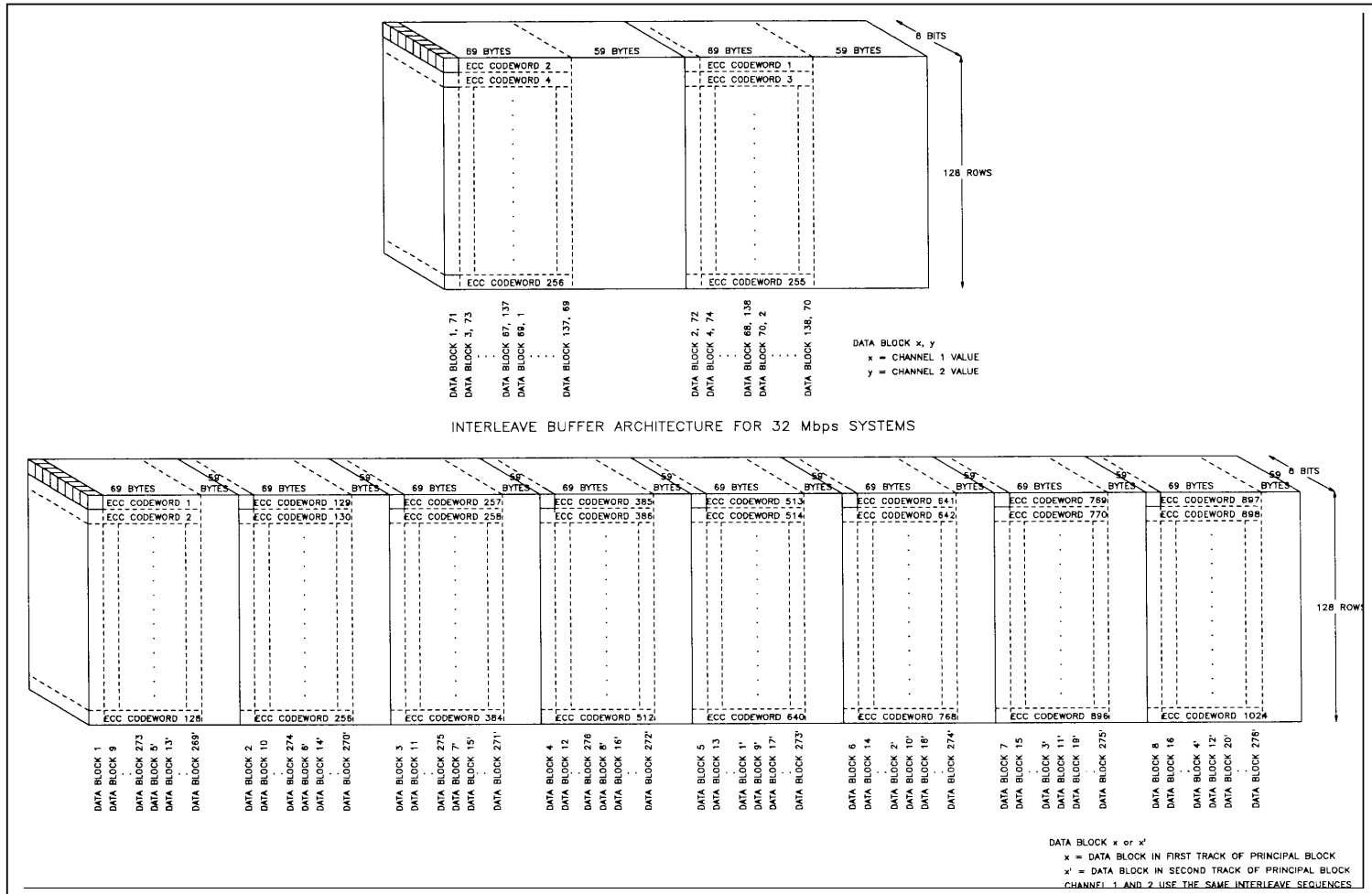

Figure 6-16. Interleave buffer architectures.

Addressing of the interleave buffer for exchange of data with the ECC for the 64 Mbps systems is as follows:

<u>ECC Code Word</u>	<u>Address Range (hexadecimal)</u>
1	00000 to 00044
2	00400 to 00444
3	00800 to 00844
.	.
128	1FC00 to 1FC44
129	00080 to 000C4
130	00480 to 004C4
.	.
256	1FC80 to 1FCC4
257	00100 to 00144
258	00500 to 00544
.	.
512	1FD80 to 1FDC4
513	00200 to 00244
514	00600 to 00644
.	.
1024	1FF80 to 1FFC4

*Each code word is 69 bytes long. The address increments by hex 001 for each byte in a code word. The first data byte sent to/from the ECC for each helical track is stored in location 000.*

Exchange of Data To and From Tape. Addressing of the interleave buffer for exchange of data to and from tape for the 32 Mbps system is as follows:

<u>Data Block</u>	<u>Address Range (Channel 1)</u>	<u>Address Range (Channel 2)</u>
1	0000 to 7F00	0022 to 7F22
2	0080 to 7F80	00A2 to 7FA2
3	0001 to 7F01	0023 to 7F23
4	0081 to 7F81	00A3 to 7FA3
5	0002 to 7F02	0024 to 7F24
6	0082 to 7F82	00A4 to 7FA4
.	.	.
67	0021 to 7F21	0043 to 7F43
68	00A1 to 7FA1	00C3 to 7FC3
69	0022 to 7F22	044 to 7F44
70	00A2 to 7FA2	00C4 to 7FC4

<u>Data Block</u>	<u>Address Range (Channel 1)</u>	<u>Address Range (Channel 2)</u>
71	0023 to 7F23	0000 to 7F00
:	:	:
135	0043 to 7F43	0020 to 7F20
136	00C3 to 7FC3	00A0 to 7FA0
137	0044 to 7F44	0021 to 7F21
138	00C4 to 7FC4	00A1 to 7FA1

*Each data block is 128 bytes long. The address increments by hex 0100 for each byte in a data block. The first byte sent to/from tape for each channel 1 helical track is stored in location 0000. The first byte sent to/from tape for each channel 2 helical track is stored in location 0022.*

Addressing of the interleave buffer for exchange of data to/from the 64 Mbps system is as follows:

<u>Data Block</u>	<u>Address Range (hexadecimal)</u>
1	00000 to 1FC00
2	00080 to 1FC80
3	00100 to 1FD00
4	00180 to 1FD80
:	:
8	00380 to 1FF80
9	00001 to 1FC01
10	00081 to 1FC81
:	:
275	00122 to 1FD22
276	001A2 to 1FDA2
1'	00222 to 1FE22
2'	002A2 to 1FEA2
3'	00322 to 1FF22
:	:
8'	001A3 to 1FDA3
9'	00223 to 1FE23
10'	002A3 to 1FEA3
:	:
275'	00344 to 1FF44
276'	003A4 to 1FFA4

*Each data block is 128 bytes long. The address increments by hex 0400 for each byte in a data block. The first byte sent to or from tape for both channels is stored in location 00000. The interleave buffer extends across both helical tracks in a principal block for each channel, thus*

*the data block number “n” refers to the data block in the first helical track of the principal block and the data block number “n’ ” denotes the data block number in the second helical track of the principal block.*

6.16.9.2.3 8 to 5 Conversion. Data being moved from the interleave buffer to tape is read from the memory in 8-bit bytes and is immediately converted to 5-bit groups in preparation for modulation coding. During reproduction, this conversion occurs in reverse fashion. The algorithm for conversion is detailed in Metrum Specification 16829019.<sup>17</sup>

6.16.9.2.4 Miscellaneous Information Inclusion. Each data block in the helical track includes one additional bit added to the data set prior to modulation coding. Each data block removed from the interleaved buffer memory consists of 128 bytes of ECC encoded user data totaling 1024 bits. Conversion from 8-bit bytes to 5-bit groups results in 204 groups plus 4 bits. A miscellaneous information bit is added to each data block as the 1025th bit to complete 205 full 5-bit groups. Miscellaneous information is currently defined only in the first helical track of each principal block. The remaining three helical tracks (1 in the E format) contain no defined miscellaneous bits and are reserved for future expansion. Any reserved miscellaneous information bits shall be recorded as 0 bits. The defined purposes of miscellaneous information bits in the first helical track of each principal block are the following:

<u>Data Block</u>	<u>Miscellaneous Bit Definition</u>
1 to 20 inclusive	First copy of 20-bit principal block number: 2s complement binary; least significant bit in data block 1; most significant bit in data block 20.
21 to 40 inclusive	Second copy of 20-bit principal block number: 2s complement binary; least significant bit in data block 21; most significant bit in data block 40.
41 to 60 inclusive	Third copy of 20-bit principal block number: 2s complement binary; least significant bit in data block 41; most significant bit in data block 60.
61 to 76 inclusive	Volume label: 16-bit binary; least significant bit in data block 61; most significant bit in data block 76.
77 to 80 inclusive	Revision number: 4-bit code; value at time of writing is 0001 (1 <sub>H</sub> ).

---

<sup>17</sup> See paragraph 6.16.

Data Block

Miscellaneous Bit Definition

81 to 84 inclusive

4-bit tape information code as follows:

- 81 bit = 0 denotes all helical data was input as user digital data.
- 81 bit = 1 denotes input data stream to each channel. The ECC was 15 bytes of user digital data beginning with first byte plus 1 inserted byte from a different source in a repeating fashion. This bit must be uniformly set for the entire cartridge including the format zone. It is used to support mixing of digitized analog data into the digital stream and separation on reproduction.
- 82 bit = 0 denotes cartridge size is ST-120 for purposes of determining LEOT. This bit must be set for the entire cartridge including the format zone.
- 82 bit = 1 denotes cartridge size is ST-160 for purposes of determining LEOT. This bit must be set uniformly for the entire cartridge including the format zone.

83 and 84

Reserved for additional tape information coding.

85 to 138 or 276 inclusive

Reserved for future expansion.



6.16.9.2.5 Modulation Code. Data is encoded using a 5/6 modulation code that has a spectral null at dc. The coding algorithm employed has a code word digital sum (CWDS) maximum of  $\pm 2$  with a maximum run length of 6 bits. The 205 5-bit groups resulting from the 8 to 5 conversion (including the inserted miscellaneous bit) undergo this coding to form the final 5/6 code frames that are physically recorded in the data blocks of the helical track format. The algorithm for coding is detailed in Metrum Specification number 16829019.

### **6.17 Multiplex/Demultiplex (MUX/DEMUX) Standards for Multiple Data Channel Recording on 1/2 Inch Digital Cassette (S-VHS) Helical Scan Recorder/Reproducer Systems.**

For recording and reproducing multiple channels on 1/2 inch digital cassette (S-VHS) helical scan recorders, the asynchronous real-time multiplexer and output reconstructor (ARMOR) multiplex/demultiplex format is recommended. The ARMOR data format is an encoding scheme that may be used to multiplex multiple asynchronous telemetry data channels into a single composite channel for digital recording, transmission, and subsequent demultiplexing into the original constituent channels.

6.17.1 General. Data types supported by the ARMOR format are PCM, analog, decoded IRIG time, and 8-bit parallel. MIL-STD-1553B<sup>18</sup> data is encoded into an IRIG 106 Chapter 8 serial PCM stream prior to multiplexing into the ARMOR format. Voice channels are encoded in the same way as all other analog channels. The composite channel is formatted into fixed bit-length, variable word-length frames. A constant aggregate bit rate and a fixed frame bit-length are established for each multiplex by an algorithm that is dependent on the number, type, and rate of the input channels. The aggregate bit rate and frame bit length result in a fixed frame rate for each multiplex. The ARMOR encoding scheme captures the phase of each input channel relative to the start of each composite frame. The demultiplexing process may then use the captured phase information to align the reconstruction of the constituent channels relative to a reproduced constant frame rate.

6.17.2 Setup Block Format. In addition to defining the organization of the frames containing the multiplexed data, the ARMOR format incorporates the definition of a "setup block" that contains the parameters necessary to demultiplex the associated data frames. The setup block is included in the composite stream at the start of each recording to preserve with the data the information necessary to decode the data. Appendix L defines the setup block format and content.

6.17.3 Multiplexer Format. The definition of the ARMOR multiplex format has two parts. The frame structure definition describes the organization of the composite data frame, which changes from one multiplex to the next. The channel coding definition describes the encoded data word format for each data type, which is the same for all multiplexers.

---

<sup>18</sup> MIL-STD 1553B (1996), Digital Time Division Command/Response Multiplex Data Bus.

6.17.3.1 **Frame Structure.** The sequence of steps used to establish the multiplexed frame structure, shown in Figure 6-17, is explained in Table 6-12. The process involves putting the sync, PCM, parallel (PAR), time code, and analog channels into a frame. The filler blocks may consist of either constant (hex FF) bytes or analog samples, depending upon the constituent input channel mix. The PCM Sample Start Bit Point and the Parallel Sample Start Bit Point are based on calculations of the master oscillator, pacer, and the bit rate of the slowest PCM and word rate of the slowest parallel channels respectively. The pacer is a clock pulse that is programmed to a multiple of the fastest analog channel sample rate. These calculations assure that the first word of the slowest PCM channel or the first word of the slowest parallel channel is not placed too early in the composite frame. If necessary to satisfy these Start Bit Point calculations, filler in the form of analog channel words or hex FF (if no analog words are available) is used to force the first PCM or PAR word later in the composite frame. Compatibility with specific legacy versions of the format requires the use of the appropriate equations, which are embodied in a software program, refer to Calculex Part No. 199034-0002.<sup>19</sup>

Step 1				2	3	4				5	6				7								
1	2	3	4					1	2	...	m					1	2	...	m				
Sync				Filler (or time Code)				PCM Channel Blocks				Filler				PAR Channel Blocks				Filler			

Figure 6-17. The steps of the build process.

<sup>19</sup>Part Number 199034-0002, available from CALCULEX, Inc., P.O. Box 339, Las Cruces, NM 88004 (505) 525-0131 or by email to info@calculex.com.

**TABLE 6-12. SCANLIST BUILD STEPS**

(Reference scanlist in Figure <a href="#">6-17</a> )		
Step #1	Sync	The sync is made up of four bytes of 8 bits totaling 32 bits: FE 6B 28 40
Step #2	Time Code	If time code exists, it is placed after the sync in three words of bit length 24, 24, and 16. Multiple time codes are placed in ascending hardware sequence, as identified in the setup block.
Step #3	Filler (PCM Start Bit)	If required, either filler or analog channels are placed next, depending on the calculation of the PCM Sample Start Bit Point. If no analog (or voice) channels are included in the multiplex, hex value “FF” filler is inserted in the frame as required to satisfy the PCM Sample Start Bit Point calculation. When analog channels are part of the multiplex, analog words are used in place of hex FF filler to minimize the formatting overhead.
Step #4	PCM Channels	The PCM channels are placed next in ascending order of speed with the slowest channel first. Multiple channels at the same speed are placed in ascending hardware sequence, as identified in the setup block.
Step #5	Filler (PAR Start Bit)	If required, either filler or analog channels are placed next, depending on the calculation of the PAR Sample Start Bit Point. If no analog (or voice) channels are included in the multiplex, hex FF filler is inserted in the frame as required to satisfy the PAR Sample Start Bit Point calculation. When analog channels are part of the multiplex, any remaining analog words that were not inserted in the frame at step 3 are used in place of hex FF filler to minimize the formatting overhead channel.
Step #6	PAR Channels	The PAR channels are placed next in ascending order of speed with the slowest channel first. Multiple channels at the same speed are placed in ascending hardware sequence, as identified in the setup block.
Step #7	Filler (Analog Channels)	All remaining analog words that have not been used for filler in steps 3 and 5 are placed next, followed by any additional filler required to satisfy the pacer divisor calculation.

6.17.3.2 Pacer Divisor Calculation. The number of analog samples per ARMOR frame for each analog channel must be evenly divisible into the number of bits per ARMOR frame. The initial bits per ARMOR frame are calculated to minimize the aggregate bit rate of the composite. Filler is then added to satisfy the divisibility rule to set the pacer clock speed. This step is referred to as the pacer divisor calculation since the pacer itself is derived from the same master oscillator as the aggregate bit rate clock.

6.17.3.3 ARMOR Channel Coding. Each input data channel is encoded into 8-, 12-, 16-, or 24-bit words, depending on the type of channel. The bit length of an ARMOR frame is always an integer multiple of eight, so 12-bit words must occur an even (multiple of two) number of times within each frame. The data within a frame is serially concatenated most significant bit first. Table 6-13, which is an example of an ARMOR frame with two analog, one parallel, four PCM, and one time code channel, is referenced in the following descriptions.

<b>TABLE 6-13. SAMPLE ARMOR FRAME</b>			
<b>Frame Item</b>	<b>Description</b>	<b>Words/Frame</b>	<b>Bits/Word</b>
Sync Pattern	X'FE6B2840'	1	32
Time Code Ch#1	Encoded Time	2	24
Time Code Ch #1	Encoded Time	1	16
Filler	X'FF'	7	8
PCM Ch#1	Encoded User Data	130	16
PCM Ch#2	Encoded User Data	162	16
PCM Ch#3	Encoded User Data	226	16
PCM Ch#4	Encoded User Data	321	16
Analog Ch #1	Encoded User Data	100	12
Analog Ch #2	Encoded User Data	20	12
Analog Ch #1	Encoded User Data	2	16
Analog Ch #1	Encoded User Data	260	8

6.17.3.4 Sync Pattern. All ARMOR frames begin with the fixed 32-bit sync pattern hexadecimal FE6B2840.

6.17.3.5 Time Code Channels. When time code channels are present in an ARMOR multiplex, their data words always immediately follow the sync pattern or another time code channel. Time is encoded as 64 bits in two 24-bit words and one 16-bit word. Table 6-14 defines the individual bits of the time code words. The encoded time is the time at the start of the ARMOR frame.

<b>TABLE 6-14. TIME CODE WORD FORMAT</b>			
<b>BIT</b>	<b>WORD1</b>	<b>WORD 2</b>	<b>WORD3</b>
23	D9	0	
22	D8	S6	
21	D7	S5	
20	D6	S4	
19	D5	S3	
18	D4	S2	
17	D3	S1	
16	D2	S0	
15	D1	SE	0
14	D0	NT	0
13	0	0	HN13
12	H5	0	HN12
11	H4	MS11	HN11
10	H3	MS10	HN10
9	H2	MS9	HN9
8	H1	MS8	HN8
7	H0	MS7	HN7
6	M6	MS6	HN6
5	M5	MS5	HN5
4	M4	MS4	HN4
3	M3	MS3	HN3
2	M2	MS2	HN2
1	M1	MS1	HN1
0	M0	MS0	HN0

<b>LEGEND</b>	
D = Day of year	
H = Hour of day	
M = Minutes past the hour	
S = Seconds past the minute	
MS = Milliseconds past the second	
HN = Hundreds of nanoseconds past the millisecond	
SE = Sync error (time code decoding error)	
NT = No time code (input signal detect fail)	

6.17.3.6 PCM Channels. User PCM data is encoded into 16-bit words. The number of 16-bit words (per channel) in each frame is approximately two percent greater than the number required to store the user data during the frame time period. These overhead words are included to compensate for minor variations in user data clock rates. In order to record the number of allocated frame bits that actually contain user data, the first two 16-bit words are redundant copies of a bit count. In Figure 6-13, PCM Channel #1 has 130 words: two count words and 128 data words. The bit count in either one of the redundant count words records the number of bits in the 128 data words that are actually user PCM data (most significant bit first). All remaining bits are filler. The first user data bit in the most significant bit location of the third channel word (the first data word following the redundant count words) was the first bit to be received after the start of the ARMOR frame.

6.17.3.7 Analog Channels. Analog data is digitized into either 8-bit or 12-bit samples using offset binary notation (a sample of X'00' or X'000' is the largest negative value). No overhead words or bits are included with analog channel data because input sampling is synchronous to the

start of the ARMOR frame. The first sample of each channel was captured at frame start time with all remaining samples evenly spaced throughout the frame time. Note that the location of the analog channel words within the composite ARMOR frame has no correlation with the time between the start and end of the frame when the analog samples were captured (digitized). The first sample of the 100 Analog Channel #1 words and the first sample of the 20 Analog Channel #2 words in Figure 6-13 were both captured (digitized) at the same instant in time, which was the frame start time. Voice is a special case of an analog channel in that it is always 8-bit samples.

6.17.3.8 Parallel Channels. The encoding of parallel input channels is very similar to PCM encoding. Approximately two percent more than the minimum number of words necessary to store the user data during one ARMOR frame period are allocated to each parallel channel. The first two 16-bit words of each channel are redundant count words that record the actual number of allocated data words that contain user data. The remaining allocated words contain filler. Figure 6-13 has two entries for Parallel Channel #1. The first entry shows the two (redundant) 16-bit count words and the second entry shows the number of allocated 8-bit data words for the channel. The number of 8-bit data words that contain user data is determined by examining either of the two count words. The first data word for each parallel channel was the first word received after the start of the ARMOR frame.

6.17.4 ARMOR Format Compatibility. Compatibility with the ARMOR format can be divided into two distinct cases. In the first case, the user is playing back a legacy tape (made with legacy multiplexer hardware and software) on non-legacy demultiplexer hardware and software. In the second case, the user is creating a tape on non-legacy multiplexer hardware and software for future playback by legacy demultiplexer hardware and software.

In the first case, the legacy tape contains a setup block (see paragraph 6.17.2) at the start of the recording. The setup block contains the information necessary for the user to demultiplex the data records on the tape. The bit rate field in the setup block header section specifies the rate at which the legacy recording was generated. The saved scanlist field in the setup block trailer section specifies the exact sequence and size of the sync, data, and filler words in the recording.

In the second case, the user must first generate an ARMOR setup block at the start of the recording. Subsequent data records must then be formatted in accordance with the specification in the setup block. Setup block creation is described in [Appendix L](#).

6.17.5 ARMOR Format Validation. The CALCULEX, Inc. ARMOR Format Verification Program (AFVP) may be used to determine if an independently generated multiplex is compatible with existing legacy hardware. The AFVP reads the setup block (see paragraph 6.17.2) from the data set under test and validates the data set frame structure. Please refer to IRIG 118, Vol III. The AFVP may be obtained from CALCULEX.<sup>20</sup>

---

<sup>20</sup> Part Number 198007-0001 may be obtained from CALCULEX, Inc. P.O. Box 339, Las Cruces, NM 88004 (505) 525-0131 or by email request to [info@calculex.com](mailto:info@calculex.com).



## 6.18 Recorder Command and Control Mnemonics (CCM)

This section describes a set of standard commands and replies that can control tape, disk, and solid-state recorders. Not all commands may be applicable to all types of recorders or recorder implementations. Manufacturers who claim compliance with this Standard shall identify in an Interface Control Document for each recorder model the specific command and reply subset that is implemented. An important aspect of the CCM standard is the required command-response protocol. For each command issued to a recorder, there shall be exactly one response from the recorder, and the response shall begin immediately upon conclusion of the command input. There shall be no delay between the receipt of the command at the recorder and the transmission of the reply by the recorder. Commands that initiate recorder functions, which require time to complete, shall be replied to immediately, and the host shall poll the recorder status to determine when the function is complete. There shall be no unsolicited status output from the recorder, with one exception. This exception is a boot message upon leaving the POWER ON state, notifying the host that the recorder is ready to accept commands. The boot command shall contain a single asterisk as the last character. Thereafter, the recorder will only output in response to a command input. (A hardware reset or a software .RESET shall return the recorder to the POWER ON state.)

6.18.1 Recorder State Transitions. Figure 6-18 is a generic state transition diagram for standard recorder operation. Upon application of power, the recorder enters the POWER ON state, during which commands are not accepted. Upon conclusion of the power-up sequence, the recorder shall execute a built-in test (BIT) to verify recorder functionality. Upon successful conclusion of the BIT, the recorder shall enter the IDLE state. The following facts describe and explain the state transition diagram.

- a. The STARTING and STOPPING (ENDING) states may require zero (none) or more wait states, as necessary, for a particular recorder and command implementation.
- b. Some recorders can record without playing, play without recording, or record and play at the same time.
- c. For those recorders that require data clocks, the record clock is always external (provided by the source of the data). The playback clock, on the other hand, may be externally or internally supplied, and when externally supplied, may or may not be synchronous to (equal to or derived from) the record clock.
- d. Some functions are implemented using multiple commands. For example, a conventional longitudinal recorder shuttle command is implemented as a .FIND command with the starting point identifier, followed by a .SHUTTLE command with the ending point identifier. Once the initial .SHUTTLE command is received, the recorder automatically initiates a FIND sequence when the end point is reached, and then automatically initiates a PLAY sequence when the start point is found. This is shown on the state transition diagram as the decision box "ANOTHER COMMAND PENDING".

- e. Some recorders are physically able to record over existing data. This standard prevents recording over existing data by forcing the record point to the current end of data (EOD). An erase command is provided to enable reuse of the media by resetting the record point to the beginning of media (BOM).
- f. Some recorders are physically able to replay data in either the forward sequence or reverse sequence. Forward is the sequence in which the data was recorded, whereas reverse is the opposite sequence. This standard only requires and supports replay in the forward sequence.

6.18.2 Command Summary. All commands must comply with the following syntax rules and are summarized as available commands in Table [6-15](#).

- a. All recorder commands are simple ASCII character strings delimited by spaces.
- b. All commands begin with an ASCII period (“.”) and, with the single exception of the .TMATS command, end with the first occurrence of a carriage return and line-feed terminator sequence.
- c. Parameters are separated from the commands and from each other with ASCII space characters.
- d. With one exception, command words and parameters may not include spaces. The one exception is the [*text string*] parameter for the .EVENT command.
- e. Multiple consecutive terminators and extraneous space characters are ignored.
- f. Each command is followed with either a simple response and an ASCII asterisk (“\*”) response terminator or the asterisk response terminator only, indicating the recorder is ready for the next command.
- g. All numeric parameters, with one exception, are decimal numbers. The one exception is the [*mask*] parameter for the .CRITICAL command, which is hexadecimal.
- h. Three commands, .FIND, .REPLAY, and .SHUTTLE, have numeric parameters that required units of measure. The [*mode*] parameter is used to specify the unit of measure (time, feet, or blocks.) If the [*mode*] parameter is omitted, the recorder shall use the most recently entered [*mode*].
- i. A [*time*] parameter value has five parts: days, hours, minutes, seconds, and milliseconds. Any part not entered defaults to zero except days, which defaults to don’t care (current day.) A period (“.”) identifies the start of the millisecond part, a hyphen (“-” separates the day from the hours, and colon characters (“:”) separate the hours, minutes, and seconds. The following are valid times: 123- (day only), 17 (hours only), 17:30 (hours and minutes), 17:30:05 (hours, minutes, seconds), 17:0:05 (hours, minutes, seconds), 17:30:05.232 (hours, minutes, seconds, milliseconds), 123-17 (day, hours), 123-17:30 (day, hours, minutes), etc.



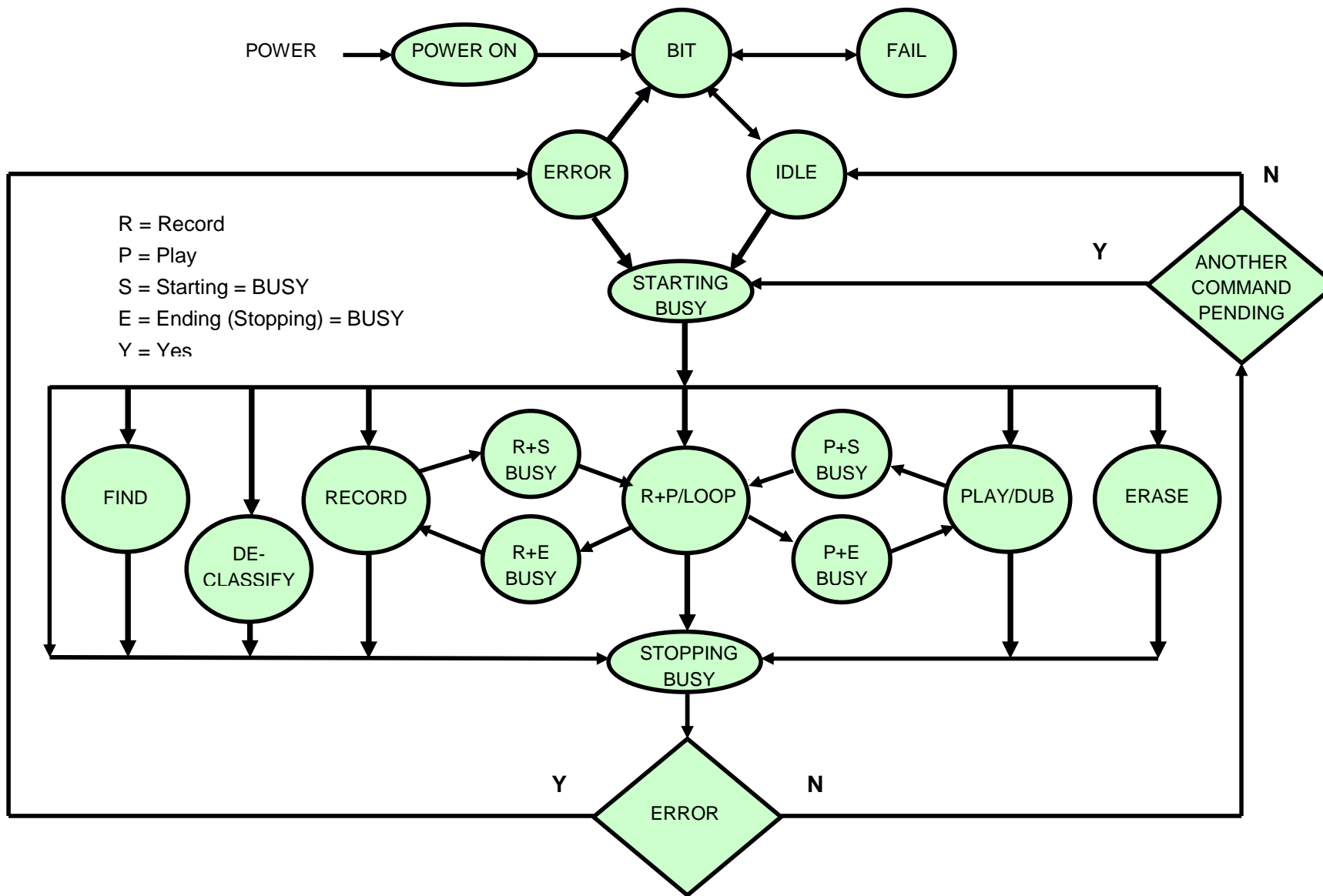

Figure 6-18. Recorder state transition diagram.

**TABLE 6-15 COMMAND SUMMARY**

<b>Command</b>	<b>Parameters*</b>	<b>Description</b>
.BIT		Runs all of the built-in-tests
.CRITICAL	[ <i>n</i> [ <i>mask</i> ] ]	Specify and view masks that determine which of the .HEALTH status bits are critical warnings
.DECLASSIFY		Secure erases the recording media
.DISMOUNT		Unloads the recording media
.DUB	[ <i>location</i> ]	Same as .PLAY but with internal clock
.ERASE		Erases the recording media
.EVENT	[ <i>text string</i> ]	Display event table or add event to event table
.FILES		Displays information about each recorded file.
.FIND	[ <i>value</i> [ <i>mode</i> ] ]	Display current locations or find new play point
.HEALTH	[ <i>feature</i> ]	Display detailed status of the recorder system
.HELP		Displays table of "dot" commands
.LOOP		Starts record and play in read-after-write mode
.MEDIA		Displays media usage summary
.MOUNT		Powers and enables the recording media
.PLAY	[ <i>location</i> ]	Reproduce recorded data starting at [ <i>location</i> ] using external clock
.RECORD	[ <i>filename</i> ]	Starts a recording at the current end of data
.REPLAY	[ <i>endpoint</i> [ <i>mode</i> ] ]	Same as .SHUTTLE but with internal clock
.RESET		Perform software initiated system reset
.SETUP	[ <i>n</i> ]	Displays or selects 1 of 16 (0...15) pre-programmed data recording formats
.SHUTTLE	[ <i>endpoint</i> [ <i>mode</i> ] ]	Play data repeatedly from current location to the specified endpoint location using external clock
.STATUS		Displays the current system status
.STOP	[ <i>mode</i> ]	Stops the current recording, playback, or both
.TIME	[ <i>start-time</i> ]	Displays or sets the internal system time
.TMATS	{ <i>mode</i> } [ <i>n</i> ]	Write, Read, Save, or Get TMATS file

\* Parameters in braces “{ }” are required. Parameters in brackets “[ ]” are optional. When optional parameters are nested (“[xxx [yy] ]”), the outer parameter (xxx) must be specified in order to also specify the inner parameter (yy).

6.18.3 Command Error Codes. Issuing invalid commands (bad syntax) or illegal commands (not accepted in the current system state) result in error code responses prior to the asterisk response terminator when a command cannot be completed. Table 6-16 shows possible error codes and the conditions under which they occur.

TABLE 6-16. COMMAND ERROR CODES		
Error	Description	Conditions
00	INVALID COMMAND	Command does not exist
01	INVALID PARAMETER	Parameter is out of range, or wrong alpha-numeric type
02	INVALID MODE	Command cannot be executed in the current state
03	NO MEDIA	Recording media is dismounted or not installed
04	MEDIA FULL	Command cannot be executed because there is no free space available on the recording media
05	COMMAND FAILED	Command failed to execute for any reason other than those listed above

The error message is displayed before the asterisk response terminator with an ASCII “E” identifier.

Example:

```
.RECORD
E 03
*
```

6.18.4 Command Parameters and Responses. Each of the commands, the command parameters, and the recorder responses to the commands are described in the following sections.

6.18.4.1 .BIT: The **.BIT** command runs the built-in test (BIT) on the recorder. The prompt is returned immediately after the test is started. The **.BIT** command is only valid in the IDLE, ERROR, and FAIL states. During the BIT, the user must periodically check the status until the test is complete. While in BIT mode, the percent completion is shown with the **.STATUS** command. The result of the **.BIT** command is go/no-go status indicated by the end state. If the system returns to the IDLE state, the BIT was successful. If the system goes to the FAIL state, the BIT failed and further system-specific diagnostics are required. The ASCII “S” in the response is the identifier of a **.STATUS** response.

Example:

```
.BIT
*.STATUS
S 02 0 0 21%
*.STATUS
S 02 0 0 74%
*.STATUS
S 01 0 0
*
```



Parameters in braces “{}” are required. Parameters in brackets “[ ]” are optional. When optional parameters are nested (“[xxx [yy] ]”), the outer parameter (xxx) must be specified in order to also specify the inner parameter (yy).

6.18.4.2 **.CRITICAL** [*n* [*mask* ]]: The **.CRITICAL** command is used to view and specify the critical warning masks used with the **.HEALTH** command. An encoded 32-bit status word is displayed with the **.HEALTH** command for each feature in the recorder. The **.CRITICAL** command allows the user to specify which status word bits constitute critical warnings. If a bit in the **.CRITICAL** mask word for a feature is set, then the corresponding **.HEALTH** status word bit for that feature signals a critical warning. The **.CRITICAL** command without any parameters returns the mask word for each feature in ascending feature order. The **.CRITICAL** command with a single parameter, the feature number, returns the list of descriptive warning strings and status word bit associations for the specified feature. The **.CRITICAL** command with both the feature number parameter and the 8-character ASCII hexadecimal mask value parameter specifies a new mask value for the feature. All mask values in the command responses are hexadecimal.

Example #1: The command with no parameters returns the mask for each feature.

```
.CRITICAL
1 FFFFFFFF
2 00000300
3 00000001
4 00000003
:
:
15 00000002
16 00000000
*
```

Example #2: The command with the feature number parameter only, no mask value, returns all of the possible warning text strings for the specified feature and shows which .HEALTH status word bit is associated with the particular warning.

```
.CRITICAL 4
00000001 No Clock
00000002 No Minor Frame Lock
00000004 Slow Clock
00000100 No Major Frame Lock
00000200 Sync Bit Error
*
```

Example #3: Entering both the feature number parameter and the mask value parameter resets the mask for the specified feature.

```
.CRITICAL 4 0000103
4 00000103
*
```

6.18.4.3 .DECLASSIFY: The **.DECLASSIFY** command erases all recorded data using an approved declassification procedure and sets the record point to the beginning of media (BOM).

	This command will permanently erase all recorded data. Data cannot be recovered once this command has been executed!
---	--

The prompt is returned immediately after the operation is started. During declassify, the user must periodically check the status until the operation is complete. While in DECLASSIFY state, the percent completion is shown with the .STATUS command.

Example:

```
.DECLASSIFY
*.STATUS
S 04 0 0 23%
*.STATUS
S 04 0 0 84%
*.STATUS
S 01 0 0
*
```

6.18.4.4 .DISMOUNT: The **.DISMOUNT** command disables and, if necessary, removes power from the active recording media. The media may be removed only after this command is issued.

Example #1:

```
.DISMOUNT
*
```

Example #2: If a failure occurs an error message is displayed before the prompt.

```
.DISMOUNT
E 03
*
```

6.18.4.5 .DUB [location]. The **.DUB** command is identical to the **.PLAY** command except that it specifies the use of the internal playback clock to retrieve the recorded data.

6.18.4.6 .ERASE: The **.ERASE** command erases all data and resets the record point to the beginning of media (BOM).

	This command will permanently erase all recorded data. Data cannot be recovered once this command has been executed!
---	--

The prompt is returned immediately after the operation is started. During erase, the user must periodically check the status until the operation is complete. While in ERASE state, the percent completion is shown with the .STATUS command.

Example:

```
.ERASE
*.STATUS
S 03 0 0 23%
*.STATUS
S 03 0 0 84%
*.STATUS
S 01 0 0
*
```

6.18.4.7 **.EVENT** [*text string*]. The **.EVENT** command adds an entry to the recorder event file or displays all of the current event file entries. If a non-blank text string is included with the command, a new event entry is appended to the event file with the text string in the message field of the event entry. The text string may be any length, but only the first 48 bytes, starting with the first non-blank character but including all subsequent blanks, are saved in the event file entry. If no text string is provided with the message, the current event file entries are displayed as a list of character strings showing the event sequence number, the absolute event time based on the recorder system time, the current media address (block number) at the time the event entry is created, and the optional text string.

Example:

```
.EVENT -
*.EVENT This text was supplied with the .EVENT command
*.EVENT x
*.EVENT
1 001-00:13:58.109 101231 -
2 001-00:14:11.106 433213 This text was supplied with the
.EVENT command
3 001-17:44:06.677 2427654 x
*
```

6.18.4.8 **.FILES**: The **.FILES** command displays a list of character strings showing information about each recording session (file). Each string in the list contains the file number, file name, starting block number, file size in bytes, start day, and start time of the file. For those systems that also store the end day and time of each file, the end day and time may be added to the end of each file string. File names may not contain space or asterisk characters. If user names are not assigned to individual recordings, the default file names shall be "file1," "file2," etc. Each file string shall be formatted as shown in the following example (with optional end day and end time).

Example:

```
.FILES
1 TPD-10 10000 272760832 001-00:13:58.109 001-00:14:03.826
2 TPD-11 92884 425984000 001-00:14:11.106 001-00:14:28.602
3 file3 350790 305430528 123-17:44:06.677 123-17:44:13.415
*
```

6.18.4.9 **.FIND** [*value* [*mode*]]: The **.FIND** command is used to report the current record and play point or to set the play point to the desired location within the recorded data. The desired location can be expressed in a number of different formats or “modes:” time, blocks, and feet. When the command is entered without any parameters, the recorder returns the current record point and current play points, using the current default mode. The default mode is declared each time a mode parameter is supplied with the **.FIND** command, the **.REPLAY** command, or the **.SHUTTLE** command. Thereafter, the mode parameter may be omitted and the recorder will use the default mode. The mode keywords are **TIME**, **BLOCKS**, and **FEET**.

The location specified in the value parameter of the **.FIND** command can be numeric or one of six keywords: **BOM** (beginning of media), **BOD** (beginning of data), **EOD** (end of data), **EOM** (end of media), **BOF** (beginning of file), and **EOF** (end of file.) These keywords may be used with or without a mode parameter. Numeric location values, whether accompanied by the mode keyword or not, must be valid for the specified or default mode. Blocks and feet are entered as decimal integer numbers. Time is entered as specified in paragraph [6.18.2 item i](#).

Example #1: Display the current record point and play point. The default mode is blocks.

```
.FIND
F 1022312 BOD
*
```

Example #2: Find a specific time in the recorded data.

```
.FIND 15:33:12 TIME
*.STATUS
S 08 0 0 41%
*.STATUS
S 08 0 0 84%
*.STATUS
S 01 0 0
*.FIND
F 102-16:18:27.000 102-15:33:12.000
*
```



6.18.4.10 .HEALTH [*feature*]: The **.HEALTH** command provides a standard mechanism for vendor-specific status information to be conveyed to the user. Entering the command without the optional parameter displays a list of system-specific “features” and an encoded status word for each feature. Entering a decimal feature number parameter with the command decodes the status word for a single feature and displays a list of messages pertaining to the feature, one for each set bit in the status word. The choice of features, their ordering, their descriptions, their encoded status words, and their decoded message lists are all vendor specific. This standard only requires that the syntax of the responses to the **.HEALTH** command conform to the following rules:

- a. If no features are implemented, the response to a **.HEALTH** command is the response terminator asterisk.
- b. Implemented features are numbered consecutively starting with 1 and displayed in ascending numerical order.
- c. The description of a feature may not contain an asterisk character.
- d. The feature list response (no feature number parameter supplied with the command) is a sequence of text strings, each containing the decimal feature number, the 8-character ASCII hexadecimal representation of the 32-bit status word for the feature, a text feature description, and a carriage return and line feed terminator. The value of the 32-bit status word for a “healthy” feature shall be all zeros. If a feature is disabled, the 8-character ASCII hexadecimal string shall be replaced with eight ASCII hyphen “-” characters.
- e. The individual feature response (feature number parameter supplied with the command) is a sequence of descriptive text strings, one for each set bit in the feature status word. Each string is terminated with a carriage return and line feed.

The **.CRITICAL** command is used to specify and view the mask word for each feature that determines if a set **.HEALTH** status word bit adds to the total non-critical or critical warning counts displayed with the **.STATUS** command.

Example #1:

```

.HEALTH
1 00000000 Time Code Input
2 00000000 Voice Input
3 ----- PCM Input #1
4 00000103 PCM Input #2
   :
15 00000000 1553 Input #2
16 00000000 Temp Monitor
*
```

Example #2:

```
.HEALTH 4
No Clock
No Minor Frame Lock
No Major Frame Lock
*
```

6.18.4.11 HELP: The **.HELP** command displays a list showing a summary of the serial "dot" commands and parameters.

Example:

```
.HELP
.BIT
.CRITICAL [n [mask]]
.DECLASSIFY
.DISMOUNT
.DUB [location]
.ERASE
.EVENT [message]
.FILES
.FIND [value [mode]]
.HEALTH [feature]
.HELP
.LOOP
.MEDIA
.MOUNT
.PLAY [location]
.RECORD [filename]
.REPLAY [endpoint [mode]]
.RESET
.SETUP [n]
.SHUTTLE [endpoint [mode]]
.STATUS
.STOP [mode]
.TIME [start-time]
.TMATS {mode} [n]
*
```

6.18.4.12 LOOP: The **.LOOP** command is used to put the recorder into read-after-write mode, recording and simultaneously playing back the recorded data. If the recorder is already recording when the **.LOOP** command is issued, the command starts the playback at the current record point without affecting the recording.

Example:

```
.STATUS
S 01 0 0
* .LOOP
* .STATUS
S 07 0 0 35%
*
```

6.18.4.13 .MEDIA: The **.MEDIA** command displays the media usage summary. It shows the number of bytes per block, the number of blocks used and the number of blocks remaining, respectively.

Example:

```
.MEDIA
MEDIA 32768 1065349 6756127
*
```

6.18.4.14 .MOUNT: The **.MOUNT** command applies power and enables the recording. For systems with multiple memory canisters or media cartridges, the effect of the **.MOUNT** command on each canister or media cartridge is defined in advance with vendor-specific commands.

Example:

```
.MOUNT
*
```

6.18.4.15 .PLAY [*location*]: The **.PLAY** command starts a playback of the data at either the current play point or at the location specified in the optional parameter with the command using the user's external data clock. The current play point is defined to be the media location immediately following the most recently played data. If no **.PLAY** command has been issued since recorder power-on, the current play point is the beginning of data. The location parameter has two forms, [block\_number] and [filename [block\_offset]]. If the first character of the location parameter is numeric, the entire parameter must be numeric and it specifies the block number address at which to start the playback. When the first character of the location parameter is alphabetic, the parameter is the filename to playback and a second optional parameter that specifies the numeric 0-origin block offset into the named file may be included with the **.PLAY** command. To begin playing at a location other than a block number or file, use the **.FIND** command to position the play point to the desired location.

Example:

```
.PLAY file1 250
*
```

6.18.4.16 .RECORD [*filename*]: The **.RECORD** command starts a new recording. The optional file name parameter is an ASCII string with up to eleven characters, beginning with an alphabetic character, and with no spaces or asterisks. If the file name parameter is omitted, the filename will be of the form “file*n*”, where *n* is the file number. The recording will continue until the recording media is full or until the **.STOP** command is issued.

Example:

```
.RECORD
*
```

6.18.4.17 .REPLAY [*endpoint* [*mode*]]: The **.REPLAY** command is identical to the **.SHUTTLE** command, except that it specifies that the internal clock is to be used to retrieve the data.

6.18.4.18 .RESET: The **.RESET** command performs a software initiated reset of the recorder, returning the recorder to the power-on state.

Example:

```
.RESET
*
```

6.18.4.19 .SETUP [*n*]: The **.SETUP** command chooses one of 16 pre-defined setups stored in the recorder. The optional parameter is a one or two digit decimal setup number from 0 to 15. The current setup may be displayed by omitting the setup number parameter.

Example #1:

```
.SETUP
SETUP 10
*
```

Including the setup number changes the setting.

Example #2:

```
.SETUP 5
SETUP 5
*
```

6.18.4.21 **.SHUTTLE** [*endpoint* [*mode*]]: The **.SHUTTLE** command initiates a repeated playback from the current play point to the end point specified in the command, using an external clock to retrieve the data. The syntax of the endpoint parameter is identical to that of the **.FIND** command.

Example:

```
.SHUTTLE 1430 FEET
*
```

6.18.4.21 **.STATUS**: The **.STATUS** command displays the current state of the recorder and two counts. The first is the total number of non-critical warning bits currently set and the second is the total number of critical warning bits currently set. If the recorder is in any state other than **FAIL**, **IDLE**, **BUSY**, or **ERROR**, the command also displays a progress percentage, the meaning of which is dependent on the specific state. Whenever the recorder is transitioning between states and the transition is not instantaneous, the **.STATUS** command will return the **BUSY** state. The **ERROR** state is entered when the currently executing command does not complete successfully. For example, when a **.FIND** command is unable to locate the specified position on the media, the recorder transitions to the **ERROR** state. Table 6-17 shows the various states by numerical code and describes the meaning of the progress percentage for each state. An ASCII “S” character identifies a **.STATUS** command response.

TABLE 6-17. RECORDER STATES		
State Code	State Name	Progress Description
00	FAIL	---
01	IDLE	---
02	BIT	Percent complete
03	ERASE	Percent complete
04	DECLASSIFY	Percent complete
05	RECORD	Percent media recorded
06	PLAY	Percent recording played
07	RECORD & PLAY	Percent media recorded
08	FIND	Percent complete
09	BUSY	---
10	ERROR	---

Example #1:

```
.STATUS
S 03 0 0 84%
*
```

For states that do not have a progress indication, that field is omitted in the response.

Example #2:

```
*.STATUS
S 01 0 0
*
```

6.18.4.22 **.STOP** [*mode*]: The **.STOP** command stops a recording, playback, or both. The optional mode parameter may be either the word **RECORD** or the word **PLAY**. If the optional mode parameter is not specified, both recording and playing, or either of the two modes if other is not active, will be stopped. Using the parameter enables either recording or playing to be stopped without affecting the other when both are active.

Example #1:

```
.STOP
*
```

The current state can be displayed with the status command.

Example #2:

```
*.STATUS
S 07 0 0 26%
*.STOP PLAY
*.STATUS
S 05 0 0 26%
*
```

The **.STOP** command returns an error if the recorder is not in the appropriate state.

Example #3:

```
*.STATUS
S 01 0 0
*.STOP
E 02
*
```

6.18.4.23 .TIME [start-time]: The **.TIME** command displays or sets the internal systems time. The optional start-time parameter is formatted as shown in the example below. Without a parameter, this command displays the current system time. The timestamps recorded with user data are derived from this clock.

Example #1:

```
.TIME  
TIME 001-23:59:59.123  
*
```

To set the time, enter a value expressed in days, hours, minutes, seconds and milliseconds. For example:

```
.TIME 123-13:01:35  
TIME 123-13:01:35.000  
*
```

Trailing values and punctuation may be omitted (zero is default).

Example #1:

```
.TIME 123-  
TIME 123-00:00:00.000  
*
```

Example #2:

```
.TIME 15:31  
TIME 000-15:31:00.000  
*
```

Example #3:

```
.TIME 15:31:20  
TIME 000-15:31:20.000  
*
```

6.18.4.24 **.TMATS** {mode} [n]: The **.TMATS** command provides a vendor-independent mechanism for loading a setup file into the recorder and retrieving a setup file from the recorder. The required mode parameter must be one of the following four words: WRITE, READ, SAVE, or GET. Writing or reading a TMATS file transfers the file between the external host and the recorder's internal volatile memory buffer. Saving or getting a TMATS file transfers the file between the recorder's internal volatile memory buffer and the recorder's internal non-volatile setup file storage area. To store a new setup file in the recorder, the **.TMATS WRITE** command is first used to transfer the file to the recorder, followed by a **.TMATS SAVE [n]** command to store the file in non-volatile memory. The numeric setup file number parameter is not valid with the **.TMATS WRITE** command. When saving the file to non-volatile memory, the optional setup file number parameter may be entered to designate a specific setup number (see the **.SETUP** command.) If the setup file number parameter is not specified with the **.TMATS SAVE** command, the file number defaults to setup 0. The **.TMATS GET [n]** command performs the inverse of the **.TMATS SAVE** command, retrieving the specified or default (0) file from non-volatile to volatile memory within the recorder. The **.TMATS READ** command transfers the file currently in the recorder's volatile setup file buffer to the host.

Termination of the **.TMATS WRITE** command string is unique. All other command strings terminate with the first occurrence of a carriage return and line feed sequence. The **.TMATS WRITE** command string does not terminate until the occurrence of a carriage return and line feed pair followed by the word **END** and another carriage return and line feed pair.

Example #1: The **.TMATS WRITE** command includes the TMATS file followed by the word **END**.

```
.TMATS WRITE
G\DSI\N=18;
G\DSI-1:TimeInChan1;
G\DSI-2:VoiceInChan1;
G\DSI-3:1553Chan01;
      :
      :
P-8\IDC8-1:0;
P-8\ISF2-1:ID;
P-8\IDC5-1:M;
END
*
```



Example #2: The .TMATS READ command returns the file currently in the volatile buffer.

```
.TMATS READ
G\DSI\N=18;
G\DSI-1:TimeInChan1;
G\DSI-2:VoiceInChan1;
G\DSI-3:1553Chan01;
:
:
P-8\IDC8-1:0;
P-8\ISF2-1:ID;
P-8\IDC5-1:M;
*
```

Example #3: The .TMATS SAVE command stores the file in the volatile buffer to the designated non-volatile file memory in the recorder.

```
.TMATS SAVE 3
*
```

Example #4: The .TMATS GET command retrieves the designated file from non-volatile file memory in the recorder and puts it in a buffer that can be read by the user.

```
.TMATS GET 3
*
```

6.18.5 Command Validity Matrix. Table [6-18](#) identifies the recorder states where each of the serial commands is valid. The legend at the bottom of the table explains the matrix entry codes. Two codes, 3 and 4, identify states in which the associated command may or may not be valid due to system-specific implementation. Recorder users should assume that a command is not supported in a system-specific state (code 3 or 4) unless the specific recorder's Interface Control Document assures that support is provided.

6.18.6 Required Command Subset. Table [6-19](#) identifies the minimum subset of commands that must be implemented for each recorder type to be compliant with this standard.

**TABLE 6-18. COMMAND VALIDITY MATRIX**

STATE COMMAND	BUILT-IN TEST	BUSY	DECLASSIFY	ERASE	ERROR	FAIL	FIND	IDLE	PLAY	POWER ON	RECORD	RECORD & PLAY
.BIT					X	X		X				
.CRITICAL	1		1	1	1	1	1	1	1		1	1
.DECLASSIFY					X			X				
.DISMOUNT					2			2				
.DUB					X			X			X	
.ERASE					X			X				
.EVENT	3				3	3	3	3	3		3	3
.FILES	X				X	X	X	X	X		X	X
.FIND					X			X			X	
.HEALTH	X		X	X	X	X	X	X	X		X	X
.HELP	X		X	X	X	X	X	X	X		X	X
.LOOP					X			X			X	
.MEDIA	X				X	X	X	X	X		X	X
.MOUNT					2			2				
.PLAY					X			X			4	
.RECORD					X		4	X	4			
.REPLAY					X			X			X	
.RESET	X	X	X	X	X	X	X	X	X		X	X
.SETUP	1		1	1	1	1	1	1	1		1	1
.SHUTTLE					X			X			X	
.STATUS	X	X	X	X	X	X	X	X	X		X	X
.STOP							X		X		X	X
.TIME	1		1	1	1	1	1	1	1		1	1
.TMATS					X			X				

**Legend**

- X= Always valid.
- 1 = Query function always valid. Changing masks, setup, or time only valid in IDLE or ERROR.
- 2 = MOUNT and DISMOUNT only valid if not mounted or dismounted, respectively.
- 3 = Query always valid. Declaring always valid in record, but not recording is system-specific.
- 4 = Simultaneous recording and playing is system-specific.

<b>TABLE 6-19. REQUIRED COMMANDS</b>			
<b>Command</b>	<b>Recorder Type</b>		
	<b>Tape</b>	<b>Solid State</b>	<b>Disk</b>
.BIT	M	M	M
.CRITICAL	O	O	O
.DECLASSIFY	O	M	M
.DISMOUNT	O	O	O
.DUB	O	O	O
.ERASE	O	M	M
.EVENT	O	O	O
.FILES	O	O	O
.FIND	M	M	M
.HEALTH	O	O	O
.HELP	O	O	O
.LOOP	O	O	O
.MEDIA	M	M	M
.MOUNT	O	O	O
.PLAY	M	M	M
.RECORD	M	M	M
.REPLAY	O	O	O
.RESET	M	M	M
.SETUP	O	O	O
.SHUTTLE	O	O	O
.STATUS	M	M	M
.STOP	M	M	M
.TIME	O	O	O
.TMATS	O	O	O
<b>Legend</b>			
M = Mandatory		O = Optional	

## CHAPTER 7

### MAGNETIC TAPE STANDARDS

#### 7.1 General

These standards define terminology, establish key performance criteria, and reference test procedures for longitudinally-oriented oxide, unrecorded magnetic tape designed for instrumentation recording,<sup>21</sup> and reference specifications for 19 mm (0.75 in) cassettes designed for digital helical scan recording and S-VHS cassettes designed for 12.65 mm (1/2 in) digital helical scan recording. Classes of instrumentation recording tapes include high resolution (HR) tapes used for wide band recording, high density digital (HDD) tapes used for high density digital PCM recording, and high energy (HE) tapes used for double density recording.

Coercivities of HR and HDD tapes are in the range of 275 to 350 oersteds. High energy tapes have coercivities of 600 to 800 oersteds. Nominal base thickness is 25.4  $\mu\text{m}$  (1.0 mil) and nominal coating thickness is 5  $\mu\text{m}$  (200 microinches) for all tapes. Where required, limits are specified to standardize configurations and to establish the basic handling characteristics of the tape. Limits placed on the remaining requirements must be determined by the tape user in light of the intended application and interchangeability requirements imposed on the tape (see Table 7-4 for examples of suggested requirement limits).

#### 7.2 Definitions

Underlined terms appearing within definitions indicate that these terms are defined elsewhere in paragraph 7.2. For the purpose of this standard, the following definitions apply.

7.2.1 Back Coating. A thin coating of conductive material (for example, carbon) bonded to the surface of a magnetic tape opposite the magnetic-coated surface for reducing electrostatic charge accumulation and for enhancing high-speed winding uniformity. Resistivity of the back coating should be 1 megohm per square or less, whereas the oxide-coated magnetic surface resistivity is much higher (also see magnetic oxide coating).

7.2.2 Base. The material on which the magnetic oxide coating (and back coating, if employed) is applied in the manufacture of magnetic tapes. For most applications, polyester-base materials are currently employed.

7.2.3 Bias Level. The level of high frequency ac bias current or voltage in a direct record system needed to produce a specified level of an upper band edge (UBE) frequency sine-wave signal at a particular tape speed. Usually adjusted to produce maximum output or increased beyond maximum to depress the output 2 dB.

---

<sup>21</sup> Federal Specifications may be used to replace paragraphs contained in this chapter where applicable. High output and HDD tapes are not included in the Federal Specifications. Other standards are referenced in paragraph 1.0, Appendix D.

7.2.4 Bi-Directional. Ability of a magnetic tape to record and to reproduce a specified range of signals within specified tolerances of various characteristics when either end of the tape on the reel is used as the leading end.

7.2.5 Binder. Material in which the magnetic oxide particles or back-coating particles are mixed to bond them to the base material.

7.2.6 Blocking. Failure of the magnetic coating to adhere to the base material because of layer-to-layer adhesion in a wound tape pack.

7.2.7 Center Tracks. On a recorded tape, center tracks are those which are more than one track distance from either edge of the tape, for example, tracks 2 through 13 of a 14-track tape or tracks 2 through 27 of a 28-track tape.

7.2.8 Dropout. A reproduced signal of abnormally low amplitude caused by tape imperfections severe enough to produce a data error. In digital systems, dropouts produce bit errors.

7.2.9 Edge Tracks. The data tracks nearest the two edges of a recorded magnetic tape, for example, tracks 1 and 14 of a 14-track tape.

7.2.10 Erasure. Removal of signals recorded on a magnetic tape to allow reuse of the tape or to prevent access to sensitive or classified data. Instrumentation recorders and reproducers do not usually have erase heads, so bulk erasers or degaussers must be employed.

7.2.11 E-Value. The radial distance by which the reel flanges extend beyond the outermost layer of tape wound on a reel under a tape tension of 3.33 to 5.56 newtons (12 to 20 ounces of force) per inch of tape width. Inadequate E-value may prohibit the use of protective reel bands.

7.2.12 High-Density Digital Magnetic Tape. Instrumentation magnetic tape with nominal base thickness of 25.40  $\mu\text{m}$  (1 mil) and coercivity of 275 to 350 oersteds used to record and reproduce high-density digital (PCM) signals with per-track bit densities of 590 b/mm (15 kb/in.) or greater.

7.2.13 High-Energy Magnetic Tape. Magnetic tapes having coercivity of 600 to 800 oersteds and nominal base thickness of 25.4  $\mu\text{m}$  (1 mil) used for double density analog recording and high-density digital recording above 980 b/mm (25 kb/in.).

7.2.14 High-Resolution Magnetic Tape. Instrumentation magnetic tape used for recording on wide band recorder and reproducer systems. The HR and HDD tapes may have identical coatings and coercivities (275 to 350 oersteds) but differ in the extent and type of testing conducted by the manufacturer.

7.2.15 Layer-to-Layer Signal Transfer (Print Through). Transfer of a signal to a layer of a wound magnetic tape originating from a signal recorded on an adjacent layer of tape on the same reel. Saturation-level recorded signals and tape storage at elevated temperatures are likely contributors to this effect.

7.2.16 Magnetic Oxide Coating. Material applied to a base material to form a magnetic tape. The magnetic oxide coating contains the oxide particles, the binder, and other plasticizing and lubricating materials necessary for satisfactory operation of the magnetic tape system (also see back coating).

7.2.17 Manufacturer's Centerline Tape (MCT). A tape selected by the manufacturer from his production, where the electrical and physical characteristics are employed as reference standards for all production tapes to be delivered during a particular contractual period. Electrical characteristics include, but are not limited to, bias level, record level, output at 0.1 UBE, and wavelength response. The MCTs are not usually available for procuring agency use.

7.2.18 Manufacturer's Secondary Centerline Tape (MSCT). A tape selected by a manufacturer from his production and provided in lieu of an MCT. On the MSCT, the electrical characteristics may depart from the MCT characteristics, but calibration data referenced in the MCT are provided. All other characteristics of the MSCT are representative of the manufacturer's product.

7.2.19 Modulation Noise. Noise riding on a reproduced signal that is proportional to the amplitude of the recorded signal (below saturation) and results from tape-coating irregularities in particle size, orientation, coercivity, and dispersion.

7.2.20 Record Level. The level of record current or voltage required to achieve a specified reproduce output level with bias level previously set to the correct value. In direct record systems, standard record level is the level of a 0.1 UBE frequency signal required to produce 1 percent third harmonic distortion in the reproduced output signal because of tape saturation.

7.2.21 Scatterwind. Lateral displacements of tape wound on a reel which gives an irregular appearance to the side surfaces of a tape pack. Scatterwind can result from such things as poorly controlled tape tension, guiding, static electrical charge, and poor tape slitting.

7.2.22 Shedding. Loss of magnetic coating from tape during operation on a tape transport. Excessive shedding causes excessive dropout.

7.2.23 Short Wavelength Output Uniformity. A measure of high-frequency reproduce signal amplitude uniformity caused by oxide coating variations.

7.2.24 Upper Band Edge. The highest frequency that can be recorded and reproduced at a particular tape speed in the direct record mode. The UBE signals are used in setting bias level; 0.1 UBE signals are used to set record level.

7.2.25 Wavelength Response. The record and reproduce characteristic of a magnetic tape which depends on tape formulation, coating thickness, and other tape physical parameters and is a function of the wavelength recorded on the tape (tape speed divided by signal frequency) rather than the actual frequency recorded.

7.2.26 Working Length. Length of tape usable for reliable recording and reproduction of data. Actual tape length on a reel exceeds the working length to provide for tape start and stop at each end of the reel without loss of data.

7.2.27 Working Reference Tape (WRT). A tape or tapes of the same type as an MCT or MSCT selected by the user and calibrated to the MCT or MSCT. The WRTs are employed in conducting tests on tape types during a procurement activity and for aligning and testing recorder and reproducer systems to minimize running the MCT or MSCT.

### 7.3 General Requirements for Standard Instrumentation Tapes and Reels

The following subparagraphs describe the requirements for tapes and reels.

7.3.1 Reference Tape System. To establish a set of test procedures which can be performed independently and repeatably on different manufacturers' tape transports, a centerline reference tape system employing MCT, MSCT, or WRTs as required, should be used. The reference tape system provides a centerline tape against which tape or tape recorder specifications may be tested or standard tapes for aligning operational recorders.

7.3.1.1 Manufacturer's Centerline Tape. The electrical characteristics provided for a manufacturer's centerline tape include, but are not limited to, bias level, record level, wavelength response, and output at 0.1 UBE wavelength. The physical characteristics of the MCT shall also represent the manufacturer's production and shall be representative of all production tape delivered during any resultant contractual period (see subparagraph [7.2.17](#)).

7.3.1.2 Manufacturer's Secondary Centerline Tape. On the MSCT, the electrical characteristics are calibrated to the manufacturer's reference tape, and calibration data are supplied with the MSCT. The physical characteristics of the MSCT shall represent the manufacturer's production (see subparagraph [7.2.18](#)).

7.3.1.3 Working Reference Tape. Working reference tapes shall be of the same type as those under procurement or test and shall be used in place of a MCT or MSCT for all applicable test procedures (see subparagraph [7.2.27](#)).



The MCT or MSCT shall be a full-length tape of 25.4 mm (1 in.) width, wound on a 266.7 mm (10 1/2 in.) or 355.6 mm (14 in.) reel or as designated by the tape user. The center one-third of the working tape length shall be used as the calibrated working area.

7.3.1.4 Test Recorder and Reproducer. A laboratory quality test recorder shall be designated for use with the reference tape system during any magnetic tape procurement and test program. The recorder selected shall meet the requirements specified in Chapter 6.

7.3.1.5 MCT/MSCT/WRT Use. Using MCT or MSCT as a reference, the tape user performs all tests necessary to determine if the manufacturer's centerline performance values meet operational and recorder requirements. All acceptable centerline tapes are retained by the tape user as references in subsequent acceptance test procedures performed in support of resultant contracts or contractual periods. A working reference tape, which has been calibrated to an MCT or MSCT, is used as the actual working reference in the applicable testing procedures outlined in Volume III, RCC Document 118. Dropout tests should use a tape other than the MSCT or WRT.

7.3.2 Marking and Identifying. See Federal Specification W-T-1553B.<sup>22</sup>

7.3.3 Packaging. Specified by user.

7.3.4 Winding. The tape shall be wound on the reel or hub with the oxide surface facing toward the hub ("A" wind). The front of the wound reel is defined as that flange visible when viewing the tape reel with the loose end of the tape hanging from the viewer's right.

7.3.5 Reels and Hubs. Reels and hubs shall conform to the tape user specified requirements of Federal Specification W-R-175 (also see [Appendix D](#)).

7.3.6 Radial Clearance (E-Value). For all tape lengths, use 3.175 mm (0.125 in.) (see subparagraph [7.2.11](#)).

7.3.7 Flammable Materials. Flammable materials shall not be a part of the magnetic tape. Flammable materials will ignite from a match flame and will continue to burn in a still carbon dioxide atmosphere.

7.3.8 Toxic Compounds. Compounds which produce toxic effects in the environmental conditions normally encountered under operating and storing conditions as defined in subparagraph [7.4.2](#) shall not be part of the magnetic tape. Toxicity is defined as the property of the material which has the ability to do chemical damage to the human body. Highly toxic or corrosive compounds produced under conditions of extreme heat shall be identified and described by the manufacturer.

#### **7.4 General Characteristics of Instrumentation Tapes and Reels**

The following subparagraphs describe the general characteristics for tapes and reels.

7.4.1 Dimensional Specifications. Magnetic tape shall be supplied on flanged reels in the standard lengths, widths, and base thicknesses outlined in Table 7-1. Reel and hub diameters are taken from Federal Specification W-R-175.

---

<sup>22</sup> There are four W-T-1553 specifications relating to different coercivity and dropout rates.



**TABLE 7-1. TAPE DIMENSIONS**

<u>Dimension</u>	<u>millimeters</u>	<u>inches</u>	
Tape Width	25.4 +0 -0.10	1.000 +0 -0.004	
Tape Thickness			
Base Material	0.025	0.0010	Nominal <sup>(1)</sup>
Oxide Thickness	0.005	0.0002	Nominal
<b>Tape Length by Reel Diameters</b> (reels with 76 mm (3 in.) center hole)			
	<u>Nominal Tape Length</u> <sup>(2)</sup>	<u>Minimum True Length</u> <sup>(3)</sup>	
Reel Diameter			
266 mm (10.5 in.)	1100 m (3600 ft)	1105 m (3625 ft)	
" " " "	1400 m (4600 ft)	1410 m (4625 ft)	
356 mm (14.0 in.)	2200 m (7200 ft)	2204 m (7230 ft)	
" " " "	2800 m (9200 ft)	2815 m (9235 ft)	
381 mm (15.0 in.)	3290 m (10 800 ft)	3303 m (10 835 ft)	
408 mm (16.0 in.)	3800 m (12 500 ft)	3822 m (12 540 ft)	

**Notes:**

- (1) Actual tape base material thickness slightly less because of manufacturing conventions.
- (2) Original dimensions are in feet. Metric conversions are rounded for convenience.
- (3) Tape-to-flange radial clearance (E-value) is 3.18 mm (0.125 in.).

7.4.2 Environmental Conditions. The tape shall be able to withstand, with no physical damage or performance degradation, any natural combination of operating or non-operating conditions as defined in subparagraphs 7.4.2.1 and 7.4.2.2.

7.4.2.1 Tape Storing Conditions. Magnetic tape is subject to deterioration at temperature and humidity extremes. In some cases the damage is reversible, but irreversible damage may occur, especially with long-term storage in unfavorable conditions.

7.4.2.2 Operating Environment. Recommended limits:

<u>Condition</u>	<u>Range</u>
Temperature:	4 to 30 °C (40 to 85 °F)
Humidity:	20 to 60 percent relative humidity (RH) noncondensing
Pressure:	Normal ground or aircraft operating altitude pressures. For very high altitudes, tape users should consult with manufacturers to determine if tape and recorder compatibility is affected by low atmospheric pressure.



- (1) Binder/oxide system tends to become sticky and unusable above 50 °C (125 °F).
- (2) At low humidities, tape binder and oxide system tends to dry out, and oxide and binder adhesion can be unsatisfactory. Brown stains on heads may appear below 40 percent RH.
- (3) At high humidities, abrasivity is increased and other performance problems may arise.

7.4.2.3 Non-operating Environment. Temperature and Relative Humidity.

Short Term: 0 to 45 °C (32 to 115 °F) and 10 to 70 percent RH noncondensing

Long Term: 1 to 30 °C (33 to 85 °F) and 30 to 60 percent RH noncondensing



Experience has shown that with long exposure to temperatures below freezing, lubricants and plasticizers tend to migrate out of the oxide coating resulting in poor lubrication and gummy surface deposits.

7.4.3 Other Characteristics. Storage life, bi-directional performance, frictional vibration, and scatterwind characteristics shall conform to Federal Specification W-T-1553[SH] unless otherwise specified by the tape user at the time of purchase.

**7.5 Physical Characteristics of Instrumentation Tapes and Reels**

As specified in Federal Specifications W-T-1553B, W-T-1553/1-4 and W-R-175.

**7.6 Instrumentation Tape Magnetic and Electrical Characteristics**

The following subparagraphs describe required magnetic and electrical tape characteristics.

7.6.1 Bias Level. The bias level (see subparagraph [7.2.3](#)) required by the magnetic tape shall not differ from the bias level requirements of the reference tape by more than the amount specified by the tape user. The test procedure outlined in subparagraph 5.3.8.1, Bias Level, Volume III of RCC Document 118 shall be used to determine compliance with this requirement.

7.6.2 Record Level. The record level (see subparagraph [7.2.20](#)) required by the magnetic tape shall not differ from the record level requirements of the reference tape by more than the amount specified by the tape user. The test procedure outlined in subparagraph 5.3.8.2, Record Level, Volume III of RCC Document 118 shall be used to determine compliance with this requirement.

7.6.3 Wavelength Response. The output of the magnetic tape, measured at the wavelength values listed in Table [7-2](#), Measurement Wavelengths, shall not differ from the output of the reference tape by more than the amounts specified by the tape user. Wavelength response requirements shall be specified in terms of output after having normalized the output to zero decibels at the 0.1 UBE wavelength. The test procedure outlined in subparagraph 5.3.9 Wavelength Response and Output at 0.1 Upper Band Edge Wavelength, Volume III of RCC Document 118 shall be used to determine compliance with this requirement (see Table [7-4A](#), Suggested Wavelength Response Requirements).

TABLE 7-2. MEASUREMENT WAVELENGTHS			
High-Resolution and HDD Tape		High-Energy Tape	
( $\mu\text{m}$ )	(mils)	( $\mu\text{m}$ )	(mils)
3810.00	(150.000)	254.00	(10.000)
254.00	(10.000)	25.40	(1.000)
25.40	(1.000)	12.70	(0.500)
6.35	(0.250)	6.35	(0.250)
3.18	(0.125)	3.18	(0.125)
2.54	(0.100)	2.54	(0.100)
2.03	(0.080)	1.52	(0.060)
1.52	(0.060)	1.02	(0.040)
		0.76	(0.030)

7.6.4 Output at 0.1 UBE Wavelength. The wavelength output of the magnetic tape shall not differ from the 0.1 UBE wavelength of the reference tape by more than the amount specified by the tape user. The test procedure outlined in subparagraph 5.3.9, Wavelength Response and Output at 0.1 Upper Band Edge Wavelength, Volume III of RCC Document 118 shall be used to determine compliance with this requirement.

7.6.5 Short Wavelength Output Uniformity. The short wavelength output of the magnetic tape shall be sufficiently uniform that a signal recorded and reproduced throughout the working tape length in either direction of longitudinal tape motion shall remain free from long-term amplitude variation to the extent specified by the tape user. The test procedure outlined in subparagraph 5.3.10, Short Wavelength Output Uniformity, Volume III of RCC Document 118 shall be used to determine compliance with this requirement.

7.6.6 Dropouts. The instantaneous nonuniformity (dropout) output of a recorded signal, caused by the magnetic tape, shall not exceed the center-track and edge-track limits specified by the tape user on the basis of dropouts per 30.48 m (100 ft.) of nominal working tape length. The nominal dropout count shall be determined by totaling all the dropouts per track over the working tape length and dividing by the total number of 30.48 m (100 ft.) intervals tested.

A second method of specifying the allowable dropout count is to specify the maximum number per track for each 30.48 m (100 ft.) interval tested. This method may be preferred if critical data is recorded in specific areas of the working tape length, but a specified number of dropouts per hundred feet greater than the average values may be expected.



Dropout test results are very dependent on the tape transport used for the test and will vary from run to run on a given transport. Edge tracks tend to contain more dropouts than the center tracks, and more dropouts are allowed on the edge tracks. Refer to Table [7-4](#).

7.6.6.1 For High Resolution (HR) tapes, a dropout is defined as a 6 dB reduction in amplitude for a period of 5 microseconds or more of a 1 MHz sine-wave signal recorded and reproduced at a tape speed of 3048 mm/s (120 ). Signal losses of 6 dB or more which exceed the 5 microsecond time period shall constitute a dropout count for each 5 microsecond time period occurring in the given signal loss. Track definitions are given in subparagraphs [7.2.7](#) and [7.2.9](#). The test procedure outlined in subparagraph 5.3.11, Volume III of RCC Document 118 shall be used to determine compliance with this requirement.

7.6.6.2 For High Density Digital (HDD) tapes, a dropout is defined as a 10 dB or greater reduction in amplitude for a period of 1 microsecond or more of a square-wave test signal of maximum density recorded and reproduced at 3048 mm/s or 1524 mm/s (120 in/s or 60 in/s). On at least every other track (7 tracks of the odd head on a 28-track head assembly (alternatively, every other track of the even head) record and reproduce a square-wave test signal of 2 MHz at

3048 mm/s (120 in/s) or 1 MHz at 1524 mm/s (60 in./s). The record level shall be set slightly above saturation by adjusting the record current to produce maximum reproduce output and increasing the record current until the output signal is reduced to 90 percent of maximum. For playback, a reproduce amplifier and a threshold detector shall be used. The signal-to-noise ratio of the test signal at the input to the threshold detector shall be at least 25 dB, and the detector shall detect any signal loss of 10 dB or more below reference level. The reference level shall be established by averaging the test signal output level over a 10 m (30.8 ft.) nominal tape length in the vicinity of a dropout.

7.6.6.3 For each of the seven tracks tested, the accumulated duration in microseconds of detected dropout events shall be displayed and used to directly display the dropout rate for each track scaled appropriately for the tape working length. Signal losses of 10 dB or more which exceed the 1 microsecond time period shall constitute a dropout count for each microsecond time period occurring in the given signal loss.

7.6.6.4 For high-energy tapes, a dropout is defined as for high-resolution tapes except that a 2 MHz signal is used.

7.6.7 Durability. The magnetic tape shall resist deterioration in magnetic and electrical performance because of wear to the coating surface. Signal losses, as defined below, caused by surface wear shall not occur in excess of the per-pass limits specified in Table 7-3 for the first 35 passes.

Signal losses in excess of those limits specified above shall not occur during either a record, record and reproduce or uninterrupted reproduce pass of the working tape length. Signal loss is a reduction in signal amplitude of 3 dB or greater for a time period of 3 through 10 seconds of a recorded and reproduced short wavelength signal. Where a continuous loss of signal of 3 dB or greater exceeds the 10-second time period, a signal loss count shall be required for every sequential 10-second time period occurring in the given signal loss. The test procedure outlined in subparagraph 5.3.12, Durability, Volume III of RCC Document 118 shall be used to determine compliance with this requirement.

**TABLE 7-3. DURABILITY SIGNAL LOSSES**

Designated Tape Length		Number of Allowable Signal Losses (per pass)
meters	feet	
762	(2500)	2
1097	(3600)	2
1402	(4600)	2
1524	(5000)	2
2195	(7200)	3
2804	(9200)	3
3292	(10 800)	4

7.6.8 Modulation Noise. The amplitude modulation superimposed upon a recorded and reproduced signal by the magnetic tape shall not exceed the limits specified by the tape user. The test procedure outlined in subparagraph 5.3.13, Modulation Noise, Volume III of RCC Document 118 shall be used to determine compliance with this requirement.

7.6.9 Layer-to-Layer Signal Transfer. A signal resulting from layer-to-layer signal transfer shall be reduced in amplitude from the original signal a minimum of 40 dB for 25.4 Tm (1.0 mil) tape and 46 dB for 38.1 Tm (1.5 mils) tape. The test procedure outlined in subparagraph 5.3.14, Layer-to-Layer Signal Transfer, Volume III of RCC Document 118 shall be used to determine compliance with this requirement.

7.6.10 Erase Ease. For HR and HDDR tapes, an erase field of 79.58 kA/M (1000 oersteds) shall effect at least a 60 dB reduction in output amplitude of a previously recorded 25.4 μm (1.0 mil) wavelength signal. For HE tapes, an erase field of 160 kA/m (2000 oersteds) shall effect at least a 60 dB reduction of a previously recorded 25.4 Tm (1.0 mil) wavelength signal. The test procedure outlined in subparagraph 5.3.15, Ease of Erasure, volume III of RCC Document 118 shall be used to determine compliance with this requirement.

7.6.11 Suggested Tape Requirement Limits. Table 7-4 lists some suggested limits to be used for instrumentation tape.

<b>TABLE 7-4. SUGGESTED TAPE REQUIREMENT LIMITS</b>			
<b>Parag. No.</b>	<b>Tape Requirement</b>	<b>Suggested Limits</b>	
7.6.1	Bias Level	±2.0 dB from MCT	
7.6.2	Record Level	±2.0 dB from MCT	
7.6.3	Wavelength Response (See Table <a href="#">7-4A</a> .)		
7.6.4	Output at 0.1 UBE Wavelength	1.5 dB from MCT	
7.6.5	Short Wavelength Output Uniformity	<u>HR Tape</u> 2.5 dB	<u>HE Tape</u> 2.5 dB
7.6.6	Dropouts per 30 m (100 ft) (average)	<u>Center Tracks</u>	<u>Edge Tracks</u>
		5	<u>HR Tape</u> 10
		1	<u>HDD Tape</u> 1
		20	<u>HE Tape</u> 30
7.6.7	Durability (See Table <a href="#">7-3</a> .)		
7.6.8	Modulation Noise	1 dB maximum	

<b>TABLE 7-4A. SUGGESTED WAVELENGTH RESPONSE REQUIREMENTS</b>
<u>HR and HDD TAPE</u>

<u>Measurement Wavelength</u>		<u>HR Response</u>	<u>HDD Response</u>
( $\mu\text{m}$ )	(mils)	(dB)	(dB)
3810.00	(150.000)	1.00	2.00
254.00	(10.000)	1.00	1.00
15.14	(0.600)	0.00	0.00
6.35	(0.250)	1.50	1.50
3.18	(0.125)	2.00	2.00
2.54	(0.100)	2.50	2.50
2.03	(0.080)	2.50	2.50
1.52	(0.060)	3.00	3.00

HIGH-ENERGY TAPE

<u>Measurement Wavelength</u>		<u>HE Wavelength Response</u>
( $\mu\text{m}$ )	(mils)	(dB)
25.40	(1.000)	2.00
12.70	(0.500)	2.00
7.62	(0.300)	0.00
3.18	(0.125)	2.50
1.52	(0.060)	2.50
1.02	(0.040)	3.00
0.76	(0.030)	3.50



## **7.7 General Requirements for 19-mm Digital Cassette Helical Scan Recording Tape and Cassettes**

7.7.1 Magnetic Tape. The magnetic tape shall meet the requirements of MML 94-1, *Specification for Rotary Instrumentation Magnetic Recording Tape, 19-millimeter (0.75 inch) Wide, 68 KA/M (850 oersteds)*.<sup>23</sup>

7.7.2 19-mm Cassettes. The recorder/reproducers shall be capable of using 19 mm cassettes that conform to the physical dimensions of medium and large cassettes as defined in SMPTE 226M.<sup>24</sup>

## **7.8 General Requirements for 1/2-Inch Digital Cassette Helical Scan Recording Tape and Cassettes**

7.8.1 Magnetic Tape. The magnetic tape shall meet the requirements of MML Document 93-1, *Specification for Rotary Instrumentation Magnetic Recording Tape, 12.65 millimeter (0.5 inch), 68 KA/M (850 oersteds)*.<sup>25</sup>

7.8.2 1/2-Inch Cassettes. The recorder/reproducers shall be capable of using 1/2-inch cassettes that conform to the physical dimensions as defined in SMPTE 32M (1998), *Video Recording – 1/2 in. Type H – Tape and Records*.<sup>26</sup> To ensure crossplay compatibility, the T-160 (327 meters, min.) is recommended.

---

<sup>23</sup> MML Document 94-1 is available from the Naval Air Warfare Center Aircraft Division, Warminster, Pennsylvania 18974-0591.

<sup>24</sup> SMPTE 226M is available from the Society of Motion Picture and Tele-vision Engineers, 595 West Hartdale Avenue, White Plains, New York 10607.

<sup>25</sup> MML Document 93-1 is available from the Naval Air Warfare Center, Aircraft Division, Warminster, Pennsylvania 18974-0591.

<sup>26</sup> Formerly ANSI V98.33M-1983.

This page intentionally left blank.

## CHAPTER 8

### MIL-STD-1553 ACQUISITION FORMATTING STANDARD

#### 8.1 General

This standard addresses the acquisition of all the traffic flowing on MIL-STD-1553 type data buses. The formats described permit up to eight data buses within a single system. Other constraints such as RF bandwidth and tape recording time will dictate the actual number of buses processed by a single system. Standards for both composite (telemetry) and tape recorder formats are presented.

Although specifically designed to satisfy the requirements of 100 percent MIL-STD-1553 bus acquisition, the formatting provisions of this standard may be used in other applications when the data source and content are similar enough to permit easy adaptation. Users should contact the appropriate range to ensure any adaptations are compatible with that range.

#### 8.2 Definitions

8.2.1 Bus Monitor. The terminal assigned the task of receiving bus traffic and extracting all information to be used at a later time.

8.2.2 Data Bus. All hardware including twisted shielded pair cables, isolation resistors, and transformers required to provide a single data path between the bus controller and all the associated remote terminals.

8.2.3 Dual Redundant Data Bus. The use of two data buses to provide multiple paths between the subsystems.

8.2.4 Bus Loading. The percentage of time the data bus is active.

8.2.5 Maximum Burst Length. The maximum length of a continuous burst of messages with minimum length message gaps.

8.2.6 Bus Error. Conditions detected which violate the definition of MIL-STD-1553 word structure. Conditions such as synchronization, Manchester, parity, noncontiguous data word, and bit count/word errors are all considered word type errors. System protocol errors, for example, incorrect word count/message and illegal mode codes, are not considered bus errors.

### 8.3 Source Signal

The source of data is a signal conforming to MIL-STD-1553. Format provisions are made for a dual redundant data bus system per bus. The interface device performing the data acquisition shall be configured as a bus monitor. Figure 8-1 depicts in block diagram form the concept of 100 percent MIL-STD-1553 bus data acquisition.



In the design of the interface to the MIL-STD-1553 bus, it may be necessary to include buffers to prevent loss of data and to conserve bandwidth. The buffer size is influenced by bus loading, maximum burst length, output bit rate, tape recording speed, time tagging, and auxiliary inputs.

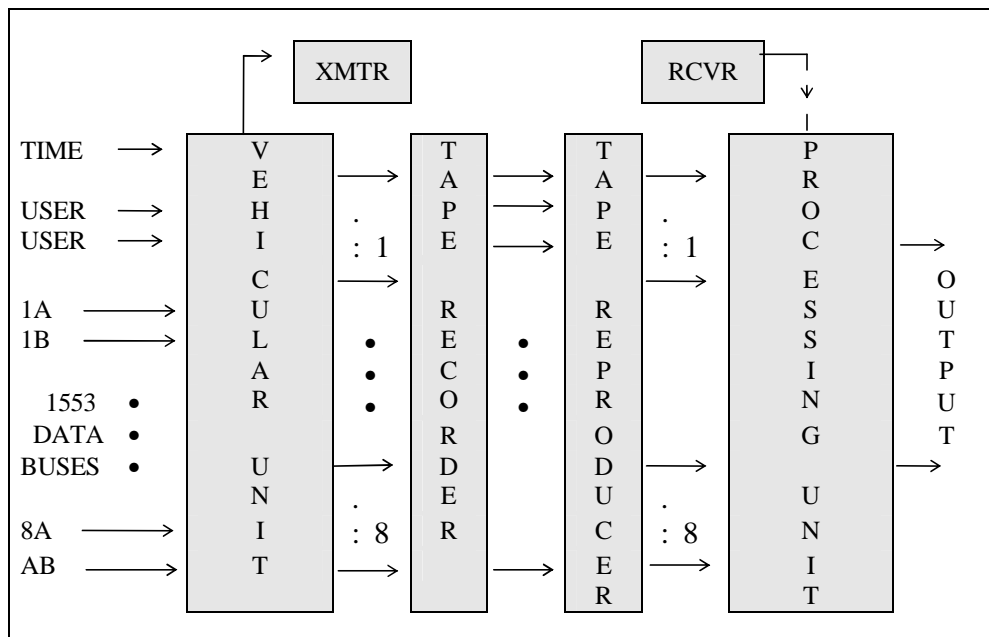

Figure 8-1. System block diagram.

## 8.4 Word Structure

The following subparagraphs describe the general word structure to be used for the formatted output.

8.4.1 The formatted data shall be a 24-bit word constructed as shown in Figure [8-2\(a\)](#).

8.4.2 The information extracted from the data bus shall have the synchronization pattern and parity bit removed.

8.4.3 Each incoming MIL-STD-1553 word (Command, Status or Data), auxiliary input or time word shall be appropriately labeled with a 4-bit content identifier label as described in Figure [8-2\(c\)](#).

8.4.4 Data extracted from the MIL-STD-1553 bus shall maintain bit order integrity in the information field for a command, status, data, and error word. Bit position four in the MIL-STD-1553 bus word shall be placed in bit position nine in the formatted data word. The remaining bits of the MIL-STD-1553 bus word shall be placed in successive bit positions in the formatted data word. Transposing or reordering of the bits is not permitted.

8.4.5 Each word shall also carry a 3-bit bus identifier label as shown in Figure [8-2\(b\)](#).

8.4.6 An odd-parity bit generated for the resulting formatted data shall be the most significant bit as shown in Figure [8-2\(a\)](#).

8.4.7 Fill words, required to maintain continuous data output, shall have 1010 1010 1010 1010 (AAAA hex) as the information bit pattern.

8.4.8 For bus errors defined in paragraph [8.2.6](#) (Error A - 1100 or Error B - 1000), the synchronization pattern and the parity bit are removed as stated in subparagraph [8.4.2](#). The information bits, 9 through 24, of the formatted word shall contain the resulting 16-bit pattern extracted from the bus.

8.4.9 The buffer overflow tag (0000) and appropriate bus identification tag shall be appended to the first word placed into the buffer after the buffer becomes available for data storage. This word should be an "extra" word, not the next available piece of data. Bits 9 through 24 are available for system level diagnostics and are not specified here. Tagging in this manner marks the point of data discontinuity and preserves the integrity of the next piece of data.

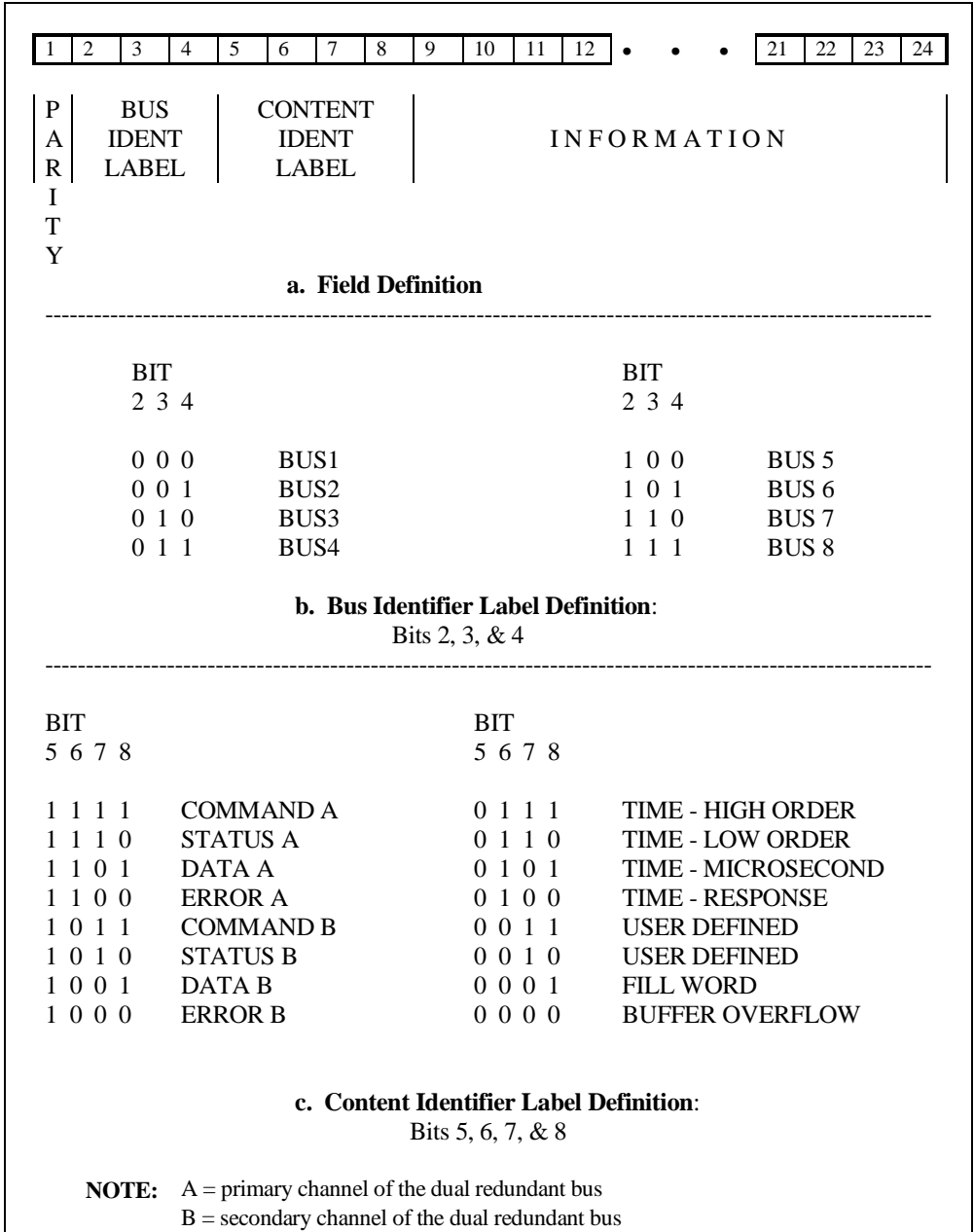

Figure 8-2. Word construction.

## 8.5 Time Words

The following subparagraphs describe the structure and use of time words within the formatted output.

8.5.1 There shall be four words dedicated to providing timing information. Three of these words are defined in subparagraphs [4.7.1](#) through [4.7.4](#) and Figure [4-3](#). They are designated as high order time, low order time, and microsecond time. The optional, fourth-time word, designated-response time, has the same structure as the microsecond time word (subparagraph [4.7.2](#)). The structure shall follow the 16-bit per word format shown in Figure 4-3 and be placed into bits 9 through 24.

8.5.2 If time tagging of the occurrence of MIL-STD-1553 messages is necessary to satisfy user requirements, the first command word of the message shall be time tagged. The time words shall immediately follow the first command word in the following order: high order time, low order time, and microsecond time.

8.5.3 The optional response time word shall have 1 microsecond resolution and shall indicate the response time of the data bus. The response time word shall immediately precede the status word associated with it.



If the response time function is not used, the identifier label 0100 may be assigned to user defined inputs.

## 8.6 Composite Output

The following subparagraphs describe the characteristics for a singular composite output signal.

8.6.1 The composite, continuous output shall conform to the requirements for pulse-code modulation as stated in Chapter 4.

8.6.2 The data shall be transmitted or recorded most significant bit first.

8.6.3 The bit rate is dependent on several factors including bus loading and auxiliary inputs and shall be sufficient to preclude any loss of data.

8.6.4 The order of bus words must remain unaltered except in the case of a buffer overflow.

8.6.5 The frame length shall be fixed using fill words as required and shall be  $\geq 128$  words and  $\leq 256$  words including the frame synchronization word.

8.6.6 The frame synchronization word shall be fixed and 24 consecutive bits in length. The pattern, also shown in Table [C-1](#), Appendix C, is 1111 1010 1111 0011 0010 0000 (FAF320 hex).

8.6.7 A frame structure employing frame time is recommended but optional. If frame time is used, the frame structure shall consist of the frame synchronization word, followed by the high order time word, followed by the low order time word, followed by the microsecond time word, followed by the data words from all sources making up the composite signal up to the frame length specified in subparagraph [8.6.6](#) (see Figure [8-3](#)). If frame time is not used, the frame synchronization word shall be followed immediately by the data words.



Additional care must be exercised in data processing and reduction if the last word in a composite stream is a command word. The associated message time tag will not appear until after the synchronization and time words in the next frame.

8.6.8 The following subparagraphs describe the recommended techniques for recording the high bit rate composite output signal.

8.6.8.1 Longitudinal recording shall conform to the PCM recording provisions of Chapter 6.

8.6.8.2 Recording using parallel HDDR or rotary head recorders offers the advantage of inputting a single high bit rate signal to the recording system. The input PCM signal shall conform to the appropriate sections of this standard.

8.6.8.3 If recording using digital recorders or other noncontinuous recording processes with buffered inputs, the fill words, inserted to provide a continuous output stream, may be optionally eliminated.

## **8.7 Single Bus Track Spread Recording Format**

The following subparagraphs describe the characteristics of a single bus recording technique using a multiple tape track spread output format.

8.7.1 The target tape recorder/reproducer for a track spread format is a longitudinal fixed-head machine described in Chapter 6 and not one employing parallel high density digital recording (HDDR) or rotary head recording characteristics.



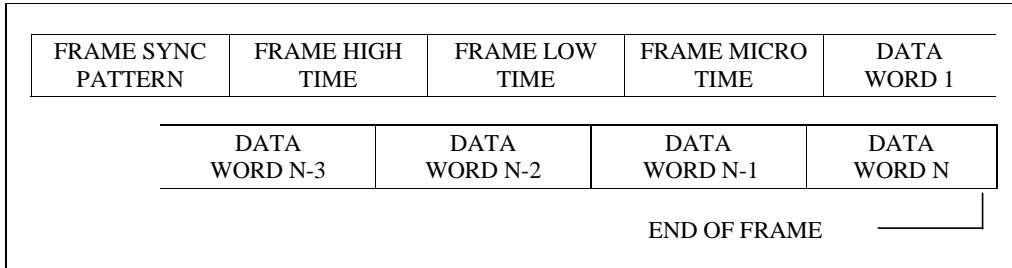



Figure 8-3. Composite frame structure.

8.7.2 The code generated for longitudinal tape recording shall be RNRZ-L or Biφ-L as described in Chapters 4 and 6.

 <p><b>NOTE</b></p>	<p>Bit rates less than 200 000 bits per second are not recommended when using RNRZ-L.</p>
---	---

8.7.3 To extend recording time while still acquiring 100 percent of the MIL-STD-1553 bus data, a multiple track spread recording technique is presented.

8.7.3.1 When necessary to use more than one tape recording track (to extend record time), separate PCM streams shall be created and delayed by 24/TK bits with respect to each other, where TK represents the number of tape tracks used for a given bus.

8.7.3.2 When multiple track spread recording is required, the track spread shall be on a bus basis such as bus number 1 spread over four tracks, and bus number 2 spread over two tracks. The maximum number of tracks per bus shall be limited to four.

 <p><b>NOTE</b></p>	<p>Consideration should be given to spread track assignment; that is, all tracks associated with a given bus should be recorded on the same head stack.</p>
--	---

8.7.3.3 Each stream shall have a frame synchronization pattern 24 bits in length, conforming to subparagraph [8.6.6](#).

8.7.3.4 The word structure shall be identical to that described in paragraph 8.4.

8.7.3.5 The frame length shall be fixed and shall be the same for each track used for a given bus. The frame length shall conform to the requirements of subparagraph 8.6.5.

8.7.3.6 The data shall be formatted such that it is transmitted (recorded) most significant bit first.

8.7.3.7 A structure employing frame time is recommended but optional. This subparagraph describes a four-track spread example using frame time. The PCM stream designated TK1 shall be constructed as the frame synchronization word, followed by the high order frame time word, followed by data words (see Figure 8-4). The PCM stream designated TK2 shall be constructed as the frame synchronization word, followed by the low order frame time word, followed by data words. The PCM stream designated TK3 shall be constructed as the frame synchronization word, followed by the microsecond frame time word, followed by data words. The PCM stream designated TK4 shall be constructed as the frame synchronization word, followed by the first data word, followed by other data words. Schemes using one, two, or three tracks for a given bus shall follow like construction; that is, sequencing through the data track by track. If frame time is not used, data words shall immediately follow the frame synchronization patterns.



Additional care must be exercised in data processing and reduction if the last word in the final track spread stream is a command word. The associated message time tag will not appear until after the synchronization and time words in the next frame.

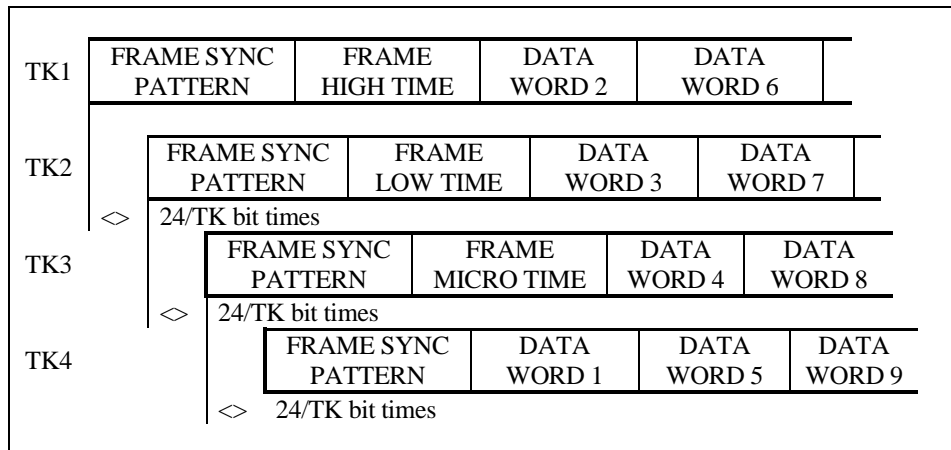

Figure 8-4. Multiple tape track spread format (4-track spread example).



## CHAPTER 9

### TELEMETRY ATTRIBUTES TRANSFER STANDARD

#### 9.1 General

Telemetry attributes are those parameters required by the receiving/processing system to acquire, process, and display the telemetry data received from the test item/source. The Telemetry Attributes Transfer Standard (TMATS) provides a common definition and format to facilitate the transfer of information between the user and the test range and between ranges. The telemetry attributes are defined such that the information required to set up the telemetry receiving and processing equipment is provided. The format, while not necessarily compatible with any receiving/processing system, will allow test ranges or other receiving systems to develop a computer conversion program to extract the information and to set up data required for their unique equipment configuration. Nonstandard parameter variations are not included in the attribute listings of choices but may be included by exception in the comments section of each group.

The intent of this chapter is to cover primarily attributes and terminology included in or consistent with the other chapters in document 106. For example, PCM format attributes should comply with the PCM standards as given in Chapter 4. Other attributes are included, at times, for service and utility, but should not be construed as endorsements apart from the other 106 chapters.

#### 9.2 Scope

The TMATS provides the definition of the telemetry attributes and specifies the media and data format necessary to permit the ready transfer of the information required to set up the telemetry receiving/processing functions at a test range. The standard does not conform to nor does it define existing or planned capabilities of any given test range. Only those parameters that are defined in this document are included by specific reference. Other nonstandard parameter values/definitions may be included in the comments section of each group.

#### 9.3 Purpose

The TMATS provides a common format for the transfer of information between the user and a test range or between ranges (see Appendix H). This format will minimize the "station unique" activities that are necessary to support any test item. In addition, it is intended to relieve the labor intensive process required to reformat the information by providing the information on computer compatible media, thus reducing errors and requiring less preparation time for test support.

## 9.4 Media and Data Structure

A variety of physical and electronic media are available for use in exchanging attribute information. The most important factor in selecting which medium to use is that the parties involved must agree to the specific medium of choice. If any data compression (such as Backup/Restore or Zip/Unzip) will be used, both parties should agree to its use.

A cover sheet describing the system that produced the attribute medium should accompany the attribute information. A recommended format for the cover sheet is given in Appendix I.

**9.4.1 Physical Format.** Attributes for each mission configuration are to be supplied in a single physical file with contents as 7-bit ASCII coded characters. Line feed (LF) and carriage return (CR) may be used to improve readability of the information. Nonprintable characters will be discarded by the destination agency prior to translating the attributes into telemetry system configuration information.

For disks, multiple mission configurations may be provided on a single disk; however, each configuration must be in a separate file identified in the disk directory. File names should use the file extensions '.TXT' to indicate a text file, or '.TMT' or '.TMA' to indicate a TMATS file. A stick-on label and the accompanying cover sheet identify the file names corresponding to the mission configuration used for each mission.

On magnetic tape, physical records may be any size up to 2048 bytes. A single end-of-file (EOF) mark indicates the end of a mission configuration. Additional mission configurations can be included in sequential files on a single tape. A double EOF is used to indicate the end of the last mission configuration on the tape. A stick-on label and an accompanying cover sheet identifying the missions for each configuration are required.

**9.4.2 Logical Format.** Each attribute appears in the file as a unique code name and as a data item. The code name appears first, delimited by a colon. The data item follows, delimited by a semicolon. Thus, an attribute is formatted as A:B; - where A is the code name and B is the data item, in accordance with the tables in paragraph 9.5. Numeric values for data items may be either integer or decimal. Scientific notation ( $\pm d.dddddE\pm ee$ ) is allowed only for the specific data items defined for its use in the tables in paragraph 9.5. For alphanumeric data items, including keywords, either upper or lower case is allowed; all defined keyword values are shown as upper case and enclosed in quotes in the tables in paragraph 9.5. Semicolons are not allowed in any data item (including comment items). Any number of attributes may be supplied within a physical record subject to the maximum mentioned in subparagraph 9.4.1. Attributes may appear in any order.

There are two basic types of attribute code names: single and multiple entry. Single-entry attributes are those for which there is only one data item. Multiple-entry attributes appear once in the definition tables in paragraph 9.5 but have multiple items; these items are assigned a number. The number appears in the code name preceded by a hyphen. For example, data source identifiers might have the following entries:

G\DSI-1:Aircraft;  
G\DSI-2:Missile;  
G\DSI-3:Target;

The code name COMMENT may be used to interject comments to improve readability. (Note that the comment data items, such as G\COM, are intended to convey further details within the TMATS file itself.) Comments must follow the attribute logical format, as shown below:

COMMENT: This is an example of a comment;

Refer to paragraph 9.5 for detailed definitions of code names and attributes and Appendix J for an example application of this standard.

## 9.5 Telemetry Attributes

The description of the mission configuration includes all potential sources of data: RF links, pre- or post-detected tapes, or onboard-recorded tapes or storage media. Each of these has unique characteristics which must be defined. Each source is given a unique identity and its characteristics are specifically defined in associated attributes fields. In multiplexed systems, each data stream is uniquely identified by a data link name, which, in turn, is related to the data source name.



Only the information that is essential to define the attributes of a system is required. Nonapplicable information does not need to be included in the file. However, all attribute information given is to be provided in the specified format.

The attributes defined in this section proceed from the general level to the detailed level. The groups defined, in terms of data to be entered, are described next.

General Information - establishes the top-level program definition and identifies the data sources.

Transmission Attributes - define an RF link. There will be one group for each RF link identified in the General Information Group.

Tape/Storage Source Attributes - identify a tape or storage data source.

Multiplex/Modulation Attributes - describe the FM/FM, FM/PM, or PM/PM multiplex characteristics. Each multiplexed waveform must have a unique set of attributes. For the analog measurement, the tie to the engineering units conversion is made in this group.

Digital Data Attributes - are divided into three groups: the PCM Format Attributes, the PCM Measurement Description, and the Bus Data Attributes.

PCM Format Attributes - define the PCM data format characteristics, including subframes and embedded formats. Each PCM format will have a separate format attributes group.

PCM Measurement Descriptions - define each PCM measurand that ties the PCM measurement, format, and data conversion (calibration) together.

Bus Data Attributes - specify the PCM encoded MIL-STD-1553 or ARINC 429 bus format characteristics.

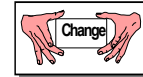

PAM Attributes - contain the definition of the PAM system. It includes the PAM format characteristics and measurement attributes. The tie to the engineering unit conversion is made for the measurands contained in the PAM format.

Data Conversion Attributes - contain the data conversion information for all measurements in this telemetry system. The calibration data and conversion definition of raw telemetry data to engineering units is included. The tie to the measurands of the telemetry systems defined in the previous groups is via the measurement name.

Airborne Hardware Attributes - define the configuration of airborne instrumentation hardware in use on the test item.

Vendor Specific Attributes - provide information that is specific to a vendor.

9.5.1 Contents. The following subparagraphs discuss the organization of the attributes and their relationships with the various groups.

9.5.1.1 Organization. Attribute information is organized according to a hierarchical structure in which related items are grouped and given a common heading. The number of levels varies within the overall structure and is a function of the logical association of the attributes. At the highest level, the telemetry attributes are defined for the following groups:

Identifier	Title
G	General Information
T	Transmission Attributes
R	Tape/Storage Source Attributes
M	Multiplexing/Modulation Attributes
P	PCM Format Attributes
D	PCM Measurement Description
B	Bus Data Attributes
A	PAM Attributes
C	Data Conversion Attributes
H	Airborne Hardware Attributes
V	Vendor Specific Attributes

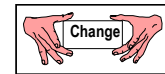

Within the structure, a lower case letter, for example, n, p, or r, indicates a multiple entry item with the index being the lower case letter. The range of these counters is from one to the number indicated in another data entry, usually with the appendage \N.

Within the tables, the code name, definition, and maximum field size are given for each individual attribute. The maximum field size is intended to be a guideline indicating the intended use of the attribute, and does not imply support of the maximum by any and all ranges. For example, the fact that the Number of Data Sources attribute is 2 characters long does not mean that 99 data sources are supported. Each range should be consulted as to their specific capabilities.

9.5.1.2 Group Relationships. The interrelationships between the various groups are shown pictorially in Figure [9-1](#).



1. Data Source ID is unique within a General Information Group (G). It ties the Transmission Group (T) or the Tape/Storage Group (R) or both to the G group and to the Multiplex/Modulation Group (M).
2. The tie from the M group to a PCM Group (P), a PAM Group (A), or a Bus Group (B) is the Data Link Name.
3. The tie from the P group to an embedded P group is another Data Link Name.
4. The tie from the M group to the Data Conversion Group (C) for an analog measurement is the Measurement Name.
5. The tie from the P group to the PCM Measurement Description Group (D) is the Data Link Name.
6. The tie from either the A, D, or B group to the Data Conversion



In the 106-04 revision to this chapter, the text, tables, and figures have been updated to include references to storage devices and media, in addition to tape media.

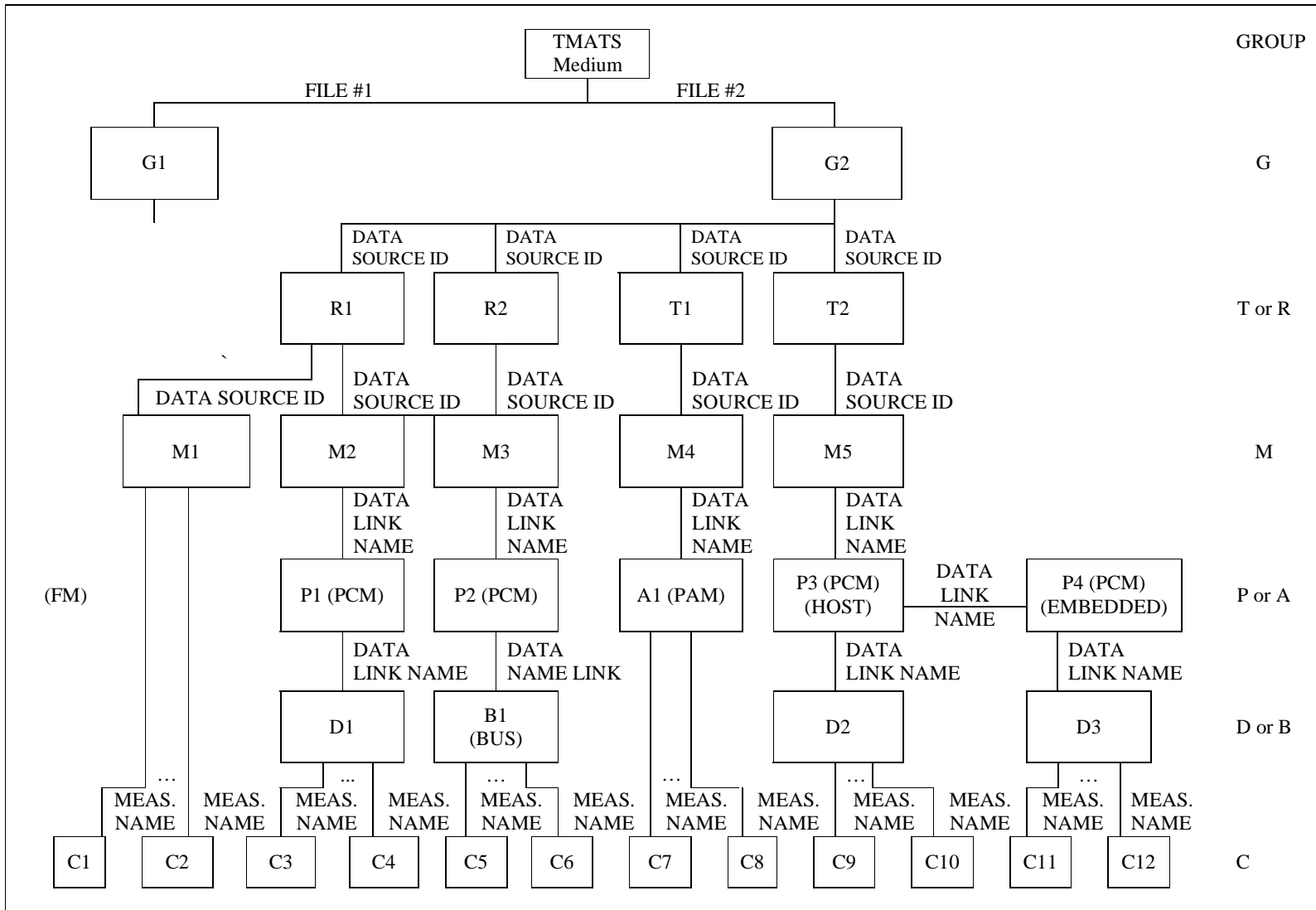

Figure 9-1. Group relationships.



9.5.2 General Information (G). The General Information Group provides overall program information. Figure 9-2 gives the overall information that is included in this group and Table 9-1 identifies and defines the data required including the dates associated with the detailed information. Since the identification of the data sources is an integral part of the remaining groups, each source must be identified uniquely.

<b>General Information Group (G)</b>		CODE NAME	REFERENCE PAGE
PROGRAM NAME		(G\PN)	(9-8)
TEST ITEM		(G\TA)	(9-8)
*INFORMATION			
	IRIG 106 REVISION LEVEL	(G\106)	
	ORIGINATION DATE	(G\OD)	
	REVISION NUMBER	(G\RN)	
	REVISION DATE	(G\RD)	
	UPDATE NUMBER	(G\UN)	
	UPDATE DATE	(G\UD)	
	TEST NUMBER	(G\TN)	
	NUMBER OF POINTS OF CONTACT	(G\POC\N)	
	*POINT OF CONTACT		
	NAME	(G\POC1-n)	
	AGENCY	(G\POC2-n)	
	ADDRESS	(G\POC3-n)	
	TELEPHONE	(G\POC4-n)	
	*DATA SOURCE IDENTIFICATION		(9-9)
	NUMBER OF DATA SOURCES	(G\DSI\N)	
	DATA SOURCE ID	(G\DSI-n)	
	DATA SOURCE TYPE	(G\DST-n)	
	*TEST INFORMATION		(9-9)
	TEST DURATION	(G\TI1)	
	PRE-TEST REQUIREMENT	(G\TI2)	
	POST-TEST REQUIREMENT	(G\TI3)	
	SECURITY CLASSIFICATION	(G\SC)	
	* COMMENTS		
	COMMENTS	(G\COM)	(9-10)

**\*Heading Only - No Data Entry**

Figure 9-2. General Information Group (G).

**TABLE 9-1. GENERAL INFORMATION GROUP (G)**

<b>PARAMETER</b>	<b>MAXIMUM FIELD SIZE</b>	<b>CODE NAME</b>	<b>DEFINITION</b>
PROGRAM NAME	16	G\PN	NAME OF PROGRAM
TEST ITEM	64	G\TA	TEST ITEM DESCRIPTION IN TERMS OF NAME, MODEL, PLATFORM, OR IDENTIFICATION CODE, AS APPROPRIATE
<b>INFORMATION</b>			
IRIG 106 REVISION LEVEL	2	G\106	VERSION OF IRIG 106 STANDARD USED TO GENERATE THIS TMATS FILE
ORIGINATION DATE	10	G\OD	DATE OF ORIGINATION OF THIS MISSION CONFIGURATION. DD - DAY           MM - MONTH YYYY - YEAR   (MM-DD-YYYY)
REVISION NUMBER	4	G\RN	REVISION NUMBER ASSOCIATED WITH THIS MISSION CONFIGURATION
REVISION DATE	10	G\RD	DATE OF REVISION. DD - DAY           MM - MONTH YYYY - YEAR   (MM-DD-YYYY)
UPDATE NUMBER	2	G\UN	UPDATE NUMBER OF CURRENT CHANGE WHICH HAS NOT BEEN INCORPORATED AS A REVISION
UPDATE DATE	10	G\UD	DATE OF UPDATE. DD - DAY           MM - MONTH YYYY - YEAR   (MM-DD-YYYY)
TEST NUMBER	16	G\TN	TEST IDENTIFICATION
NUMBER OF POINTS OF CONTACT	1	G\POC\N	NUMBER OF POINTS OF CONTACT TO BE GIVEN

**TABLE 9-1 (Cont'd). GENERAL INFORMATION GROUP (G)**

PARAMETER	MAXIMUM FIELD SIZE	CODE NAME	DEFINITION
POINT OF CONTACT: NAME AGENCY ADDRESS TELEPHONE	24 48 48 20	G\POC1-n G\POC2-n G\POC3-n G\POC4-n	LIST EACH OF THE RESPONSIBLE AGENCIES AND THEIR POINT OF CONTACT.
<b>DATA SOURCE IDENTIFICATION</b>			
NUMBER OF DATA SOURCES	2	G\DSI\N	SPECIFY THE NUMBER OF DATA SOURCES: FOR RF TELEMETRY SYSTEMS, GIVE THE NUMBER OF CARRIERS; FOR TAPE OR STORAGE RECORDED DATA, IDENTIFY THE NUMBER OF TAPE OR STORAGE SOURCES.
DATA SOURCE ID	32	G\DSI-n	PROVIDE A DESCRIPTIVE NAME FOR THIS SOURCE. EACH SOURCE IDENTIFIER MUST BE UNIQUE.
DATA SOURCE TYPE	3	G\DST-n	SPECIFY THE TYPE OF SOURCE: RF - 'RF'                      TAPE - 'TAP' STORAGE - 'STO'          OTHER - 'OTH'
<b>NOTE:</b> PROVIDE THE ABOVE TWO ITEMS FOR EACH DATA SOURCE.			
<b>TEST INFORMATION</b>			
TEST DURATION	4	G\TI1	APPROXIMATE DURATION OF TEST IN HOURS.
PRE-TEST REQUIREMENT	1	G\TI2	INDICATE WHETHER A PRE-TEST REQUIREMENT IS APPLICABLE ('Y' OR 'N'). PROVIDE DETAILS IN COMMENTS RECORD.
POST-TEST REQUIREMENT	1	G\TI3	SPECIFY WHETHER A POST-TEST REQUIREMENT IS APPLICABLE ('Y' OR 'N'). PROVIDE DETAILS IN COMMENTS RECORD.

<b>TABLE 9-1 (Cont'd). GENERAL INFORMATION GROUP (G)</b>			
<b>PARAMETER</b>	<b>MAXIMUM FIELD SIZE</b>	<b>CODE NAME</b>	<b>DEFINITION</b>
SECURITY CLASSIFICATION	1	G\SC	PROVIDE THE CLASSIFICATION OF THE PROJECT DATA. PROVIDE A DESCRIPTION OF THE CLASSIFICATION GUIDE AND ANY INFORMATION CONCERNING DECLASSIFICATION AND/OR DOWNGRADING IN COMMENTS RECORD. UNCLASSIFIED - 'U' CONFIDENTIAL - 'C' SECRET - 'S' TOP SECRET - 'T' OTHER - 'O'
<b>COMMENTS</b>			
COMMENTS	1600	G\COM	PROVIDE THE ADDITIONAL INFORMATION REQUESTED OR ANY OTHER INFORMATION DESIRED.

9.5.3 Transmission Attributes (T). The Transmission Attributes are presented graphically in Figure 9-3 and specified in Table 9-2. The information contained within this group is used to set up the RF receiver through the detection and recovery of the baseband composite waveform. The format contains the information needed to configure the antenna and receiver subsystems.

Additional equipment inserted in a specific range configuration such as microwave or other relay is intended to be transparent to the user and is not described under Transmission Attributes.

Because the information is mutually exclusive, only the appropriate frequency modulation (FM) or phase modulation (PM) system data set is required for a link.

<b>Transmission Attributes Group (T)</b>		CODE NAME	REFERENCE PAGE
DATA SOURCE ID		(T-x\ID)	(9-12)
	*SOURCE RF ATTRIBUTES		
	TRANSMITTER ID	(T-x\TID)	
	FREQUENCY	(T-x\RF1)	
	RF BANDWIDTH	(T-x\RF2)	
	DATA BANDWIDTH	(T-x\RF3)	
	MODULATION TYPE	(T-x\RF4)	
	TOTAL CARRIER MODULATION	(T-x\RF5)	
	POWER (RADIATED)	(T-x\RF6)	
	NUMBER OF SUBCARRIERS	(T-x\SCO\N)	
	SUBCARRIER NUMBER	(T-x\SCO1-n)	
	MODULATION INDEX	(T-x\SCO2-n)	
	MODULATOR NON-LINEARITY	(T-x\RF7)	
	*PREMODULATION FILTER		(9-13)
	BANDWIDTH	(T-x\PMF1)	
	SLOPE	(T-x\PMF2)	
	TYPE	(T-x\PMF3)	
	*TRANSMIT ANTENNA		(9-13)
	TRANSMIT ANTENNA TYPE	(T-x\AN1)	
	TRANSMIT POLARIZATION	(T-x\AN2)	
	ANTENNA LOCATION	(T-x\AN3)	
	*ANTENNA PATTERNS		(9-14)
	DOCUMENT	(T-x\AP)	
	*POINT OF CONTACT		
	NAME	(T-x\AP\POC1)	
	AGENCY	(T-x\AP\POC2)	
	ADDRESS	(T-x\AP\POC3)	
	TELEPHONE	(T-x\AP\POC4)	
	*GROUND STATION ATTRIBUTES		(9-14)
	IF BANDWIDTH	(T-x\GST1)	
	BASEBAND COMPOSITE BANDWIDTH	(T-x\GST2)	
	*GAIN CONTROL		(9-14)
	AGC TIME CONSTANT	(T-x\GST3)	
	OR		
	MGC GAIN SET POINT	(T-x\GST4)	
	AFC/APC	(T-x\GST5)	
	TRACKING BANDWIDTH	(T-x\GST6)	
	POLARIZATION RECEPTION	(T-x\GST7)	(9-14)
	*FM SYSTEMS		(9-15)
	OR		
	DISCRIMINATOR BANDWIDTH	(T-x\FM1)	
	DISCRIMINATOR LINEARITY	(T-x\FM2)	
	*PM SYSTEMS		(9-15)
	PHASE LOCK LOOP BANDWIDTH	(T-x\PLL)	
	*COMMENTS		
	COMMENTS	(T-x\COM)	(9-15)

\* Heading Only – No Data Entry

Figure 9-3. Transmission Attributes Group (T).

<b>TABLE 9-2. TRANSMISSION ATTRIBUTES GROUP (T)</b>			
<b>PARAMETER</b>	<b>MAXIMUM FIELD SIZE</b>	<b>CODE NAME</b>	<b>DEFINITION</b>
DATA SOURCE ID	32	T-x\ID	DATA SOURCE ID CONSISTENT WITH GENERAL INFORMATION GROUP
<b>SOURCE RF ATTRIBUTES</b>			
TRANSMITTER ID	12	T-x\TID	TRANSMITTER IDENTIFICATION
FREQUENCY	6	T-x\RF1	CARRIER FREQUENCY, IN MHZ. IF PROGRAMMABLE, ENTER 'P', AND DEFINE IN COMMENTS RECORD.
RF BANDWIDTH	6	T-x\RF2	TOTAL RF BANDWIDTH (-60 dB) OF MODULATED SIGNAL, IN MHZ
DATA BANDWIDTH	6	T-x\RF3	COMPOSITE BASEBAND DATA BANDWIDTH (3 dB), IN kHz.
MODULATION TYPE	12	T-x\RF4	DEFINE THE MODULATION TYPE: 'FM' 'PM' 'BPSK' 'DPSK' 'QPSK' 'FQPSK-B' 'FQPSK-JR' 'SOQPSK-TG' 'MULTI-H CPM' 'OTHR'
TOTAL CARRIER MODULATION	6	T-x\RF5	FOR FM SYSTEM, DEFINE TOTAL CARRIER DEVIATION, PEAK-TO-PEAK, IN kHz. FOR PM SYSTEM, DEFINE TOTAL PHASE MODULATION, PEAK-TO-PEAK, IN RADIAN.
POWER (RADIATED)	4	T-x\RF6	TOTAL TRANSMITTED POWER WHEN MODULATED, IN WATTS
NUMBER OF SUBCARRIERS	2	T-x\SCO\N	NUMBER OF SUBCARRIERS IN THE COMPOSITE BASEBAND WAVEFORM, n. IF NONE, ENTER 'NO'.

**TABLE 9-2 (Cont'd). TRANSMISSION ATTRIBUTES GROUP (T)**

<b>PARAMETER</b>	<b>MAXIMUM FIELD SIZE</b>	<b>CODE NAME</b>	<b>DEFINITION</b>
SUBCARRIER NUMBER	5	T-x\ SCO1-n	GIVE THE IRIG CHANNEL NUMBER FOR THE SUBCARRIER. IF NONSTANDARD SUBCARRIER, ENTER 'NO', AND ENTER FREQUENCY IN THE COMMENTS SECTION WHERE n IS AN IDENTIFICATION TAG FOR THE SUBCARRIER.
MODULATION INDEX	4	T-x\ SCO2-n	SPECIFY THE MODULATION INDEX FOR EACH SUBCARRIER IN THE COMPOSITE WAVEFORM, AS APPROPRIATE.
MODULATOR NONLINEARITY	4	T-x\ RF7	MODULATOR NONLINEARITY, IN PERCENT
<b>PREMODULATION FILTER</b>			
BANDWIDTH	6	T-x\ PMF1	PRE-MODULATION COMPOSITE FILTER BANDWIDTH, 3 dB CUT-OFF FREQUENCY, IN kHz
SLOPE	2	T-x\ PMF2	PRE-MODULATION FILTER ASYMPTOTIC ROLL-OFF SLOPE, dB/OCTAVE
TYPE	2	T-x\ PMF3	SPECIFY THE FILTER TYPE: CONSTANT AMPLITUDE - 'CA' CONSTANT DELAY - 'CD' OTHER - 'OT'
<b>TRANSMIT ANTENNA</b>			
TRANSMIT ANTENNA TYPE	16	T-x\ AN1	TRANSMIT ANTENNA TYPE
TRANSMIT POLARIZATION	4	T-x\ AN2	TRANSMIT ANTENNA POLARIZATION. 'RHCP' 'LHCP' LINEAR - 'LIN'
ANTENNA LOCATION	16	T-x\ AN3	DESCRIBE THE ANTENNA LOCATION.

**TABLE 9-2 (Cont'd). TRANSMISSION ATTRIBUTES GROUP (T)**

<b>PARAMETER</b>	<b>MAXIMUM FIELD SIZE</b>	<b>CODE NAME</b>	<b>DEFINITION</b>
<b>ANTENNA PATTERNS</b>			
DOCUMENT	16	T-x\AP	IDENTIFY DOCUMENT HAVING ANTENNA PATTERNS.
POINT OF CONTACT:			IDENTIFY THE POINT OF CONTACT FOR ADDITIONAL INFORMATION.
NAME	24	T-x\ AP\POC1	
AGENCY	48	T-x\ AP\POC2	
ADDRESS	48	T-x\ AP\POC3	
TELEPHONE	20	T-x\ AP\POC4	
<b>GROUND STATION ATTRIBUTES</b>			
IF BANDWIDTH	6	T-x\GST1	DEFINE THE IF BANDWIDTH (3 dB) IN MHz.
BASEBAND COMPOSITE BANDWIDTH	6	T-x\GST2	DEFINE THE CUTOFF FREQUENCY (3 dB), OF THE OUTPUT FILTER, IN kHz.
<b>GAIN CONTROL</b>			
AGC TIME CONSTANT	4	T-x\GST3	SPECIFY THE AGC TIME CONSTANT DESIRED IN MILLISECONDS.
MGC GAIN SET POINT	6	T-x\GST4	PROVIDE THE MANUAL GAIN CONTROL SET POINT IN TERMS OF RECEIVED SIGNAL STRENGTH, dBm.
AFC/APC	3	T-x\GST5	SPECIFY AUTOMATIC FREQUENCY CONTROL ('AFC') OR AUTOMATIC PHASE CONTROL ('APC') OR NONE ('NON').
TRACKING BANDWIDTH	4	T-x\GST6	SPECIFY TRACKING LOOP BANDWIDTH, IN Hz.



**TABLE 9-2 (Cont'd). TRANSMISSION ATTRIBUTES GROUP (T)**

<b>PARAMETER</b>	<b>MAXIMUM FIELD SIZE</b>	<b>CODE NAME</b>	<b>DEFINITION</b>
POLARIZATION RECEPTION	5	T-x\GST7	SPECIFY POLARIZATION TO BE USED: RHCP - 'RHCP' LHCP - 'LHCP' BOTH - 'BOTH' BOTH WITH DIVERSITY COMBINING: PRE-DETECTION-'B&DPR' POST-DETECTION-'B&DPO' DIVERSITY COMBINING (ONLY): PRE-DETECTION-'PRE-D' POST-DETECTION-'POS-D' OTHER - 'OTHER', SPECIFY IN COMMENTS.
<b>FM SYSTEMS</b>			
DISCRIMINATOR BANDWIDTH	4	T-x\FM1	SPECIFY THE DISCRIMINATOR BANDWIDTH REQUIRED, IN MHz.
DISCRIMINATOR LINEARITY	4	T-x\FM2	SPECIFY THE REQUIRED LINEARITY OVER THE BANDWIDTH SPECIFIED.
<b>PM SYSTEMS</b>			
PHASE LOCK LOOP BANDWIDTH	4	T-x\PLL	SPECIFY THE PHASE LOCKED LOOP BANDWIDTH.
<b>COMMENTS</b>			
COMMENTS	1600	T-x\COM	PROVIDE THE ADDITIONAL INFORMATION REQUESTED OR ANY OTHER INFORMATION DESIRED.

9.5.4 Tape/Storage Source Attributes (R). This group describes the attributes required when the data source is a magnetic tape as specified in Chapter 6 or a data storage device as specified in Chapter 10. In the case of the tape data link identification, each data source must be identified. In some cases the data source identification may be identical, particularly when the same information has been received from different receiver sites, on different polarizations, or on different carriers for redundancy purposes. Some of the information requested will be available only from the recording site or the dubbing location.





Figure [9-4](#) indicates the information required. Various categories of information have been included. In the data section of the attributes, it will be necessary to repeat the items until all of the data sources have been defined, including the multiple tracks, which contain ground station data of interest. Table [9-3](#) defines the information required. Any nonstandard tape recordings will require explanation in the comments and may require supplemental definition.

<b><u>Tape/Storage Source Attributes Group (R)</u></b>		CODE NAME	REFERENCE PAGE
DATA SOURCE ID		(R-x\ID)	(9-19)
	TAPE/STORAGE ID	(R-x\RID)	(9-19)
	TAPE/STORAGE DESCRIPTION	(R-x\RI)	
	<b>*TAPE/STORAGE CHARACTERISTICS</b>		
	TAPE/STORAGE TYPE	(R-x\TC1)	
	TAPE/STORAGE MANUFACTURER	(R-x\TC2)	
	TAPE/STORAGE CODE	(R-x\TC3)	
	TAPE WIDTH	(R-x\TC4)	
	TAPE HOUSING	(R-x\TC5)	
	TYPE OF TRACKS	(R-x\TT)	
	NUMBER OF TRACKS/CHANNELS	(R-x\N)	
	RECORD SPEED	(R-x\TC6)	
	DATA PACKING DENSITY	(R-x\TC7)	
	TAPE REWOUND	(R-x\TC8)	
	<b>*RECORDER INFORMATION</b>		(9-20)
	TAPE DRIVE/STORAGE MANUFACTURER	(R-x\RI1)	
	TAPE DRIVE/STORAGE MODEL	(R-x\RI2)	
	ORIGINAL TAPE/STORAGE	(R-x\RI3)	
	DATE AND TIME CREATED	(R-x\RI4)	
	<b>*CREATING ORGANIZATION POINT OF CONTACT</b>		(9-20)
	NAME	(R-x\POC1)	
	AGENCY	(R-x\POC2)	
	ADDRESS	(R-x\POC3)	
	TELEPHONE	(R-x\POC4)	
	DATE OF DUB	(R-x\RI5)	
	<b>*DUBBING ORGANIZATION POINT OF CONTACT</b>		(9-21)
	NAME	(R-x\DPOC1)	
	AGENCY	(R-x\DPOC2)	
	ADDRESS	(R-x\DPOC3)	
	TELEPHONE	(R-x\DPOC4)	
	<b>*DATA</b>		(9-21)
	TRACK NUMBER/ CHANNEL ID	(R-x\TK1-n)	
	RECORDING TECHNIQUE	(R-x\TK2-n)	
	DATA SOURCE ID	(R-x\DSI-n)	
	DATA DIRECTION	(R-x\TK3-n)	
	CHANNEL ENABLE	(R-x\CHE-n)	
	CHANNEL DATA TYPE	(R-x\CDT-n)	
	<b>*DATA TYPE ATTRIBUTES</b>		(9-22)
	<b>*PCM DATA TYPE ATTRIBUTES</b>		
	DATA LINK NAME	(R-x\PDLN-n)	
	DATA PACKING OPTION	(R-x\PDP-n)	
OR	TYPE FORMAT	(R-x\PTF-n)	



(Continued on next page)

Figure 9-4. Tape/Storage Source Attributes Group (R).

	*BUS DATA TYPE ATTRIBUTES		(9-23)
	OR	DATA LINK NAME	(R-x\BDLN-n)
	*ANALOG DATA TYPE ATTRIBUTES		(9-23)
		NUMBER OF ANALOG CHANNELS/PKT	(R-x\ACH\N-n)
		DATA PACKING OPTION	(R-x\ADP-n)
		SAMPLE RATE	(R-x\ASR-n)
		MEASUREMENT NAME	(R-x\AMN-n-m)
		DATA LENGTH	(R-x\ADL-n-m)
		BIT MASK	(R-x\AMSK-n-m)
		MEASUREMENT TRANSFER ORDER	(R-x\AMTO-n-m)
OR	SAMPLE FACTOR	(R-x\ASF-n-m)	
	*DISCRETE DATA TYPE ATTRIBUTES		(9-24)
		DISCRETE MODE	(R-x\DMOD-n)
		SAMPLE RATE	(R-x\DSR-n)
		NUMBER OF DISCRETE MEASUREMENTS	(R-x\NDM\N-n)
		MEASUREMENT NAME	(R-x\DMN-n-m)
OR	MEASUREMENT TRANSFER ORDER	(R-x\DMTO-n-m)	
*VIDEO DATA TYPE ATTRIBUTES		(9-25)	
OR	VIDEO ENCODING DELAY	(R-x\VED-n)	
*TIME DATA TYPE ATTRIBUTES		(9-25)	
	TIME FORMAT	(R-x\TFMT-n)	
*REFERENCE TRACK		(9-25)	
	NUMBER OF REFERENCE TRACKS	(R-x\RT\N)	
	TRACK NUMBER	(R-x\RT1-n)	
	REFERENCE FREQUENCY	(R-x\RT2-n)	
*COMMENTS			
	COMMENTS	(R-x\COM)	(9-26)

\*Heading Only - No Data Entry

Figure 9-4 (Cont'd). Tape/Storage Source Attributes Group (R).

**TABLE 9-3. TAPE/STORAGE SOURCE ATTRIBUTES GROUP (R)**

<b>PARAMETER</b>	<b>MAXIMUM FIELD SIZE</b>	<b>CODE NAME</b>	<b>DEFINITION</b>
DATA SOURCE ID	32	R-x\ID	DATA SOURCE ID CONSISTENT WITH GENERAL INFORMATION GROUP
TAPE/STORAGE ID	32	R-x\RID	TAPE OR STORAGE IDENTIFICATION
TAPE/STORAGE DESCRIPTION	32	R-x\R1	TAPE REEL NUMBER OR OTHER DEFINITION, OR STORAGE DESCRIPTION
<b>TAPE/STORAGE CHARACTERISTICS</b>			
TAPE /STORAGE TYPE	4	R-x\TC1	SPECIFY THE TAPE OR STORAGE TYPE: ANALOG - 'ANAL' CASSETTE - 'CASS' HDDR - 'HDDR' PARALLEL - 'PARA' SOLID STATE RECORDER - 'SSR' OTHER - 'OTHR', DEFINE IN COMMENTS RECORD.
TAPE/STORAGE MANUFACTURER	8	R-x\TC2	NAME OF MANUFACTURER OF THE TAPE OR THE STORAGE MEDIA
TAPE/STORAGE CODE	8	R-x\TC3	SPECIFY MANUFACTURER'S TAPE OR STORAGE MEDIA DESIGNATION CODE.
TAPE WIDTH	4	R-x\TC4	PHYSICAL DIMENSION OF TAPE WIDTH, IN INCHES
TAPE HOUSING	5	R-x\TC5	STATE THE REEL SIZE, INCHES: '10.5' '14.0' '15.0' '16.0' 'OTHER' STATE THE CASSETTE SIZE, MM: '12.65' '19.0' 'OTHER'
TYPE OF TRACKS	2	R-x\TT	STATE THE TYPE OF TRACKS ON THE TAPE: LONGITUDINAL - 'LO' ROTARY - 'RO'
NUMBER OF TRACKS/ CHANNELS	2	R-x\N	STATE THE NUMBER OF TRACKS ON THE TAPE OR THE NUMBER OF CHANNELS ON THE STORAGE MEDIA.
RECORD SPEED	4	R-x\TC6	STATE RECORD SPEED (inches/second).

**TABLE 9-3 (Cont'd). TAPE/STORAGE SOURCE ATTRIBUTES GROUP (R)**

<b>PARAMETER</b>	<b>MAXIMUM FIELD SIZE</b>	<b>CODE NAME</b>	<b>DEFINITION</b>
DATA PACKING DENSITY	2	R-x\TC7	STATE RECORDING SYSTEM BANDWIDTH: INTERMEDIATE BAND - 'IM' WIDE BAND - 'WB' DOUBLE DENSITY - 'DD' OTHER - 'OT'
TAPE REWOUND	1	R-x\TC8	YES - 'Y'                      NO - 'N'
<b>RECORDER INFORMATION</b>			
TAPE DRIVE/STORAGE MANUFACTURER	8	R-x\RI1	NAME OF TAPE DRIVE OR STORAGE DEVICE MANUFACTURER
TAPE DRIVE/STORAGE MODEL	8	R-x\RI2	MANUFACTURER'S MODEL NUMBER OF TAPE DRIVE OR STORAGE DEVICE USED TO CREATE THE TAPE OR STORAGE MEDIA
ORIGINAL TAPE/STORAGE	1	R-x\RI3	YES - 'Y'                      NO - 'N'
DATE AND TIME CREATED	19	R-x\RI4	DATE AND TIME TAPE OR STORAGE MEDIA WAS CREATED: DD - DAY                      MM - MONTH YYYY - YEAR                HH - HOUR MI - MINUTE                SS - SECOND (MM-DD-YYYY-HH-MI-SS)
CREATING ORGANIZATION POC: NAME AGENCY ADDRESS TELEPHONE	24 48 48 20	R-x\POC1 R-x\POC2 R-x\POC3 R-x\POC4	POINT OF CONTACT AT THE FACILITY CREATING THE TAPE OR STORAGE MEDIA: NAME, AGENCY, ADDRESS, AND TELEPHONE
DATE OF DUB	10	R-x\RI5	DATE THE DUB WAS MADE: DD - DAY                      MM - MONTH YYYY - YEAR                (MM-DD-YYYY)

**TABLE 9-3 (Cont'd). TAPE/STORAGE SOURCE ATTRIBUTES GROUP (R)**

PARAMETER	MAXIMUM FIELD SIZE	CODE NAME	DEFINITION
DUBBING ORGANIZATION POC: NAME AGENCY ADDRESS TELEPHONE	24 48 48 20	R-x\DPOC1 R-x\DPOC2 R-x\DPOC3 R-x\DPOC4	POINT OF CONTACT AT THE DUBBING AGENCY: NAME, ADDRESS, AND TELEPHONE
<b>DATA</b>			
<b>NOTE:</b> DEFINE INFORMATION CONTAINED ON EACH TRACK OF THE TAPE OR EACH CHANNEL OF THE STORAGE MEDIA.			
TRACK NUMBER/ CHANNEL ID	2	R-x\TK1-n	SPECIFY THE TRACK NUMBER OR THE CHANNEL ID THAT CONTAINS THE DATA TO BE SPECIFIED.
RECORDING TECHNIQUE	6	R-x\TK2-n	SPECIFY THE RECORDING TECHNIQUE USED FOR THIS TRACK: FM/FM - 'FM/FM' HDDR - 'HDDR' PRE-DETECTION - 'PRE-D' DIRECT - 'DIRECT' FM-WIDE BAND GRP I - 'FMWBI' FM-WIDE BAND GRP II - 'FMWBII' FM-INTERMEDIATE BAND - 'FM-IM' FM-NARROW BAND - 'FM-NB' DOUBLE DENSITY - 'DOUDEN' ROTARY (SINGLE TRACK) - 'RO-K' ROTARY (MULTIPLEXED) - 'RO-MUX' SOLID STATE - 'SSR' OTHER - 'OTHER'
DATA SOURCE ID	32	R-x\DSI-n	SPECIFY THE DATA SOURCE IDENTIFICATION. FOR A SITE RECORDED MULTIPLEXED TRACK, PROVIDE A DATA SOURCE IDENTIFICATION.



**TABLE 9-3 (Cont'd). TAPE/STORAGE SOURCE ATTRIBUTES GROUP (R)**

PARAMETER	MAXIMUM FIELD SIZE	CODE NAME	DEFINITION
DATA DIRECTION	3	R-x\TK3-n	FORWARD - 'FWD' REVERSE - 'REV'
CHANNEL ENABLE	1	R-x\CHE-n	INDICATES IF SOURCE IS ENABLED. SOURCE MUST BE ENABLED TO GENERATE DATA PACKETS. 'T' = TRUE, 'F' = FALSE
CHANNEL DATA TYPE	6	R-x\CDT-n	SPECIFY THE TYPE OF SOURCE IF 'STO' WAS SPECIFIED IN G GROUP DATA SOURCE TYPE: PCM INPUT - 'PCMIN' ANALOG INPUT - 'ANAIN' DISCRETE INPUT - 'DISIN' IRIG TIME INPUT - 'TIMEIN' VIDEO INPUT - 'VIDIN', UART INPUT - 'UARTIN' 1553 INPUT - '1553IN', ARINC 429 INPUT - '429IN' MESSAGE DATA INPUT - 'MSGIN' IMAGE DATA INPUT - 'IMGIN'
<b>DATA TYPE ATTRIBUTES</b>			
<b>PCM DATA TYPE ATTRIBUTES</b>			
DATA LINK NAME	32	R-x\PDLN-n	IDENTIFY THE DATA LINK NAME CONSISTENT WITH THE MUX/MOD GROUP FOR A PCM CHANNEL.
DATA PACKING OPTION	3	R-x\PDP-n	HOW DATA IS PLACED IN THE PACKETS: UNPACKED - 'UN' PACKED WITH FRAME SYNC - 'PFS' THROUGHPUT MODE - 'TM'





**TABLE 9-3 (Cont'd). TAPE/STORAGE SOURCE ATTRIBUTES GROUP (R)**

PARAMETER	MAXIMUM FIELD SIZE	CODE NAME	DEFINITION
TYPE FORMAT	5	R-x\PTF-n	COMPRESSION TECHNIQUE FOR VIDEO RECORDED AS STANDARD CHAPTER 4 PCM. THE COMPRESSED DATA IS ENCAPSULATED IN ISO STANDARD TRANSPORT STREAM (TS) FRAMES. IF TYPE FORMAT IS 'OTHER', THEN A VENDOR SPEC IS REQUIRED TO IDENTIFY THE DATA COMPRESSION TECHNIQUE. SPECIFY 'NONE' IF DATA IS NOT VIDEO DATA. 'NONE' 'MPEG1' 'MPEG2' 'H261' 'WAVE' 'OTHER'
<b>BUS DATA TYPE ATTRIBUTES</b>			
DATA LINK NAME	32	R-x\BDLN-n	IDENTIFY THE DATA LINK NAME CONSISTENT WITH THE MUX/MOD GROUP FOR A BUS CHANNEL.
<b>ANALOG DATA TYPE ATTRIBUTES</b>			
NUMBER OF ANALOG CHANNELS/PKT	3	R-x\ACH\N-n	SPECIFY THE NUMBER OF ANALOG CHANNELS PER PACKET.
DATA PACKING OPTION	3	R-x\ADP-n	HOW DATA IS PLACED IN THE PACKETS: PACKED – 'YES' UNPACKED – 'NO'
SAMPLE RATE	7	R-x\ASR-n	SAMPLE RATE OF THE FASTEST CHANNEL(S) IN SAMPLES PER SECOND



**TABLE 9-3 (Cont'd). TAPE/STORAGE SOURCE ATTRIBUTES GROUP (R)**

PARAMETER	MAXIMUM FIELD SIZE	CODE NAME	DEFINITION
MEASUREMENT NAME	32	R-x\ AMN-n-m	IDENTIFY THE MEASUREMENT NAME CONSISTENT WITH THE MUX/MOD GROUP FOR AN ANALOG CHANNEL.
DATA LENGTH	2	R-x\ ADL-n-m	NUMBER OF BITS PER DATA WORD
BIT MASK	64	R-x\ AMSK-n-m	BINARY STRING OF 1s AND 0s TO IDENTIFY THE BITS IN A WORD LOCATION THAT ARE ASSIGNED TO THIS MEASUREMENT. IF THE FULL WORD IS USED FOR THIS MEASUREMENT, ENTER - 'FW'. LEFT-MOST BIT CORRESPONDS TO FIRST BIT TRANSMITTED
MEASUREMENT TRANSFER ORDER	1	R-x\ AMTO-n-m	MOST SIGNIFICANT BIT FIRST - 'M' LEAST SIGNIFICANT BIT FIRST - 'L' DEFAULT - 'D'
SAMPLE FACTOR	2	R-x\ ASF-n-m	$1/(2^N)$ TIMES THE FASTEST SAMPLE RATE (DEFINED ABOVE) GIVES THE SAMPLE RATE FOR THIS CHANNEL. SPECIFY THE VALUE 'N' IN THIS FIELD. VALID VALUES ARE 0 TO 15

**DISCRETE DATA TYPE ATTRIBUTES**



DISCRETE MODE	4	R-x\ DMOD-n	INDICATE THE MODE WHEREBY DISCRETE EVENTS ARE PLACED IN THE PACKETS: 'EV' – EVENT MODE 'SAMP' – SAMPLE MODE
SAMPLE RATE	7	R-x\ DSR-n	SAMPLE RATE IN SAMPLES PER SECOND
NUMBER OF DISCRETE MEASUREMENTS	3	R-x\ NDM\N-n	SPECIFY THE NUMBER OF DISCRETE MEASUREMENTS
MEASUREMENT NAME	32	R-x\ DMN-n-m	IDENTIFY THE MEASUREMENT NAME FOR ONE OR MORE DISCRETE BITS

**TABLE 9-3 (Cont'd). TAPE/STORAGE SOURCE ATTRIBUTES GROUP (R)**

PARAMETER	MAXIMUM FIELD SIZE	CODE NAME	DEFINITION
BIT MASK	64	R-x\ DMSK-n- m	BINARY STRING OF 1s AND 0s TO IDENTIFY THE BITS IN A WORD LOCATION THAT ARE ASSIGNED TO THIS MEASUREMENT. IF THE FULL WORD IS USED FOR THIS MEASUREMENT, ENTER - 'FW'. LEFT-MOST BIT CORRESPONDS TO FIRST BIT TRANSMITTED
MEASUREMENT TRANSFER ORDER	1	R-x\ DMTO-n- m	MOST SIGNIFICANT BIT FIRST - 'M' LEAST SIGNIFICANT BIT FIRST - 'L' DEFAULT - 'D'

**VIDEO DATA TYPE ATTRIBUTES**



VIDEO ENCODING DELAY	8	R-x\ VED-n	DELAY INTRODUCED BY VIDEO ENCODING HARDWARE IN MILLISECONDS
----------------------	---	---------------	---

**TIME DATA TYPE ATTRIBUTES**



TIME FORMAT	1	R-x\ TFMT-n	INDICATE THE FORMAT FOR THE IRIG TIME: IRIG-A - 'A'      IRIG-B - 'B' IRIG-G - 'G'      INTERNAL - 'I' NATIVE GPS TIME - 'N' UTC TIME FROM GPS - 'U'
-------------	---	----------------	--

**REFERENCE TRACK**

NUMBER OF REFERENCE TRACKS	1	R-x\ RT\N	SPECIFY THE NUMBER OF REFERENCE TRACKS
TRACK NUMBER	2	R-x\ RT1-n	STATE THE TRACK LOCATION OF THE REFERENCE SIGNAL
REFERENCE FREQUENCY	6	R-x\ RT2-n	FREQUENCY OF REFERENCE SIGNAL, IN kHz

**NOTE:** THERE WILL BE ONE TAPE/STORAGE SOURCE ATTRIBUTES GROUP FOR EACH TAPE OR STORAGE SOURCE.

<b>TABLE 9-3 (Cont'd). TAPE/STORAGE SOURCE ATTRIBUTES GROUP (R)</b>			
<b>PARAMETER</b>	<b>MAXIMUM FIELD SIZE</b>	<b>CODE NAME</b>	<b>DEFINITION</b>
<b>COMMENTS</b>			
COMMENTS	3200	R-x\COM	PROVIDE THE ADDITIONAL INFORMATION REQUESTED OR ANY OTHER INFORMATION DESIRED

9.5.5 Multiplex/Modulation (Mux/Mod) Attributes (M). The composite baseband waveform is received from the receiver or tape reproducer electronics and is passed to the demultiplexer/demodulator for further processing. Figure [9-5](#) summarizes the information that is required to continue processing the data. The composite baseband waveform may consist of any number of signals, which are modulated directly onto the RF carrier including a baseband data signal, and one or more subcarriers.

The baseband data signal may be PCM, pulse amplitude modulation (PAM), or analog data. The PCM and PAM data streams must be defined in terms of a data link name. This data link name is unique for each system that contains different data, has a different format, or has a different data rate. The analog measurand is typically converted into engineering units appropriate for the measurand. The measurement name provides the connection to the Data Conversion Attributes Group (C).

Subcarriers, both standard and nonstandard, may be part of the baseband composite waveform. These, in turn, may be modulated with PCM, PAM, or analog data. As with the baseband data signal, these data channels must be defined. Table [9-4](#) specifies the required information for the data signal attributes.

<b>Multiplex/Modulation Attributes Group (M)</b>		CODE NAME	REFERENCE PAGE
DATA SOURCE ID		(M-x\ID)	(9-28)
	*COMPOSITE SIGNAL STRUCTURE		(9-28)
	SIGNAL STRUCTURE TYPE	(M-x\BB1)	
	MODULATION SENSE	(M-x\BB2)	
	COMPOSITE LPF BANDWIDTH	(M-x\BB3)	
	*BASEBAND SIGNAL		(9-28)
	BASEBAND SIGNAL TYPE	(M-x\BSG1)	
	*LOW PASS FILTER		
	BANDWIDTH	(M-x\BSF1)	
	TYPE	(M-x\BSF2)	
	*BASEBAND DATA LINK TYPE		(9-29)
	*PCM OR PAM		
	OR DATA LINK NAME	(M-x\BB\DLN)	
	*ANALOG		
	MEASUREMENT NAME	(M-x\BB\MN)	
	*SUBCARRIERS		(9-29)
	NUMBER OF SUBCARRIERS	(M-x\SCO\N)	
	*IRIG SUBCARRIERS		
	NUMBER OF SCOs	(M-x\SI\N)	
	SCO NUMBER	(M-x\SI1-n)	
	SCO #n DATA TYPE	(M-x\SI2-n)	
	MODULATION SENSE	(M-x\SI3-n)	
	*LOW PASS FILTER		(9-30)
	BANDWIDTH	(M-x\SIF1-n)	
	TYPE	(M-x\SIF2-n)	
	*DATA LINK TYPE		(9-30)
	*PCM OR PAM		
	OR DATA LINK NAME	(M-x\SI\DLN-n)	
	*ANALOG		
	MEASUREMENT NAME	(M-x\SI\MN-n)	
	OTHER	(M-x\SO)	(9-30)
	REFERENCE CHANNEL	(M-x\RC)	
	*COMMENTS		
	COMMENTS	(M-x\COM)	(9-30)

\*Heading Only – No Data Entry

Figure 9-5. Multiplex/Modulation Attributes Group (M).

<b>TABLE 9-4. MULTIPLEX/MODULATION GROUP (M)</b>			
<b>PARAMETER</b>	<b>MAXIMUM FIELD SIZE</b>	<b>CODE NAME</b>	<b>DEFINITION</b>
DATA SOURCE ID	32	M-x\ID	DATA SOURCE IDENTIFICATION
<b>COMPOSITE SIGNAL STRUCTURE</b>			
SIGNAL STRUCTURE TYPE	7	M-x\BB1	SPECIFY THE COMPOSITE BASEBAND SIGNAL STRUCTURE: 'PCM'                               HYBRID: 'PAM'                               'ANA/SCO' 'ANALOG'                           'PAM/SCO' 'SCO's'                             'PCM/SCO' 'OTHER'
MODULATION SENSE	3	M-x\BB2	SPECIFY THE MODULATION SENSE: 'POS' – INDICATES THAT AN INCREASING VOLTAGE RESULTS IN AN INCREASE IN FREQUENCY. 'NEG' – INDICATES THAT A DECREASING VOLTAGE RESULTS IN AN INCREASE IN FREQUENCY
COMPOSITE LPF BANDWIDTH	6	M-x\BB3	GIVE THE LOW PASS BANDWIDTH OF THE COMPOSITE WAVEFORM (3 dB CUTOFF FREQUENCY), IN kHz.
<b>BASEBAND SIGNAL</b>			
BASEBAND SIGNAL TYPE	3	M-x\BSG1	TYPE OF BASEBAND DATA: 'PCM'   'ANA' (ANALOG) 'PAM'   'OTH' (OTHER)   'NON' (NONE)
<b>LOW PASS FILTER</b>			
BANDWIDTH	6	M-x\BSF1	SPECIFY LOW PASS FILTER BANDWIDTH (3 dB CUTOFF FREQUENCY), IN kHz.
TYPE	2	M-x\BSF2	SPECIFY THE FILTER TYPE: CONSTANT AMPLITUDE - 'CA' CONSTANT DELAY - 'CD' OTHER - 'OT', DEFINE IN THE COMMENTS RECORD.

<b>TABLE 9-4 (Cont'd). MULTIPLEX/MODULATION GROUP (M)</b>			
<b>PARAMETER</b>	<b>MAXIMUM FIELD SIZE</b>	<b>CODE NAME</b>	<b>DEFINITION</b>
<b>BASEBAND DATA LINK TYPE</b>			
<b>PCM OR PAM</b>			
DATA LINK NAME	32	M-x\ BB\DLN	SPECIFY THE DATA LINK NAME FOR PCM OR PAM DATA FORMAT.
<b>ANALOG</b>			
MEASUREMENT NAME	32	M-x\ BB\MN	GIVE THE MEASURAND NAME.
<b>SUBCARRIERS</b>			
NUMBER OF SUBCARRIERS	2	M-x\ SCO\N	SPECIFY THE NUMBER OF SUBCARRIERS ON THIS DATA LINK.
<b>IRIG SUBCARRIERS</b>			
NUMBER OF SCOs	2	M-x\ SI\N	SPECIFY THE NUMBER OF IRIG SUBCARRIERS.
SCO NUMBER	5	M-x\ SI1-n	GIVE THE IRIG CHANNEL NUMBER FOR THE SUBCARRIER.
SCO #n DATA TYPE	3	M-x\ SI2-n	SPECIFY THE TYPE OF DATA ON THE SUBCARRIER: PCM - 'PCM'            PAM - 'PAM' ANALOG - 'ANA'      OTHER - 'OTH'
MODULATION SENSE	3	M-x\ SI3-n	SPECIFY THE MODULATION SENSE: 'POS' - INDICATES THAT AN INCREASING VOLTAGE RESULTS IN AN INCREASE IN FREQUENCY 'NEG' - INDICATES THAT A DECREASING VOLTAGE RESULTS IN AN INCREASE IN FREQUENCY.

**TABLE 9-4 (Cont'd). MULTIPLEX/MODULATION GROUP (M)**

PARAMETER	MAXIMUM FIELD SIZE	CODE NAME	DEFINITION
<b>LOW PASS FILTER</b>			
BANDWIDTH	6	M-x\ SIF1-n	SPECIFY THE LOW PASS FILTER CUTOFF FREQUENCY (3 dB), IN kHz.
TYPE	2	M-x\ SIF2-n	SPECIFY THE FILTER TYPE: CONSTANT AMPLITUDE - 'CA' CONSTANT DELAY - 'CD' OTHER - 'OT', DEFINE IN THE COMMENTS RECORD.
<b>DATA LINK TYPE</b>			
<b>PCM OR PAM</b>			
DATA LINK NAME	32	M-x\ SI\DLN-n	SPECIFY THE DATA LINK NAME FOR PCM AND PAM DATA FORMATS.
<b>ANALOG</b>			
MEASUREMENT NAME	32	M-x\ SI\MN-n	GIVE THE MEASURAND NAME.
<b>NOTE:</b> REPEAT THE ABOVE FOR EACH IRIG SUBCARRIER ON THIS CARRIER.			
OTHER	1	M-x\SO	ARE THERE NONSTANDARD SUBCARRIERS? YES - 'Y' NO - 'N' DEFINE IN THE COMMENTS RECORD.
REFERENCE CHANNEL	6	M-x\RC	FREQUENCY OF REFERENCE CHANNEL IN kHz, IF APPLICABLE
<b>COMMENTS</b>			
COMMENTS	3200	M-x\COM	PROVIDE THE ADDITIONAL INFORMATION REQUESTED OR ANY OTHER INFORMATION DESIRED.



9.5.6 Digital Data Attributes. The digital data attributes are separated into three groups containing PCM-related attribute information. The PCM Format Attributes Group (P) is described in subparagraph 9.5.6.1. The PCM Measurement Description Attributes, contained in (D), are described in subparagraph 9.5.6.2. Subparagraph 9.5.6.3 depicts the MIL-STD-1553 or ARINC 429 Bus Data Attributes (B).

9.5.6.1 PCM Format Attributes (P). The PCM Format Attributes Group contains the information required to decommutate the PCM data stream. Operations of both class I and II are included. (Limited information is incorporated for class II operation.) Figure 9-6 presents the flow and summary of the information required. In general, only standard methods of synchronization have been included except for cases where considerable application is already in place. Inclusion should not be taken to mean that the nonstandard approaches are better or desired. Table 9-5 contains the PCM Format Attributes. The group defines and specifies the frame format and the information necessary to set up the PCM decommutation. Refer to Chapter 4 for the definition of terms (such as major and minor frames and subframes) and word numbering conventions.

<b>PCM Format Attributes Group (P)</b>		<b>CODE NAME</b>	<b>REFERENCE PAGE</b>
DATA LINK NAME		(P-d\DLN)	(9-34)
	*INPUT DATA		(9-34)
	PCM CODE	(P-d\D1)	
	BIT RATE	(P-d\D2)	
	ENCRYPTED	(P-d\D3)	
	POLARITY	(P-d\D4)	
	AUTO-POLARITY CORRECTION	(P-d\D5)	
	DATA DIRECTION	(P-d\D6)	
	DATA RANDOMIZED	(P-d\D7)	
	RANDOMIZER LENGTH	(P-d\D8)	
	*FORMAT		(9-35)
	TYPE FORMAT	(P-d\TF)	
	COMMON WORD LENGTH	(P-d\F1)	
	WORD TRANSFER ORDER	(P-d\F2)	
	PARITY	(P-d\F3)	
	PARITY TRANSFER ORDER	(P-d\F4)	
	*MINOR FRAME		(9-35)
	NUMBER OF MINOR FRAMES IN MAJOR FRAME	(P-d\MF\N)	
	NUMBER OF WORDS IN A MINOR FRAME	(P-d\MF1)	
	NUMBER OF BITS IN A MINOR FRAME	(P-d\MF2)	
	SYNC TYPE	(P-d\MF3)	
	*SYNCHRONIZATION PATTERN		(9-36)
	LENGTH	(P-d\MF4)	
	PATTERN	(P-d\MF5)	
	*SYNCHRONIZATION CRITERIA		(9-36)
	IN SYNC CRITERIA	(P-d\SYNC1)	
	SYNC PATTERN CRITERIA	(P-d\SYNC2)	
Continued on next page			

Figure 9-6. PCM Format Attributes Group (P).

	*OUT OF SYNCHRONIZATION CRITERIA		(9-36)
	NUMBER OF DISAGREES	(P-d\SYNC3)	
	SYNC PATTERN CRITERIA	(P-d\SYNC4)	
	*MINOR FRAME FORMAT DEFINITION		(9-37)
	WORD NUMBER	(P-d\MFW1-n)	
	NUMBER OF BITS IN WORD	(P-d\MFW2-n)	
	*SUBFRAME SYNCHRONIZATION		(9-37)
	NUMBER OF SUBFRAME ID COUNTERS	(P-d\ISF\N)	
	SUBFRAME ID COUNTER NAME	(P-d\ISF1-n)	
	SUBFRAME SYNC TYPE	(P-d\ISF2-n)	
	*ID COUNTER		(9-37)
	SUBFRAME ID COUNTER LOCATION	(P-d\IDC1-n)	
	ID COUNTER WORD LENGTH	(P-d\IDC2-n)	
	ID COUNTER MSB STARTING BIT LOCATION	(P-d\IDC3-n)	
	ID COUNTER LENGTH	(P-d\IDC4-n)	(9-38)
	ID COUNTER TRANSFER ORDER	(P-d\IDC5-n)	
	ID COUNTER INITIAL VALUE	(P-d\IDC6-n)	
	INITIAL COUNT SUBFRAME NUMBER	(P-d\IDC7-n)	
	ID COUNTER END VALUE	(P-d\IDC8-n)	
	END COUNT SUBFRAME NUMBER	(P-d\IDC9-n)	
	COUNT DIRECTION	(P-d\IDC10-n)	
	* SUBFRAME DEFINITION		(9-38)
	NUMBER OF SUBFRAMES	(P-d\SF\N-n)	
	SUBFRAME NAME	(P-d\SF1-n-m)	
	SUPERCOM	(P-d\SF2-n-m)	
	LOCATION DEFINITION	(P-d\SF3-n-m)	
	SUBFRAME LOCATION	(P-d\SF4-n-m-w)	
	INTERVAL	(P-d\SF5-n-m)	
	SUBFRAME DEPTH	(P-d\SF6-n-m)	
	*ASYNCHRONOUS EMBEDDED FORMAT		(9-39)
	NUMBER OF ASYNCHRONOUS EMBEDDED FORMATS	(P-d\AEF\N)	
	DATA LINK NAME	(P-d\AEF\DLN-n)	(9-39)
	SUPERCOM	(P-d\AEF1-n)	
	LOCATION DEFINITION	(P-d\AEF2-n)	
	LOCATION	(P-d\AEF3-n-w)	
	INTERVAL	(P-d\AEF4-n)	(9-40)
	WORD LENGTH	(P-d\AEF5-n-w)	
	MASK	(P-d\AEF6-n-w)	
	*FORMAT CHANGE		(9-41)
	*FRAME FORMAT IDENTIFIER		
	LOCATION	(P-d\FFI1)	
	MASK	(P-d\FFI2)	
	Continued on next page		

Figure 9-6 (Cont'd). PCM Format Attributes Group (P).

		*MEASUREMENT LIST CHANGE		(9-41)
	OR	NUMBER OF MEASUREMENT LISTS	(P-d\MLC\N)	
		FFI PATTERN	(P-d\MLC1-n)	
		MEASUREMENT LIST NAME	(P-d\MLC2-n)	
		*FORMAT STRUCTURE CHANGE		(9-42)
		NUMBER OF FORMATS	(P-d\FSC\N)	
		FFI PATTERN	(P-d\FSC1-n)	
		DATA LINK ID	(P-d\FSC2-n)	
		*ALTERNATE TAG AND DATA		(9-42)
		NUMBER OF TAGS	(P-d\ALT\N)	
		NUMBER OF BITS IN TAG	(P-d\ALT1)	
		NUMBER OF BITS IN DATA WORD	(P-d\ALT2)	
		FIRST TAG LOCATION	(P-d\ALT3)	
		SEQUENCE	(P-d\ALT4)	
		*ASYNCHRONOUS DATA MERGE FORMAT		(9-42)
		NUMBER OF ASYNCHRONOUS DATA MERGE FORMATS	(P-d\ADM\N)	
		DATA MERGE NAME	(P-d\ADM\DMN-n)	(9-43)
		SUPERCOM	(P-d\ADM1-n)	
		LOCATION DEFINITION	(P-d\ADM2-n)	
		LOCATION	(P-d\ADM3-n-w)	
		INTERVAL	(P-d\ADM4-n)	
		DATA LENGTH	(P-d\ADM5-n)	
		MSB LOCATION	(P-d\ADM6-n)	
		PARITY	(P-d\ADM7-n)	
		*COMMENTS		
		COMMENTS	(P-d\COM)	(9-44 )
<b>*Heading Only - No Data Entry</b>				

Figure 9-6 (Cont'd). PCM Format Attributes Group (P).

**TABLE 9-5. PCM FORMAT ATTRIBUTES GROUP (P)**

<b>TABLE 9-5. PCM FORMAT ATTRIBUTES GROUP (P)</b>			
<b>PARAMETER</b>	<b>MAXIMUM FIELD SIZE</b>	<b>CODE NAME</b>	<b>DEFINITION</b>
DATA LINK NAME	32	P-d\DLN	IDENTIFY THE DATA LINK NAME CONSISTENT WITH THE MUX/MOD GROUP.
<b>INPUT DATA</b>			
PCM CODE	6	P-d\D1	DEFINE THE DATA FORMAT CODE: 'NRZ-L' 'BIO-L' 'RNRZ-L' 'NRZ-M' 'BIO-M' 'OTHER' 'NRZ-S' 'BIO-S'
BIT RATE	9	P-d\D2	DATA RATE IN BITS PER SECOND. SCIENTIFIC NOTATION MAY BE USED.
ENCRYPTED	1	P-d\D3	DATA IS ENCRYPTED – 'E' DATA IS UNENCRYPTED – 'U' IF THE DATA IS ENCRYPTED, PROVIDE DETAILS IN COMMENTS RECORD.
POLARITY	1	P-d\D4	DATA POLARITY: NORMAL – 'N' INVERTED – 'I'
AUTO-POLARITY CORRECTION	1	P-d\D5	IS AUTOMATIC POLARITY CORRECTION TO BE USED? YES – 'Y' NO – 'N'
DATA DIRECTION	1	P-d\D6	TIME SEQUENCE OF DATA: NORMAL – 'N' REVERSED – 'R'
DATA RANDOMIZED	1	P-d\D7	YES – 'Y' NO – 'N'
RANDOMIZER LENGTH	3	P-d\D8	SPECIFY THE RANDOMIZER LENGTH: STANDARD (15 BITS) – 'STD' OTHER – 'OTH', DEFINE IN COMMENTS RECORD NOT APPLICABLE – 'N/A'

**TABLE 9-5 (Cont'd). PCM FORMAT ATTRIBUTES GROUP (P)**

PARAMETER	MAXIMUM FIELD SIZE	CODE NAME	DEFINITION
<b>FORMAT</b>			
TYPE FORMAT	4	P-d\TF	TYPE OF PCM FORMAT: CLASS I - 'ONE' CLASS II - 'TWO' 1553 BUS - '1553' BUS - 'BUS' ALTERNATE TAG AND DATA - 'ALTD' OTHER - 'OTHR', DESCRIBE IN COMMENTS RECORD.
COMMON WORD LENGTH	2	P-d\F1	NUMBER OF BITS IN COMMON WORD LENGTH
WORD TRANSFER ORDER	1	P-d\F2	DEFINE THE DEFAULT FOR THE FIRST BIT TRANSFERRED IN NORMAL TIME SEQUENCE: MOST SIGNIFICANT BIT - 'M' LEAST SIGNIFICANT BIT - 'L'
PARITY	2	P-d\F3	NORMAL WORD PARITY EVEN - 'EV' ODD - 'OD' NONE - 'NO'
PARITY TRANSFER ORDER	1	P-d\F4	PARITY BIT LOCATION LEADS WORD - 'L' TRAILS WORD - 'T'
<b>MINOR FRAME</b>			
NUMBER OF MINOR FRAMES IN MAJOR FRAME	3	P-d\MF\N	NUMBER OF MINOR FRAMES IN A MAJOR FRAME
NUMBER OF WORDS IN A MINOR FRAME	4	P-d\MF1	SPECIFY THE NUMBER OF WORDS IN A MINOR FRAME, AS DEFINED IN PARAGRAPH 4.3.
NUMBER OF BITS IN A MINOR FRAME	5	P-d\MF2	NUMBER OF BITS IN A MINOR FRAME INCLUDING MINOR FRAME SYNCHRONIZATION PATTERN

<b>TABLE 9-5 (Cont'd). PCM FORMAT ATTRIBUTES GROUP (P)</b>			
<b>PARAMETER</b>	<b>MAXIMUM FIELD SIZE</b>	<b>CODE NAME</b>	<b>DEFINITION</b>
SYNC TYPE	3	P-d\MF3	DEFINE MINOR FRAME SYNCHRONIZATION TYPE: FIXED PATTERN - 'FPT' OTHER - 'OTH'
<b>SYNCHRONIZATION PATTERN</b>			
LENGTH	2	P-d\MF4	SPECIFY THE MINOR FRAME SYNCHRONIZATION PATTERN LENGTH IN NUMBER OF BITS.
PATTERN	33	P-d\MF5	DEFINE MINOR FRAME SYNCHRONIZATION PATTERN IN BITS ("1"s and "0"s) WITH THE LEFT MOST BIT AS THE "FIRST BIT TRANSMITTED"
<b>SYNCHRONIZATION CRITERIA</b>			
IN SYNC CRITERIA	2	P-d\SYNC1	THIS SPECIFIES THE DESIRED CRITERIA FOR DECLARING THE SYSTEM TO BE IN SYNC: FIRST GOOD SYNC - 0 CHECK - NUMBER OF AGREES (1 OR GREATER) NOT SPECIFIED - 'NS'
SYNC PATTERN CRITERIA	2	P-d\SYNC2	NUMBER OF BITS THAT MAY BE IN ERROR IN THE SYNCHRONIZATION PATTERN
<b>OUT OF SYNCHRONIZATION CRITERIA</b>			
NUMBER OF DISAGREES	2	P-d\SYNC3	SPECIFIES THE DESIRED CRITERIA FOR DECLARING THE SYSTEM OUT OF SYNC: NUMBER OF DISAGREES, (1 OR GREATER) NOT SPECIFIED - 'NS'
SYNC PATTERN CRITERIA	2	P-d\SYNC4	NUMBER OF BITS THAT MAY BE IN ERROR IN THE SYNCHRONIZATION PATTERN

**TABLE 9-5 (Cont'd). PCM FORMAT ATTRIBUTES GROUP (P)**

PARAMETER	MAXIMUM FIELD SIZE	CODE NAME	DEFINITION
<b>MINOR FRAME FORMAT DEFINITION</b>			
WORD NUMBER	4	P-d\MFW1-n	WORD POSITION #n IN A MINOR FRAME, OR FOR CLASS II SYSTEMS, THE POSITION IN THE DEFINED FRAME. WORD POSITION 1 FOLLOWS THE SYNCHRONIZATION PATTERN.
NUMBER OF BITS IN WORD	2	P-d\MFW2-n	THE NUMBER OF BITS IN WORD POSITION #n. IF DEFAULT VALUE, DO NOT INCLUDE.
<p><b>NOTE:</b> THE ABOVE PAIR SET MUST BE DEFINED FOR ALL WORDS THAT HAVE A LENGTH OTHER THAN THE COMMON WORD LENGTH. THEREFORE, ALL WORD POSITIONS NOT INCLUDED IN THE ABOVE WILL HAVE THE COMMON WORD LENGTH AS A DEFAULT VALUE.</p>			
<b>SUBFRAME SYNCHRONIZATION</b>			
NUMBER OF SUBFRAME ID COUNTERS	2	P-d\ISF\N	SPECIFY THE NUMBER OF SUBFRAME ID COUNTERS DEFINED WITHIN THE MINOR FRAME.
SUBFRAME ID COUNTER NAME	32	P-d\ISF1-n	SPECIFY THE SUBFRAME ID COUNTER NAME.
SUBFRAME SYNC TYPE	2	P-d\ISF2-n	DEFINE THE SUBFRAME SYNCHRONIZATION TYPE: ID COUNTER - 'ID' OTHER - 'OT' DEFINE IN COMMENTS.
<b>ID COUNTER</b>			
SUBFRAME ID COUNTER LOCATION	4	P-d\IDC1-n	IF ID COUNTER IS DESIGNATED AS THE SUBFRAME SYNC TYPE, GIVE THE MINOR FRAME WORD POSITION OF THE COUNTER.
ID COUNTER WORD LENGTH	2	P-d\IDC2-n	SPECIFY THE MINOR FRAME WORD LENGTH OF THE WORD CONTAINING THE ID COUNTER, NUMBER OF BITS.

**TABLE 9-5 (Cont'd). PCM FORMAT ATTRIBUTES GROUP (P)**

<b>PARAMETER</b>	<b>MAXIMUM FIELD SIZE</b>	<b>CODE NAME</b>	<b>DEFINITION</b>
ID COUNTER MSB STARTING BIT LOCATION	2	P-d\IDC3-n	SPECIFY THE BIT LOCATION OF THE ID COUNTER MSB WITHIN THE WORD.
ID COUNTER LENGTH	2	P-d\IDC4-n	SPECIFY THE SUBFRAME ID COUNTER LENGTH, NUMBER OF BITS.
ID COUNTER TRANSFER ORDER	1	P-d\IDC5-n	SPECIFY WHETHER THE MOST OR LEAST SIGNIFICANT BIT IS TRANSFERRED FIRST: MOST SIGNIFICANT - 'M' LEAST SIGNIFICANT - 'L'
ID COUNTER INITIAL VALUE	3	P-d\IDC6-n	SPECIFY THE INITIAL VALUE OF THE ID COUNTER.
INITIAL COUNT SUBFRAME NUMBER	3	P-d\IDC7-n	SPECIFY THE MINOR FRAME NUMBER ASSOCIATED WITH THE INITIAL COUNT VALUE.
ID COUNTER END VALUE	3	P-d\IDC8-n	SPECIFY THE END VALUE OF THE ID COUNTER.
END COUNT SUBFRAME NUMBER	3	P-d\IDC9-n	SPECIFY THE MINOR FRAME NUMBER ASSOCIATED WITH THE END COUNT VALUE.
COUNT DIRECTION	3	P-d\IDC10-n	SPECIFY THE DIRECTION OF THE COUNT INCREMENT: INCREASING - 'INC' DECREASING - 'DEC'
<b>SUBFRAME DEFINITION</b>			
NUMBER OF SUBFRAMES	4	P-d\SF\N-n	SPECIFY THE NUMBER OF SUBFRAMES ASSOCIATED WITH THE SUBFRAME ID COUNTER NAMED ABOVE.
SUBFRAME NAME	32	P-d\SF1-n-m	SPECIFY THE SUBFRAME NAME.



**TABLE 9-5 (Cont'd). PCM FORMAT ATTRIBUTES GROUP (P)**

PARAMETER	MAXIMUM FIELD SIZE	CODE NAME	DEFINITION
SUPERCOM	2	P-d\ SF2-n-m	IF NOT SUPERCOMMUTATED, ENTER - 'NO'. OTHERWISE, ENTER THE NUMBER OF WORD POSITIONS.
LOCATION DEFINITION	2	P-d\ SF3-n-m	IF SUPERCOMMUTATED, SPECIFY HOW THE WORD LOCATIONS ARE DEFINED: FIRST WORD AND INTERVAL - 'FI' EVERY LOCATION - 'EL' NOT APPLICABLE - 'NA'
SUBFRAME LOCATION	4	P-d\ SF4-n-m-w	SPECIFY THE FIRST WORD WITHIN THE MINOR FRAME THAT CONTAINS THE SUBFRAME IDENTIFIED. FOR THE CASE WHEN EVERY WORD LOCATION IS DEFINED, REPEAT THIS ENTRY FOR EACH WORD POSITION APPLICABLE. FOR THE FIRST WORD AND INTERVAL, INCLUDE THE NEXT ENTRY TO DEFINE THE INTERVAL.
INTERVAL	4	P-d\ SF5-n-m	SPECIFY THE INTERVAL TO BE USED TO DEFINE THE WORD LOCATIONS.
SUBFRAME DEPTH	3	P-d\ SF6-n-m	SPECIFY THE SUBFRAME DEPTH. IF NO ENTRY, THEN THE SUBFRAME ID COUNTER DEPTH WILL BE USED AS THE DEFAULT VALUE.
<b>NOTE:</b> REPEAT THE ABOVE FOR EACH SUBFRAME IN THE MINOR FRAME FORMAT.			
<b>ASYNCHRONOUS EMBEDDED FORMAT</b>			
NUMBER OF ASYNCHRONOUS EMBEDDED FORMATS	1	P-d\AEF\N	SPECIFY THE NUMBER OF ASYNCHRONOUS EMBEDDED FORMATS: ONE - '1' TWO - '2' NONE - '0'
DATA LINK NAME	32	P-d\AEF\ DLN-n	PROVIDE THE DATA LINK NAME FOR THIS ASYNCHRONOUS EMBEDDED FORMAT. REPEAT NAME AND THE FOLLOWING ENTRIES FOR THE SECOND FORMAT, AS APPROPRIATE. (A SEPARATE DATA LINK DEFINITION MUST BE PROVIDED FOR EACH ASYNCHRONOUS EMBEDDED FORMAT.)

**TABLE 9-5 (Cont'd). PCM FORMAT ATTRIBUTES GROUP (P)**

<b>PARAMETER</b>	<b>MAXIMUM FIELD SIZE</b>	<b>CODE NAME</b>	<b>DEFINITION</b>
SUPERCOM	3	P-d\AEF1-n	IF THE ASYNCHRONOUS FORMAT IS NOT SUPERCOMMUTATED, ENTER - 'NO'. OTHERWISE, ENTER THE NUMBER OF HOST MINOR FRAME WORDS THAT ARE USED.
LOCATION DEFINITION	2	P-d\AEF2-n	IF SUPERCOMMUTATED, SPECIFY HOW THE WORD LOCATIONS ARE DEFINED: FIRST WORD AND INTERVAL - 'FI' EVERY LOCATION - 'EL' CONTIGUOUS WORDS - 'CW' NOT APPLICABLE - 'NA'
LOCATION	4	P-d\AEF3-n-w	SPECIFY THE FIRST WORD WITHIN THE MINOR FRAME THAT CONTAINS THE ASYNCHRONOUS EMBEDDED FORMAT IDENTIFIED. FOR THE METHOD WHEN EVERY WORD LOCATION IS DEFINED, REPEAT THIS ENTRY FOR EACH WORD POSITION APPLICABLE. FOR THE FIRST WORD AND INTERVAL METHOD, INCLUDE THE NEXT ENTRY TO DEFINE THE INTERVAL.
INTERVAL	4	P-d\AEF4-n	SPECIFY THE INTERVAL TO BE USED TO DEFINE THE ASYNCHRONOUS EMBEDDED FORMAT LOCATIONS.
WORD LENGTH	2	P-d\AEF5-n-w	SPECIFY THE NUMBER OF EMBEDDED BITS IN THIS HOST WORD LOCATION.
MASK	64	P-d\AEF6-n-w	IF THE ASYNCHRONOUS PORTION OF THE WORD IS SHORTER THAN THE WORD LENGTH, THEN PROVIDE THE BINARY MASK REQUIRED TO INDICATE WHICH BITS ARE USED (1s USED, 0s NOT USED). LEFT-MOST BIT CORRESPONDS TO FIRST BIT TRANSMITTED.

**TABLE 9-5 (Cont'd). PCM FORMAT ATTRIBUTES GROUP (P)**

<b>PARAMETER</b>	<b>MAXIMUM FIELD SIZE</b>	<b>CODE NAME</b>	<b>DEFINITION</b>
<b>FORMAT CHANGE</b>			
<b>FRAME FORMAT IDENTIFIER</b>			
LOCATION	4	P-d\FFI1	SPECIFY THE POSITION IN THE MINOR FRAME THAT CONTAINS THE FRAME FORMAT IDENTIFICATION (FFI) WORD. IF MORE THAN ONE WORD LOCATION, PROVIDE THE DETAILS IN THE COMMENTS RECORD.
MASK	64	P-d\FFI2	IF THE FFI IS SHORTER THAN THE WORD LENGTH, THEN PROVIDE THE BINARY MASK REQUIRED TO INDICATE WHICH BITS ARE USED. LEFTMOST BIT CORRESPONDS TO FIRST BIT TRANSMITTED.
<b>MEASUREMENT LIST CHANGE</b>			
NUMBER OF MEASUREMENT LISTS	2	P-d\MLC\N	SPECIFY THE NUMBER OF MEASUREMENT LISTS THAT ARE REQUIRED TO BE SELECTED. IF NONE, ENTER 'NO'. OTHERWISE, ENTER THE NUMBER, n.
FFI PATTERN	16	P-d\MLC1-n	SPECIFY THE FFI PATTERN THAT CORRESPONDS TO THE MEASUREMENT LIST (1s and 0s). THIS ENTRY AND THE NEXT ARE AN ORDERED PAIR.
MEASUREMENT LIST NAME	32	P-d\MLC2-n	SPECIFY THE MEASUREMENT LIST NAME.

**TABLE 9-5 (Cont'd). PCM FORMAT ATTRIBUTES GROUP (P)**

PARAMETER	MAXIMUM FIELD SIZE	CODE NAME	DEFINITION
<b>FORMAT STRUCTURE CHANGE</b>			
NUMBER OF FORMATS	2	P-d\FSC\N	SPECIFY THE NUMBER OF FORMATS THAT ARE TO BE DEFINED.
FFI PATTERN	16	P-d\FSC1-n	SPECIFY THE FFI PATTERN THAT CORRESPONDS TO THE FORMAT THAT IS DEFINED. THIS ENTRY AND THE NEXT ARE AN ORDERED PAIR.
DATA LINK ID	32	P-d\FSC2-n	IDENTIFY THE FORMAT THAT CORRESPONDS TO THIS FFI CODE.
<b>ALTERNATE TAG AND DATA</b>			
NUMBER OF TAGS	3	P-d\ALT\N	SPECIFY THE NUMBER OF PARAMETERS INCLUDED WITHIN THIS CATEGORY, THAT IS, THE NUMBER OF TAGS.
NUMBER OF BITS IN TAG	2	P-d\ALT1	SPECIFY THE NUMBER OF BITS THAT ARE IN THIS TAG.
NUMBER OF BITS IN DATA WORD	2	P-d\ALT2	SPECIFY THE NUMBER OF BITS THAT ARE IN THE COMMON DATA WORD.
FIRST TAG LOCATION	2	P-d\ALT3	IDENTIFY THE LOCATION OF THE START OF THE FIRST TAG LOCATION IN TERMS OF BITS, WITH THE FIRST BIT POSITION AFTER THE SYNCHRONIZATION PATTERN BEING NUMBER 1.
SEQUENCE	1	P-d\ALT4	IF THE TAG/DATA WORD SEQUENCE IS TAG, THEN DATA ENTER 'N' FOR NORMAL. IF THE DATA PRECEDES THE TAG, ENTER 'R' FOR REVERSED.
<b>ASYNCHRONOUS DATA MERGE FORMAT</b>			
NUMBER OF ASYNCHRONOUS DATA MERGE FORMATS	1	P-d\ADM\N	SPECIFY THE NUMBER OF ASYNCHRONOUS DATA MERGE FORMATS.

**TABLE 9-5 (Cont'd). PCM FORMAT ATTRIBUTES GROUP (P)**

PARAMETER	MAXIMUM FIELD SIZE	CODE NAME	DEFINITION
DATA MERGE NAME	32	P-d\ADM\ DMN-n	PROVIDE THE DATA MERGE NAME FOR THIS ASYNCHRONOUS DATA MERGE FORMAT. THIS CAN BE USED TO IDENTIFY THE SOURCE OF THE DATA MERGE FORMAT, AS APPROPRIATE. (USE THE COMMENTS FIELD TO DESCRIBE THIS DATA SOURCE FOR THE ASYNCHRONOUS DATA MERGE FORMAT.)
SUPERCOM	3	P-d\ADM1-n	IF THE ASYNCHRONOUS DATA MERGE FORMAT IS NOT SUPERCOMMUTATED, ENTER - 'NO'. OTHERWISE, ENTER THE NUMBER OF HOST MINOR FRAME WORDS THAT ARE USED.
LOCATION DEFINITION	2	P-d\ADM2-n	IF SUPERCOMMUTATED, SPECIFY HOW THE WORD LOCATIONS ARE DEFINED: FIRST WORD AND INTERVAL - 'FI' EVERY LOCATION - 'EL' CONTIGUOUS WORDS - 'CW' NOT APPLICABLE - 'NA'
LOCATION	4	P-d\ ADM3-n-w	SPECIFY THE FIRST WORD WITHIN THE MINOR FRAME THAT CONTAINS THE ASYNCHRONOUS DATA MERGE FORMAT IDENTIFIED. FOR THE METHOD WHEN EVERY WORD LOCATION IS DEFINED, REPEAT THIS ENTRY FOR EACH WORD POSITION APPLICABLE. FOR THE FIRST WORD AND INTERVAL METHOD, INCLUDE THE NEXT ENTRY TO DEFINE THE INTERVAL.
INTERVAL	4	P-d\ADM4-n	SPECIFY THE INTERVAL TO BE USED TO DEFINE THE ASYNCHRONOUS DATA MERGE FORMAT LOCATIONS.
DATA LENGTH	2	P-d\ADM5-n	SPECIFY THE NUMBER OF DATA BITS USED IN THIS DATA MERGE FORMAT.

<b>TABLE 9-5 (Cont'd). PCM FORMAT ATTRIBUTES GROUP (P)</b>			
<b>PARAMETER</b>	<b>MAXIMUM FIELD SIZE</b>	<b>CODE NAME</b>	<b>DEFINITION</b>
MSB LOCATION	2	P-d\ADM6-n	PROVIDE THE MOST SIGNIFICANT BIT (MSB) POSITION WITHIN THE HOST MINOR FRAME LOCATION.
PARITY	2	P-d\ADM7-n	IF USED, SPECIFY THE PARITY INFORMATION: EVEN - 'EV'                      ODD - 'OD' NONE - 'NO'
<b>COMMENTS</b>			
COMMENTS	6400	P-d\COM	PROVIDE THE ADDITIONAL INFORMATION REQUESTED OR ANY OTHER INFORMATION DESIRED.

9.5.6.2 PCM Measurement Description Group (D). Figure 9-7 and Table 9-6 contain the PCM Measurement Descriptions. The descriptions define each measurand or data item of interest within the frame format specified in the PCM attributes. Table 9-6 includes the measurement name, which links the measurement to the Data Conversion Attributes Group.

<b>PCM Measurement Description Group (D)</b>		<b>CODE NAME</b>	<b>REFERENCE PAGE</b>
<b>DATA LINK NAME</b>		<b>(D-x\DLN)</b>	(9-47)
	NUMBER OF MEASUREMENT LISTS	(D-x\ML\N)	
	MEASUREMENT LIST NAME	(D-x\MLN-y)	
	NUMBER OF MEASURANDS	(D-x\MN\N-y)	
	MEASUREMENT NAME	(D-x\MN-y-n)	(9-47)
	PARITY	(D-x\MN1-y-n)	
	PARITY TRANSFER ORDER	(D-x\MN2-y-n)	
	MEASUREMENT TRANSFER ORDER	(D-x\MN3-y-n)	
	*MEASUREMENT LOCATION		(9-48)
	MEASUREMENT LOCATION TYPE	(D-x\LT-y-n)	
	*MINOR FRAME		(9-48)
	MINOR FRAME LOCATION	(D-x\MF-y-n)	
	BIT MASK	(D-x\MFM-y-n)	
	*MINOR FRAME SUPERCOMMUTATED		(9-48)
OR	NUMBER OF MINOR FRAME LOCATIONS	(D-x\MFS\N-y-n)	
	LOCATION DEFINITION	(D-x\MFS1-y-n)	
	*INTERVAL		(9-48)
OR	LOCATION IN MINOR FRAME	(D-x\MFS2-y-n)	
	BIT MASK	(D-x\MFS3-y-n)	(9-49)
	INTERVAL	(D-x\MFS4-y-n)	
	*EVERY LOCATION		(9-49)
	MINOR FRAME LOCATION	(D-x\MFSW-y-n-e)	
	BIT MASK	(D-x\MFSM-y-n-e)	
	*MINOR FRAME FRAGMENTED		(9-49)
OR	NUMBER OF FRAGMENTS	(D-x\FMF\N-y-n)	
	MEASUREMENT WORD LENGTH	(D-x\FMF1-y-n)	
	LOCATION DEFINITION	(D-x\FMF2-y-n)	
	*INTERVAL		(9-50)
OR	LOCATION IN MINOR FRAME	(D-x\FMF3-y-n)	
	BIT MASK	(D-x\FMF4-y-n)	
	INTERVAL	(D-x\FMF5-y-n)	
	*EVERY LOCATION		(9-50)
	MINOR FRAME LOCATION	(D-x\FMF6-y-n-e)	
	BIT MASK	(D-x\FMF7-y-n-e)	
	FRAGMENT TRANSFER ORDER	(D-x\FMF8-y-n-e)	
	FRAGMENT POSITION	(D-x\FMF9-y-n-e)	
	* SUBFRAME		(9-51)
OR	SUBFRAME NAME	(D-x\SF1-y-n)	
	LOCATION IN SUBFRAME	(D-x\SF2-y-n)	
	BIT MASK	(D-x\SFM-y-n)	

Continued on next page

Figure 9-7. PCM Measurement Description Group (D).

		*SUBFRAME SUPERCOMMUTATED		(9-51)	
OR		SUBFRAME NAME	(D-x\SFS1-y-n)		
		NUMBER OF SUBFRAME LOCATIONS	(D-x\SFSN-y-n)		
		LOCATION DEFINITION	(D-x\SFS2-y-n)		
		*INTERVAL		(9-51)	
	OR		LOCATION IN SUBFRAME	(D-x\SFS3-y-n)	
			BIT MASK	(D-x\SFS4-y-n)	
			INTERVAL	(D-x\SFS5-y-n)	
		*EVERY LOCATION		(9-52)	
		SUBFRAME LOCATION	(D-x\SFS6-y-n-e)		
		BIT MASK	(D-x\SFS7-y-n-e)		
		*SUBFRAME FRAGMENTED		(9-52)	
OR		NUMBER OF FRAGMENTS	(D-x\FSFN-y-n)		
		MEASUREMENT WORD LENGTH	(D-x\FSF1-y-n)		
		NUMBER OF SUBFRAMES	(D-x\FSF2N-y-n)		
		SUBFRAME NAME	(D-x\FSF3-y-n-m)		
		LOCATION DEFINITION	(D-x\FSF4-y-n-m)		
		*INTERVAL		(9-53)	
	OR		LOCATION IN SUBFRAME	(D-x\FSF5-y-n-m)	
			BIT MASK	(D-x\FSF6-y-n-m)	
			INTERVAL	(D-x\FSF7-y-n-m)	
		*EVERY LOCATION		(9-53)	
		SUBFRAME LOCATION	(D-x\FSF8-y-n-m-e)		
	BIT MASK	(D-x\FSF9-y-n-m-e)			
	FRAGMENT TRANSFER ORDER	(D-x\FSF10-y-n-m-e)			
	FRAGMENT POSITION	(D-x\FSF11-y-n-m-e)			
	*WORD AND FRAME		(9-54)		
	NUMBER OF MEASUREMENT LOCATIONS	(D-x\MMLN-y-n)			
	NUMBER OF FRAGMENTS	(D-x\MNFN-y-n-m)			
	MEASUREMENT WORD LENGTH	(D-x\MWL-y-n-m)			
	WORD POSITION	(D-x\WP-y-n-m-e)			
	WORD INTERVAL	(D-x\WI-y-n-m-e)			
	FRAME POSITION	(D-x\FP-y-n-m-e)			
	FRAME INTERVAL	(D-x\FI-y-n-m-e)			
	BIT MASK	(D-x\WFM-y-n-m-e)			
	FRAGMENT TRANSFER ORDER	(D-x\WFT-y-n-m-e)			
	FRAGMENT POSITION	(D-x\WFP-y-n-m-e)			
	*COMMENTS				
	COMMENTS	(D-x\COM)		(9-55)	

\*Heading Only - No Data Entry

Figure 9-7 (Cont'd). PCM Measurement Description Group (D).



**TABLE 9-6. PCM MEASUREMENT DESCRIPTION GROUP (D)**

<b>PARAMETER</b>	<b>MAXIMUM FIELD SIZE</b>	<b>CODE NAME</b>	<b>DEFINITION</b>
DATA LINK NAME	32	D-x\DLN	PROVIDE THE DATA LINK NAME.
NUMBER OF MEASUREMENT LISTS	2	D-x\ML\N	SPECIFY THE NUMBER OF MEASUREMENT LISTS TO BE PROVIDED.
MEASUREMENT LIST NAME	32	D-x\MLN-y	PROVIDE THE MEASUREMENT LIST NAME ASSOCIATED WITH THE FOLLOWING ATTRIBUTES. THE FOLLOWING INFORMATION WILL HAVE TO BE REPEATED FOR EACH MEASUREMENT LIST IDENTIFIED IN THE PCM FORMAT ATTRIBUTES GROUP.
NUMBER OF MEASURANDS	4	D-x\MN\N-y	SPECIFY THE NUMBER OF MEASURANDS INCLUDED WITHIN THIS MEASUREMENT LIST.
MEASUREMENT NAME	32	D-x\MN-y-n	MEASURAND NAME.
PARITY	2	D-x\MN1-y-n	SPECIFY PARITY: EVEN- 'EV'; ODD - 'OD'; NONE - 'NO' DEFAULT TO MINOR FRAME DEFINITION - 'DE'
PARITY TRANSFER ORDER	1	D-x\MN2-y-n	PARITY BIT LOCATION: LEADS WORD - 'L' TRAILS WORD - 'T' MINOR FRAME DEFAULT - 'D'
MEASUREMENT TRANSFER ORDER	1	D-x\MN3-y-n	MOST SIGNIFICANT BIT FIRST - 'M' LEAST SIGNIFICANT BIT FIRST - 'L' DEFAULT - 'D'

<b>TABLE 9-6 (Cont'd). PCM MEASUREMENT DESCRIPTION GROUP (D)</b>			
<b>PARAMETER</b>	<b>MAXIMUM FIELD SIZE</b>	<b>CODE NAME</b>	<b>DEFINITION</b>
<b>MEASUREMENT LOCATION</b>			
MEASUREMENT LOCATION TYPE	4	D-x\LT-y-n	SPECIFY THE NATURE OF THE LOCATION OF THIS MEASURAND. MINOR FRAME - 'MF' MINOR FRAME SUPERCOMMUTATED - 'MFSC' MINOR FRAME FRAGMENTED - 'MFFR' SUBFRAME - 'SF' SUBFRAME SUPERCOMMUTATED - 'SFSC' SUBFRAME FRAGMENTED - 'SFFR' WORD AND FRAME - 'WDFR'
<b>MINOR FRAME</b>			
MINOR FRAME LOCATION	4	D-x\MF-y-n	THE MINOR FRAME WORD POSITION OF THE MEASUREMENT.
BIT MASK	64	D-x\MFM-y-n	BINARY STRING OF 1s AND 0s TO IDENTIFY THE BITS IN A WORD LOCATION THAT ARE ASSIGNED TO THIS MEASUREMENT. IF THE FULL WORD IS USED FOR THIS MEASUREMENT, ENTER - 'FW'. LEFT-MOST BIT CORRESPONDS TO FIRST BIT TRANSMITTED.
<b>MINOR FRAME SUPERCOMMUTATED</b>			
NUMBER OF MINOR FRAME LOCATIONS	4	D-x\MFS\N-y-n	NUMBER OF WORD POSITIONS THAT THE SUPERCOMMUTATED CHANNEL OCCUPIES, N.
LOCATION DEFINITION	1	D-x\MFS1-y-n	TO SPECIFY: INTERVAL, ENTER - 'I' EVERY WORD LOCATION, ENTER - 'E'
<b>INTERVAL</b>			
LOCATION IN MINOR FRAME	4	D-x\MFS2-y-n	SPECIFY THE FIRST WORD LOCATION IN THE MINOR FRAME.

<b>TABLE 9-6 (Cont'd). PCM MEASUREMENT DESCRIPTION GROUP (D)</b>			
<b>PARAMETER</b>	<b>MAXIMUM FIELD SIZE</b>	<b>CODE NAME</b>	<b>DEFINITION</b>
BIT MASK	64	D-x\ MFS3-y-n	BINARY STRING OF 1s AND 0s TO IDENTIFY THE BITS IN A WORD LOCATION THAT ARE ASSIGNED TO THIS SUPERCOMMUTATED MEASUREMENT. IF THE FULL WORD IS USED FOR THIS MEASUREMENT, ENTER - 'FW'. LEFT-MOST BIT CORRESPONDS TO FIRST BIT TRANSMITTED.
INTERVAL	3	D-x\ MFS4-y-n	SPECIFY THE INTERVAL COUNT THAT IS THE OFFSET FROM THE FIRST WORD LOCATION AND EACH SUBSEQUENT LOCATION.
<b>EVERY LOCATION</b>			
MINOR FRAME LOCATION	4	D-x\ MFSW-y-n-e	ENTER THE MINOR FRAME WORD POSITION OF THE MEASUREMENT.
BIT MASK	64	D-x\ MFSM-y-n-e	BINARY STRING OF 1s AND 0s TO IDENTIFY THE BITS IN A WORD LOCATION THAT ARE ASSIGNED TO THIS SUPERCOMMUTATED MEASUREMENT. IF THE FULL WORD IS USED FOR THE MEASUREMENT, ENTER - 'FW'. LEFT-MOST BIT CORRESPONDS TO FIRST BIT TRANSMITTED.
<b>NOTE:</b> ENTER THE MINOR FRAME LOCATION AND BIT MASK FOR EACH OF THE WORD POSITIONS THAT THE SUPERCOMMUTATED CHANNEL OCCUPIES, (N) LOCATIONS.			
<b>MINOR FRAME FRAGMENTED</b>			
NUMBER OF FRAGMENTS	1	D-x\ FMF\N-y-n	NUMBER OF MINOR FRAME WORD POSITIONS THAT THE FRAGMENTED CHANNEL OCCUPIES, N.
MEASUREMENT WORD LENGTH	3	D-x\ FMF1-y-n	TOTAL LENGTH OF THE RECONSTRUCTED BINARY DATA WORD

<b>TABLE 9-6 (Cont'd). PCM MEASUREMENT DESCRIPTION GROUP (D)</b>			
<b>PARAMETER</b>	<b>MAXIMUM FIELD SIZE</b>	<b>CODE NAME</b>	<b>DEFINITION</b>
LOCATION DEFINITION	1	D-x\ FMF2-y-n	TO SPECIFY: INTERVAL, ENTER - 'I' EVERY WORD LOCATION, ENTER - 'E'
<b>INTERVAL</b>			
LOCATION IN MINOR FRAME	4	D-x\ FMF3-y-n	SPECIFY THE FIRST WORD POSITION THAT THE FRAGMENTED WORD OCCUPIES IN THE MINOR FRAME.
BIT MASK	64	D-x\ FMF4-y-n	BINARY STRING OF 1s AND 0s TO IDENTIFY THE BITS IN A WORD POSITION THAT ARE ASSIGNED TO THIS FRAGMENTED CHANNEL. IF THE FULL WORD IS USED FOR THIS MEASUREMENT, ENTER 'FW'. LEFT-MOST BIT CORRESPONDS TO FIRST BIT TRANSMITTED.
INTERVAL	4	D-x\ FMF5-y-n	SPECIFY THE INTERVAL THAT IS THE OFFSET FROM THE FIRST WORD LOCATION AND EACH SUBSEQUENT LOCATION.
<b>EVERY LOCATION</b>			
MINOR FRAME LOCATION	4	D-x\ FMF6-y-n-e	ENTER THE MINOR FRAME WORD POSITION OF THE MEASUREMENT.
BIT MASK	64	D-x\ FMF7-y-n-e	BINARY STRING OF 1s AND 0s TO IDENTIFY THE BITS IN A WORD POSITION THAT ARE ASSIGNED TO THIS FRAGMENTED MEASUREMENT. IF THE FULL WORD IS USED FOR THIS MEASUREMENT, ENTER - 'FW'. LEFT-MOST BIT CORRESPONDS TO FIRST BIT TRANSMITTED.
FRAGMENT TRANSFER ORDER	1	D-x\ FMF8-y-n-e	MOST SIGNIFICANT BIT FIRST - 'M' LEAST SIGNIFICANT BIT FIRST - 'L' DEFAULT - 'D'

**TABLE 9-6 (Cont'd). PCM MEASUREMENT DESCRIPTION GROUP (D)**

PARAMETER	MAXIMUM FIELD SIZE	CODE NAME	DEFINITION
FRAGMENT POSITION	1	D-x\FMF9-y-n-e	A NUMBER FROM 1 TO N SPECIFYING THE POSITION OF THIS FRAGMENT WITHIN THE RECONSTRUCTED BINARY DATA WORD. (1 CORRESPONDS TO THE MOST SIGNIFICANT FRAGMENT.)
<b>NOTE:</b> ENTER THE MINOR FRAME LOCATION AND BIT MASK FOR EACH OF THE WORD POSITIONS THAT THE FRAGMENTED CHANNEL OCCUPIES, (N) LOCATIONS.			
<b>SUBFRAME</b>			
SUBFRAME NAME	32	D-x\SF1-y-n	ENTER THE SUBFRAME NAME.
LOCATION IN SUBFRAME	3	D-x\SF2-y-n	SPECIFY THE WORD NUMBER IN THE SUBFRAME.
BIT MASK	64	D-x\SFM-y-n	BINARY STRING OF 1s AND 0s TO IDENTIFY THE BITS IN A WORD LOCATION THAT ARE ASSIGNED TO THIS MEASUREMENT. IF THE FULL WORD IS USED FOR THE MEASUREMENT, ENTER - 'FW'. LEFT-MOST BIT CORRESPONDS TO FIRST BIT TRANSMITTED.
<b>SUBFRAME SUPERCOMMUTATED</b>			
SUBFRAME NAME	32	D-x\SFS1-y-n	ENTER THE SUBFRAME NAME.
NUMBER OF SUBFRAME LOCATIONS	3	D-x\SFS\N-y-n	NUMBER OF SUBFRAME WORD POSITIONS THAT THE SUPERCOMMUTATED CHANNEL OCCUPIES.
LOCATION DEFINITION	1	D-x\SFS2-y-n	TO SPECIFY: INTERVAL , ENTER - 'I' EVERY WORD LOCATION, ENTER - 'E'
<b>INTERVAL</b>			
LOCATION IN SUBFRAME	3	D-x\SFS3-y-n	SPECIFY THE FIRST WORD POSITION THAT THE SUPERCOMMUTATED WORD OCCUPIES IN THE SUBFRAME.

<b>TABLE 9-6 (Cont'd). PCM MEASUREMENT DESCRIPTION GROUP (D)</b>			
<b>PARAMETER</b>	<b>MAXIMUM FIELD SIZE</b>	<b>CODE NAME</b>	<b>DEFINITION</b>
BIT MASK	64	D-x\ SFS4-y-n	BINARY STRING OF 1s AND 0s TO IDENTIFY THE BIT LOCATIONS IN A WORD POSITION THAT ARE ASSIGNED TO THIS SUPER-COMMUTATED CHANNEL. IF THE FULL WORD IS USED FOR THIS MEASUREMENT, ENTER - 'FW'. LEFT-MOST BIT CORRESPONDS TO FIRST BIT TRANSMITTED.
INTERVAL	3	D-x\ SFS5-y-n	SPECIFY THE INTERVAL THAT IS THE OFFSET FROM THE FIRST WORD LOCATION AND EACH SUBSEQUENT LOCATION.
<b>EVERY LOCATION</b>			
SUBFRAME LOCATION	3	D-x\ SFS6-y-n-e	ENTER THE SUBFRAME WORD POSITION OF THE MEASUREMENT.
BIT MASK	64	D-x\ SFS7-y-n-e	BINARY STRING OF 1s AND 0s TO IDENTIFY THE BIT LOCATIONS IN A WORD POSITION THAT ARE ASSIGNED TO THIS SUPER-COMMUTATED MEASUREMENT. IF THE FULL WORD IS USED FOR THIS MEASUREMENT, ENTER 'FW'. LEFT-MOST BIT CORRESPONDS TO FIRST BIT TRANSMITTED.
<b>NOTE:</b> ENTER THE SUBFRAME LOCATION AND BIT MASK FOR EACH OF THE WORD POSITIONS THAT THE SUPERCOMMUTATED CHANNEL OCCUPIES, (N) LOCATIONS.			
<b>SUBFRAME FRAGMENTED</b>			
NUMBER OF FRAGMENTS	1	D-x\ FSF\ N-y-n	NUMBER OF SUBFRAME WORD POSITIONS THAT THE FRAGMENTED CHANNEL OCCUPIES, N.
MEASUREMENT WORD LENGTH	3	D-x\ FSF1-y-n	TOTAL LENGTH OF THE RECONSTRUCTED BINARY DATA WORD
NUMBER OF SUBFRAMES	1	D-x\ FSF2\ N-y-n	NUMBER OF SUBFRAMES CONTAINING THE FRAGMENTS
SUBFRAME NAME	32	D-x\ FSF3-y-n-m	ENTER THE SUBFRAME NAME.

**TABLE 9-6 (Cont'd). PCM MEASUREMENT DESCRIPTION GROUP (D)**

PARAMETER	MAXIMUM FIELD SIZE	CODE NAME	DEFINITION
LOCATION DEFINITION	1	D-x\FSF4-y-n-m	TO SPECIFY: INTERVAL, ENTER - 'I' EVERY WORD LOCATION, ENTER - 'E'
<b>INTERVAL</b>			
LOCATION IN SUBFRAME	3	D-x\FSF5-y-n-m	SPECIFY THE FIRST WORD POSITION THAT THE FRAGMENTED WORD OCCUPIES IN THE SUBFRAME.
BIT MASK	64	D-x\FSF6-y-n-m	BINARY STRING OF 1s AND 0s TO IDENTIFY THE BIT LOCATIONS IN A WORD POSITION THAT ARE ASSIGNED TO THIS FRAGMENTED CHANNEL. IF THE FULL WORD IS USED FOR THIS MEASUREMENT, ENTER - 'FW'. LEFT-MOST BIT CORRESPONDS TO FIRST BIT TRANSMITTED.
INTERVAL	3	D-x\FSF7-y-n-m	SPECIFY THE INTERVAL THAT IS THE OFFSET FROM THE FIRST WORD LOCATION AND EACH SUBSEQUENT LOCATION.
<b>EVERY LOCATION</b>			
SUBFRAME LOCATION	3	D-x\FSF8-y-n-m-e	ENTER THE SUBFRAME WORD POSITION OF THE MEASUREMENT.
BIT MASK	64	D-x\FSF9-y-n-m-e	BINARY STRING OF 1s AND 0s TO IDENTIFY THE BIT LOCATIONS IN A WORD POSITION THAT IS ASSIGNED TO THIS FRAGMENTED MEASUREMENT. IF THE FULL WORD IS USED FOR THIS MEASUREMENT, ENTER 'FW'. LEFT-MOST BIT CORRESPONDS TO FIRST BIT TRANSMITTED.
FRAGMENT TRANSFER ORDER	1	D-x\FSF10-y-n-m-e	MOST SIGNIFICANT BIT FIRST - 'M' LEAST SIGNIFICANT BIT FIRST - 'L' DEFAULT - 'D'

**TABLE 9-6 (Cont'd). PCM MEASUREMENT DESCRIPTION GROUP (D)**

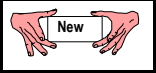
PARAMETER	MAXIMUM FIELD SIZE	CODE NAME	DEFINITION
FRAGMENT POSITION	1	D-x\FSF11-y-n-m-e	A NUMBER FROM 1 TO N SPECIFYING THE POSITION OF THIS FRAGMENT WITHIN THE RECONSTRUCTED BINARY DATA WORD. (1 CORRESPONDS TO THE MOST SIGNIFICANT FRAGMENT.)
<p><b>NOTE:</b> ENTER THE SUBFRAME LOCATION AND BIT MASK FOR EACH OF THE WORD POSITIONS THAT THE FRAGMENTED CHANNEL OCCUPIES, (N) LOCATIONS.</p> <p><b>NOTE:</b> REPEAT THE ABOVE ENTRIES, AS APPROPRIATE FOR EACH SUBFRAME THAT CONTAINS THE COMPONENTS OF THE FRAGMENTED WORD.</p>			
<b>WORD AND FRAME</b>			
NUMBER OF MEASUREMENT LOCATIONS	4	D-x\MML\N-y-n	SPECIFY THE NUMBER OF LOCATIONS TO BE DEFINED FOR THIS MEASUREMENT.
NUMBER OF FRAGMENTS	1	D-x\MNF\N-y-n-m	NUMBER OF WORD POSITIONS THAT EACH FRAGMENTED MEASUREMENT LOCATION OCCUPIES, N. ENTER "1" IF THIS MEASUREMENT IS NOT FRAGMENTED.
MEASUREMENT WORD LENGTH	3	D-x\MWL-y-n-m	TOTAL LENGTH OF THE RECONSTRUCTED BINARY DATA WORD
WORD POSITION	4	D-x\WP-y-n-m-e	SPECIFY THE MINOR FRAME WORD POSITION OF THIS MEASUREMENT LOCATION OR FRAGMENT.
WORD INTERVAL	4	D-x\WI-y-n-m-e	SPECIFY THE INTERVAL THAT IS THE OFFSET FROM THE FIRST WORD POSITION AND EACH SUBSEQUENT WORD POSITION. AN INTERVAL OF ZERO INDICATES THAT THERE IS ONLY ONE WORD POSITION BEING DEFINED.



**TABLE 9-6 (Cont'd). PCM MEASUREMENT DESCRIPTION GROUP (D)**

PARAMETER	MAXIMUM FIELD SIZE	CODE NAME	DEFINITION
FRAME POSITION	3	D-x\ FP-y-n-m-e	SPECIFY THE FRAME LOCATION OF THIS MEASUREMENT LOCATION OR FRAGMENT.
FRAME INTERVAL	3	D-x\ FI-y-n-m-e	SPECIFY THE INTERVAL THAT IS THE OFFSET FROM THE FIRST FRAME LOCATION AND EACH SUBSEQUENT FRAME LOCATION. AN INTERVAL OF ZERO INDICATES THAT THERE IS ONLY ONE FRAME LOCATION BEING DEFINED.
BIT MASK	64	D-x\ WFM-y-n-m-e	BINARY STRING OF 1S AND 0S TO IDENTIFY THE BIT LOCATIONS USED IN EACH MEASUREMENT LOCATION OR FRAGMENT. IF THE FULL WORD IS USED, ENTER 'FW'. LEFT-MOST BIT CORRESPONDS TO FIRST BIT TRANSMITTED.
FRAGMENT TRANSFER ORDER	1	D-x\ WFT-y-n-m-e	MOST SIGNIFICANT BIT FIRST – 'M' LEAST SIGNIFICANT BIT FIRST – 'L' DEFAULT – 'D'
FRAGMENT POSITION	1	D-x\ WFP-y-n-m-e	A NUMBER FROM 1 TO N SPECIFYING THE POSITION OF THIS FRAGMENT WITHIN THE RECONSTRUCTED BINARY DATA WORD. (1 CORRESPONDS TO MOST SIGNIFICANT FRAGMENT.)
<b>NOTE:</b> MEASUREMENT WORD LENGTH, FRAGMENT TRANSFER ORDER AND FRAGMENT POSITION ATTRIBUTES DO NOT APPLY WHEN THE "NUMBER OF FRAGMENTS" ATTRIBUTE FOR A MEASUREMENT IS 1.			
<b>COMMENTS</b>			
COMMENTS	3200	D-x\ COM	PROVIDE THE ADDITIONAL INFORMATION REQUESTED OR ANY OTHER INFORMATION DESIRED.

**TABLE 9-6 (Cont'd). PCM MEASUREMENT DESCRIPTION GROUP (D)**

**NOTE:** THIS GROUP WILL CONTAIN A REPETITION OF THE ABOVE INFORMATION UNTIL EACH MEASUREMENT HAS BEEN DEFINED. ANY WORD POSITION NOT INCLUDED WILL BE TREATED AS A SPARE CHANNEL OR A "DON'T CARE" CHANNEL. INFORMATION WILL NOT BE PROCESSED FOR THESE "SPARE" CHANNELS. NOTE THAT MEASUREMENT LIST CHANGES AND FORMAT CHANGES THAT ARE A PART OF CLASS II SYSTEMS ARE INCLUDED IN THE ABOVE, SINCE THE KEY TO THE MEASUREMENT DEFINITION IS THE DATA LINK NAME (FORMAT) AND THE MEASUREMENT LIST.

9.5.6.3 Bus Data Attributes (B). Figure 9-8 and Table 9-7 describe bus-originated data formats. The Bus Data Attributes Group defines the attributes of a MIL-STD-1553 data acquisition system that is compliant with Chapter 8 or an ARINC 429 data acquisition system that is consistent with the Aeronautical Radio Inc. specification of ARINC 429 bus data. The primary components of this group are the recording description and message content definition. The former defines the method by which the data were recorded on the tape such as track spread versus composite. The latter consists of the message identification information and the measurement description set. The message identification information defines the contents of the control word that identifies each bus message. The measurement description set describes the measurement attributes and contains the measurement name that links the measurand to the Data Conversion Attributes Group (C).

Mode codes are described in the message identification information. If the Subterminal Address (STA) field contains 00000 or 11111, the information in the Data Word Count/Mode Code field is a mode code and identifies the function of the mode code. If the mode code has associated data words, they are described in this section of the attributes. If the bus message is a remote terminal to remote terminal transfer, both the transmit command and the receive command are used to identify the message.

<b>Bus Data Attributes Group (B)</b>		CODE NAME	REFERENCE PAGE
<b>DATA LINK NAME</b>		(B-x)\DLN)	(9-59)
	TEST ITEM	(B-x)\TA)	
	NUMBER OF BUSES	(B-x)\NBS\N)	
	BUS NUMBER	(B-x)\BID-i)	
	BUS NAME	(B-x)\BNA-i)	
	BUS TYPE	(B-x)\BT-i)	
	*RECORDING DESCRIPTION		(9-59)
	NUMBER OF TRACKS	(B-x)\TK\N-i)	
	TRACK SEQUENCE	(B-x)\TS-i-k)	
	*MESSAGE CONTENT DEFINITION		(9-60)
	NUMBER OF MESSAGES	(B-x)\NMS\N-i)	
	MESSAGE NUMBER	(B-x)\MID-i-n)	
	MESSAGE NAME	(B-x)\MNA-i-n)	
	REMOTE TERMINAL NAME	(B-x)\TRN-i-n)	
	REMOTE TERMINAL ADDRESS	(B-x)\TRA-i-n)	
	SUBTERMINAL NAME	(B-x)\STN-i-n)	
	SUBTERMINAL ADDRESS	(B-x)\STA-i-n)	
	TRANSMIT/RECEIVE MODE	(B-x)\TRM-i-n)	
	DATA WORD COUNT/MODE CODE	(B-x)\DWC-i-n)	
	SPECIAL PROCESSING	(B-x)\SPR-i-n)	
	*ARINC 429 MESSAGE DEFINITION		(9-61)
	ARINC 429 LABEL	(B-x)\LBL-i-n)	
	ARINC 429 SDI CODE	(B-x)\SDI-i-n)	
	*RT/RT RECEIVE COMMAND LIST		(9-61)
	REMOTE TERMINAL NAME	(B-x)\RTRN-i-n-m)	
	REMOTE TERMINAL ADDRESS	(B-x)\RTRA-i-n-m)	
	SUBTERMINAL NAME	(B-x)\RSTN-i-n-m)	
	SUBTERMINAL ADDRESS	(B-x)\RSTA-i-n-m)	
	DATA WORD COUNT	(B-x)\RDWC-i-n-m)	
	*MODE CODE		(9-62)
	MODE CODE DESCRIPTION	(B-x)\MCD-i-n)	
	MODE CODE DATA WORD DESCRIPTION	(B-x)\MCW-i-n)	
	*MEASUREMENT DESCRIPTION SET		(9-62)
	NUMBER OF MEASURANDS	(B-x)\MN\N-i-n)	
	MEASUREMENT NAME	(B-x)\MN-i-n-p)	
	PARITY	(B-x)\MN1-i-n-p)	
	PARITY TRANSFER ORDER	(B-x)\MN2-i-n-p)	

(continued on next page)

Figure 9-8. Bus Data Attributes Group (B).

		*MEASUREMENT LOCATION	(9-62)
		NUMBER OF MEASUREMENT LOCATIONS	(B-x)\NML\N-i-n-p)
		MESSAGE WORD NUMBER	(B-x)\MWN-i-n-p-e)
		BIT MASK	(B-x)\MBM-i-n-p-e)
		TRANSFER ORDER	(B-x)\MTO-i-n-p-e)
		FRAGMENT POSITION	(B-x)\MFP-i-n-p-e)
	*COMMENTS		
	COMMENTS	(B-x)\COM)	(9-63)
<b>*Heading Only – No Data Entry</b>			

Figure 9-8 (Cont'd). Bus Data Attributes Group (B).

**TABLE 9-7. BUS DATA ATTRIBUTES GROUP (B)**

PARAMETER	MAXIMUM FIELD SIZE	CODE NAME	DEFINITION
DATA LINK NAME	32	B-x\DLN	IDENTIFY THE DATA LINK NAME CONSISTENT WITH THE MULTIPLEX/MODULATION GROUP. THE PCM FORMAT OF THE DATA STREAM SHALL BE DEFINED IN THE PCM FORMAT ATTRIBUTES GROUP.
TEST ITEM	16	B-x\TA	TEST ITEM DESCRIPTION IN TERMS OF NAME, MODEL, PLATFORM, OR IDENTIFICATION CODE THAT CONTAINS THE DATA ACQUISITION SYSTEM.
NUMBER OF BUSES	1	B-x\NBS\N	SPECIFY THE NUMBER OF BUSES INCLUDED WITHIN THIS DATA LINK.
BUS NUMBER	3	B-x\BID-i	ENTER THE BUS NUMBER AS A BINARY STRING.
BUS NAME	32	B-x\BNA-i	SPECIFY THE BUS NAME.
BUS TYPE	8	B-x\BT-i	SPECIFY THE BUS TYPE: 1553 BUS – ‘1553’ ARINC 429 BUS – ‘A429’
<b>RECORDING DESCRIPTION</b>			
NUMBER OF TRACKS	2	B-x\TK\N-i	ENTER THE NUMBER OF TAPE TRACKS USED TO RECORD DATA. ANY ENTRY GREATER THAN ONE INDICATES THAT THE DATA HAS BEEN SPREAD ACROSS MULTIPLE TRACKS.
TRACK SEQUENCE	3	B-x\TS-i-k	IN THESE ENTRIES, GIVE THE SEQUENCE ORDER OF TAPE TRACKS THAT SHOULD BE USED TO RECOVER THE DATA STREAM IN THE CORRECT ORDER. (THE ORDER GIVEN SHOULD CORRESPOND TO THE ACTUAL SKEW OF THE DATA ON THE TAPE.)



**TABLE 9-7 (Cont'd). BUS DATA ATTRIBUTES GROUP (B)**

PARAMETER	MAXIMUM FIELD SIZE	CODE NAME	DEFINITION
<b>MESSAGE CONTENT DEFINITION</b>			
NUMBER OF MESSAGES	8	B-x\NMS\N-i	THE NUMBER OF MESSAGES TO BE DEFINED.
MESSAGE NUMBER	8	B-x\MID-i-n	THE MESSAGE NUMBER THAT CONTAINS THE FOLLOWING DATA.
MESSAGE NAME	32	B-x\MNA-i-n	SPECIFY THE MESSAGE NAME.
REMOTE TERMINAL NAME	32	B-x\TRN-i-n	ENTER THE NAME OF THE REMOTE TERMINAL THAT IS SENDING OR RECEIVING THIS MESSAGE. FOR RT/RT, SPECIFY THE SENDING REMOTE TERMINAL NAME.
REMOTE TERMINAL ADDRESS	5	B-x\TRA-i-n	SPECIFY THE FIVE BIT REMOTE TERMINAL ADDRESS FOR THIS MESSAGE.
SUBTERMINAL NAME	32	B-x\STN-i-n	ENTER THE NAME OF THE SUBTERMINAL THAT IS SENDING OR RECEIVING THIS MESSAGE.
SUBTERMINAL ADDRESS	5	B-x\STA-i-n	SPECIFY THE FIVE BIT SUBTERMINAL ADDRESS FOR THIS MESSAGE.
TRANSMIT/RECEIVE MODE	1	B-x\TRM-i-n	INDICATE IF THIS COMMAND WORD IS A TRANSMIT OR RECEIVE COMMAND. FOR RT/RT, SPECIFY TRANSMIT. TRANSMIT - '1' RECEIVE - '0'
DATA WORD COUNT/MODE CODE	5	B-x\DWC-i-n	ENTER THE NUMBER OF DATA WORDS AS A BINARY STRING, USING 'X' TO INDICATE A "DON'T CARE" VALUE. IF THE SUBTERMINAL ADDRESS INDICATES A MODE CODE, ENTER THE MODE CODE VALUE AS A BINARY STRING.

**TABLE 9-7 (Cont'd). BUS DATA ATTRIBUTES GROUP (B)**

PARAMETER	MAXIMUM FIELD SIZE	CODE NAME	DEFINITION
SPECIAL PROCESSING	200	B-x\SPR-i-n	PROVIDE ANY SPECIAL PROCESSING REQUIREMENTS PERTAINING TO THIS MESSAGE.
<b>ARINC 429 MESSAGE DEFINITION</b>			
ARINC 429 LABEL	8	B-x\LBL-i-n	SPECIFY THE EIGHT-BIT ARINC 429 LABEL FOR THIS MESSAGE.
ARINC 429 SDI CODE	3	B-x\SDI-i-n	SPECIFY THE TWO-BIT ARINC 429 SDI CODE FOR THIS MESSAGE: ALL SDI – ‘ALL’ SDI CODE 0 – ‘0’ SDI CODE 1 – ‘1’ SDI CODE 2 – ‘2’ SDI CODE 3 – ‘3’
<b>RT/RT RECEIVE COMMAND LIST</b>			
REMOTE TERMINAL NAME	32	B-x\ RTRN-i-n-m	ENTER THE NAME OF THE REMOTE TERMINAL THAT IS RECEIVING THIS RT/RT MESSAGE.
REMOTE TERMINAL ADDRESS	5	B-x\ RTRA-i-n-m	SPECIFY THE FIVE BIT REMOTE TERMINAL ADDRESS FOR THIS RT/RT MESSAGE.
SUBTERMINAL NAME	32	B-x\ RSTN-i-n-m	ENTER THE NAME OF THE SUB-TERMINAL THAT IS RECEIVING THIS RT/RT MESSAGE.
SUBTERMINAL ADDRESS	5	B-x\ RSTA-i-n-m	SPECIFY THE FIVE BIT SUBTERMINAL ADDRESS FOR THIS RT/RT MESSAGE.
DATA WORD COUNT	5	B-x\ RDWC-i-n-m	ENTER THE NUMBER OF DATA WORDS AS A BINARY STRING, USING ‘X’ TO INDICATE A “DON’T CARE” VALUE. EXCLUDE STATUS AND TIME WORDS. (AN RT/RT MESSAGE CANNOT CONTAIN A MODE CODE.)

**TABLE 9-7 (Cont'd). BUS DATA ATTRIBUTES GROUP (B)**

PARAMETER	MAXIMUM FIELD SIZE	CODE NAME	DEFINITION
<b>MODE CODE</b>			
MODE CODE DESCRIPTION	200	B-x\MCD-i-n	DESCRIBE THE FUNCTION OR ACTION ASSOCIATED WITH THIS MODE CODE.
MODE CODE DATA WORD DESCRIPTION	200	B-x\MCW-i-n	IF THE MODE CODE HAS AN ASSOCIATED DATA WORD FOLLOWING THE MODE CODE COMMAND, PROVIDE A COMPLETE DESCRIPTION OF THE DATA WORD.
<b>MEASUREMENT DESCRIPTION SET</b>			
NUMBER OF MEASURANDS	4	B-x\MN\N-i-n	SPECIFY THE NUMBER OF MEASURANDS.
MEASUREMENT NAME	32	B-x\MN-i-n-p	MEASURAND NAME.
PARITY	2	B-x\MN1-i-n-p	NORMAL WORD PARITY. EVEN - 'EV'                      ODD - 'OD' NONE - 'NO'
PARITY TRANSFER ORDER	1	B-x\MN2-i-n-p	PARITY BIT LOCATION LEADS WORD - 'L' TRAILS WORD - 'T'
<b>MEASUREMENT LOCATION</b>			
NUMBER OF MEASUREMENT LOCATIONS	2	B-x\NML\N-i-n-p	IF THIS MEASUREMENT IS CONTAINED IN ONE WORD, ENTER '1'. IF THIS MEASUREMENT IS FRAGMENTED, ENTER THE NUMBER OF FRAGMENTS.
MESSAGE WORD NUMBER	3	B-x\MWN-i-n-p-e	ENTER THE DATA WORD NUMBER WITHIN A MESSAGE THAT CONTAINS THE MEASUREMENT OR THE FRAGMENTED MEASURAND.



**TABLE 9-7 (Cont'd). BUS DATA ATTRIBUTES GROUP (B)**

<b>PARAMETER</b>	<b>MAXIMUM FIELD SIZE</b>	<b>CODE NAME</b>	<b>DEFINITION</b>
BIT MASK	64	B-x\MBM-i-n-p-e	BINARY STRING OF 1s AND 0s TO IDENTIFY THE BIT LOCATIONS THAT ARE ASSIGNED TO THIS MEASUREMENT IN THE WORD IDENTIFIED ABOVE. IF THE FULL WORD IS USED FOR THIS MEASUREMENT, ENTER 'FW'. LEFT-MOST BIT CORRESPONDS TO FIRST BIT TRANSMITTED.
TRANSFER ORDER	3	B-x\MTO-i-n-p-e	SPECIFY IF THE START BIT IS MOST SIGNIFICANT - 'MSB' LEAST SIGNIFICANT - 'LSB'
FRAGMENT POSITION	1	B-x\MFP-i-n-p-e	A NUMBER FROM 1 TO N SPECIFYING THE POSITION OF THIS FRAGMENT WITHIN THE RECONSTRUCTED BINARY DATA WORD. (1 CORRESPONDS TO THE MOST SIGNIFICANT FRAGMENT.)
<p><b>NOTE:</b> REPEAT THE ABOVE TO DESCRIBE EACH FRAGMENT OF A FRAGMENTED WORD. THE TRANSFER ORDER INDICATES WHETHER TO TRANSPOSE THE ORDER OF THE BIT SEQUENCE OR NOT (LSB INDICATES TO TRANSPOSE THE BIT SEQUENCE).</p>			
<b>COMMENTS</b>			
COMMENTS	3200	B-x\COM	PROVIDE THE ADDITIONAL INFORMATION REQUESTED OR ANY OTHER INFORMATION DESIRED.

9.5.7 PAM Attributes (A). This group provides the information necessary to define the channelization and measurand definition for a PAM waveform. As with the PCM signal, the tie to the calibration data is with the measurement name. Figure 9-9 summarizes the types of inputs required. Table 9-8 specifies the details required. The information that defines the measurand for each channel is required for the channels of interest.

<b>DATA LINK NAME</b>	<b><u>PAM Attributes Group (A)</u></b>	<b>CODE NAME</b>	<b>REFERENCE PAGE</b>
		(A-x\DLN)	(9-65)
	INPUT CODE	(A-x\A1)	
	POLARITY	(A-x\A2)	
	SYNC PATTERN TYPE	(A-x\A3)	
	SYNC PATTERN (OTHER)	(A-x\A4)	
	CHANNEL RATE	(A-x\A5)	
	CHANNELS PER FRAME	(A-x\A\N)	
	NUMBER OF MEASURANDS	(A-x\A\MN\N)	
	*REFERENCE CHANNELS		(9-66)
	0% SCALE CHANNEL NUMBER	(A-x\RC1)	
	50% SCALE CHANNEL NUMBER	(A-x\RC2)	
	FULL SCALE CHANNEL NUMBER	(A-x\RC3)	
	*SUBFRAME DEFINITION		(9-66)
	NUMBER OF SUBFRAMES	(A-x\SF\N)	
	SUBFRAME n LOCATION	(A-x\SF1-n)	
	SUBFRAME n SYNCHRONIZATION	(A-x\SF2-n)	
	SUBFRAME n SYNCHRONIZATION PATTERN	(A-x\SF3-n)	
	*CHANNEL ASSIGNMENT		(9-67)
	MEASUREMENT NAME	(A-x\MN1-n)	
	SUBCOM	(A-x\MN2-n)	
	SUPERCOM	(A-x\MN3-n)	
	*LOCATION		(9-67)
	CHANNEL NUMBER	(A-x\LCW-n-s)	
	SUBFRAME CHANNEL NUMBER	(A-x\LCN-n-s-r)	
	*COMMENTS		
	COMMENTS	(A-x\COM)	(9-67)

\*Heading Only – No Data Entry

Figure 9-9. PAM Attributes Group (A).

**TABLE 9-8. PAM ATTRIBUTES GROUP (A)**

<b>PARAMETER</b>	<b>MAXIMUM FIELD SIZE</b>	<b>CODE NAME</b>	<b>DEFINITION</b>
DATA LINK NAME	32	A-x\DLN	IDENTIFY THE DATA LINK NAME.
INPUT CODE	2	A-x\A1	DEFINE THE INPUT CODE: 50% DUTY CYCLE - 'RZ' 100% DUTY CYCLE (NRZ) - 'NR'
POLARITY	1	A-x\A2	NORMAL - 'N'    INVERTED - 'I'
SYNC PATTERN TYPE	3	A-x\A3	SPECIFY THE SYNCHRONIZATION PATTERN IRIG 106 - 'STD' OTHER - 'OTH'
SYNC PATTERN (OTHER)	5	A-x\A4	DEFINE THE OTHER (NONSTANDARD) SYNCHRONIZATION PATTERN IN TERMS OF: 0 – ZERO SCALE H – HALF SCALE F – FULL SCALE X – DON'T CARE
CHANNEL RATE	6	A-x\A5	SPECIFY THE CHANNEL RATE IN CHANNELS PER SECOND.
CHANNELS PER FRAME	3	A-x\A\N	SPECIFY THE NUMBER OF CHANNELS PER FRAME INCLUDING THE SYNC PATTERN AND CALIBRATION CHANNELS. MAXIMUM ALLOWED IS 128.
NUMBER OF MEASURANDS	4	A-x\A\MN\N	INDICATE THE NUMBER OF MEASURANDS ASSOCIATED WITH THIS DATA LINK (SOURCE).

**TABLE 9-8 (Cont'd). PAM ATTRIBUTES GROUP (A)**

PARAMETER	MAXIMUM FIELD SIZE	CODE NAME	DEFINITION
<b>REFERENCE CHANNELS</b>			
0% SCALE CHANNEL NUMBER	3	A-x\RC1	CHANNEL NUMBER OF 0% SCALE REFERENCE. IF NOT USED, ENTER 'NON' (NONE).
50% SCALE CHANNEL NUMBER	3	A-x\RC2	CHANNEL NUMBER OF 50% SCALE REFERENCE. IF NOT USED, ENTER 'NON' (NONE).
FULL SCALE CHANNEL NUMBER	3	A-x\RC3	CHANNEL NUMBER OF FULL SCALE REFERENCE. IF NOT USED, ENTER 'NON' (NONE).
<b>SUBFRAME DEFINITION</b>			
NUMBER OF SUBFRAMES	1	A-x\SF\N	SPECIFY THE NUMBER OF SUBMULTIPLEXED CHANNELS IN THE FRAME.
SUBFRAME n LOCATION	3	A-x\SF1-n	CHANNEL NUMBER OF THE SUBFRAME. (REPEAT THIS ENTRY AND THE FOLLOWING TWO ENTRIES FOR EACH SUBFRAME AS A SET.)
SUBFRAME n SYNCHRONIZATION	3	A-x\SF2-n	SPECIFY THE SYNCHRONIZATION PATTERN FOR THE SUBFRAME: IRIG 106 - 'STD' OTHER - 'OTH'
SUBFRAME n SYNCHRONIZATION PATTERN	5	A-x\SF3-n	DEFINE THE OTHER (NONSTANDARD) SYNCHRONIZATION PATTERN IN TERMS OF: 0 – ZERO SCALE H – HALF SCALE F – FULL SCALE X – DON'T CARE OTH – OTHER

**TABLE 9-8 (Cont'd). PAM ATTRIBUTES GROUP (A)**

<b>PARAMETER</b>	<b>MAXIMUM FIELD SIZE</b>	<b>CODE NAME</b>	<b>DEFINITION</b>
<b>CHANNEL ASSIGNMENT</b>			
MEASUREMENT NAME	32	A-x\MN1-n	GIVE THE MEASUREMENT NAME.
SUBCOM	1	A-x\MN2-n	IS THIS A SUBCOMMUTATED CHANNEL? 'Y' OR 'N'
SUPERCOM	1	A-x\MN3-n	IS THIS A SUPERCOMMUTATED CHANNEL? IF YES, ENTER THE NUMBER OF POSITIONS IT OCCUPIES – n. IF NO, ENTER - 'N' A SUPERCOMMUTATED SUBCOMMUTATED PARAMETER IS ALLOWABLE AND WILL HAVE ENTRIES IN THIS AND THE PREVIOUS RECORD.
<b>LOCATION</b>			
CHANNEL NUMBER	3	A-x\LCW-n-s	NUMBER OF THE CHANNEL THAT CONTAINS THIS MEASURAND. IF THIS IS A SUBCOMMUTATED CHANNEL, ENTER THE CHANNEL THAT CONTAINS THE SUBCOMMUTATED CHANNEL.
SUBFRAME CHANNEL NUMBER	3	A-x\LCN-n-s-r	CHANNEL NUMBER IN THE SUBFRAME, IF APPROPRIATE.
<b>COMMENTS</b>			
COMMENTS	3200	A-x\COM	PROVIDE THE ADDITIONAL INFORMATION REQUESTED OR ANY OTHER INFORMATION DESIRED.

9.5.8 Data Conversion Attributes (C). The Data Conversion Attributes Group includes a definition of the method by which the raw telemetry data is to be converted to meaningful information. The sensor calibration is contained in the group for each type of sensor that uses a standard calibration curve or for each sensor or parameter that has a unique calibration requirement. The calibration information can be entered in several different formats. Provision is made to permit a test organization to convert data set entries to coefficients of an appropriate curve fit and record the derived coefficients. Figure [9-10](#) shows the structure of the data conversion attributes. Table [9-9](#) contains the detailed information required.



For reference purposes, the following telemetry unit definitions apply:  
PCM – natural binary range as indicated by binary format entry  
PAM – 0 to full scale (100)  
FM (Analog) – lower band edge (–100) to upper band edge (+100).

MEASUREMENT NAME	<b>Data Conversion Attributes Group (C)</b>	CODE NAME	REFERENCE PAGE
		(C-d\DCN)	(9-71)
	<b>*TRANSDUCER INFORMATION</b>		
	TYPE	(C-d\TRD1)	(9-71)
	MODEL NUMBER	(C-d\TRD2)	
	SERIAL NUMBER	(C-d\TRD3)	
	SECURITY CLASSIFICATION	(C-d\TRD4)	
	ORIGINATION DATE	(C-d\TRD5)	
	REVISION NUMBER	(C-d\TRD6)	
	ORIENTATION	(C-d\TRD7)	
	<b>*POINT OF CONTACT</b>		(9-71)
	NAME	(C-d\POC1)	
	AGENCY	(C-d\POC2)	
	ADDRESS	(C-d\POC3)	
	TELEPHONE	(C-d\POC4)	
	<b>*MEASURAND</b>		(9-72)
	DESCRIPTION	(C-d\MN1)	
	MEASUREMENT ALIAS	(C-d\MNA)	
	EXCITATION VOLTAGE	(C-d\MN2)	
	ENGINEERING UNITS	(C-d\MN3)	
	LINK TYPE	(C-d\MN4)	
	<b>*TELEMETRY VALUE DEFINITION</b>		(9-72)
	BINARY FORMAT	(C-d\BFM)	
	FLOATING POINT FORMAT	(C-d\FPF)	
	<b>*INFLIGHT CALIBRATION</b>		(9-72)
	NUMBER OF POINTS	(C-d\MC\N)	
	STIMULUS	(C-d\MC1-n)	
	TELEMETRY VALUE	(C-d\MC2-n)	
	DATA VALUE	(C-d\MC3-n)	
	<b>*AMBIENT VALUE</b>		(9-73)
	NUMBER OF AMBIENT CONDITIONS	(C-d\MA\N)	
	STIMULUS	(C-d\MA1-n)	
	TELEMETRY VALUE	(C-d\MA2-n)	
	DATA VALUE	(C-d\MA3-n)	
	<b>*OTHER INFORMATION</b>		(9-73)
	HIGH MEASUREMENT VALUE	(C-d\MOT1)	
	LOW MEASUREMENT VALUE	(C-d\MOT2)	
	HIGH ALERT LIMIT VALUE	(C-d\MOT3)	
	LOW ALERT LIMIT VALUE	(C-d\MOT4)	
	HIGH WARNING LIMIT VALUE	(C-d\MOT5)	
	LOW WARNING LIMIT VALUE	(C-d\MOT6)	
	SAMPLE RATE	(C-d\SR)	

Continued on next page

Figure 9-10. Data Conversion Attributes Group (C).

	*DATA CONVERSION		(9-74)	
	DATE AND TIME RELEASED	(C-d\CRT)		
	CONVERSION TYPE	(C-d\DCT)		
	*ENGINEERING UNITS CONVERSION		(9-75)	
	*PAIR SETS		(9-75)	
	OR	NUMBER OF SETS	(C-d\PS\N)	
		APPLICATION	(C-d\PS1)	
		ORDER OF FIT	(C-d\PS2)	
		TELEMETRY VALUE	(C-d\PS3-n)	
		ENGINEERING UNITS VALUE	(C-d\PS4-n)	
	*COEFFICIENTS		(9-75)	
	OR	ORDER OF CURVE FIT	(C-d\CO\N)	
		DERIVED FROM PAIR SET	(C-d\CO1)	(9-75)
		COEFFICIENT (0)	(C-d\CO)	
		N-TH COEFFICIENT	(C-d\CO-n)	
	*OTHER		(9-76)	
	OR	DEFINITION OF OTHER DATA CONVERSION	(C-d\OTH)	
	*DERIVED PARAMETER		(9-76)	
	OR	NUMBER OF INPUT MEASURANDS	(C-d\DP\N)	
		MEASURAND #N	(C-d\DP-n)	
		NUMBER OF INPUT CONSTANTS	(C-d\DPC\N)	
		CONSTANT #N	(C-d\DPC-n)	
		ALGORITHM	(C-d\DPA)	(9-76)
	*DISCRETE		(9-76)	
OR	NUMBER OF EVENTS	(C-d\DIC\N)		
	NUMBER OF INDICATORS	(C-d\DI\N)		
	CONVERSION DATA	(C-d\DI\N)		
	PARAMETER EVENT DEFINITION	(C-d\DI\N)		
* PCM TIME		(9-77)		
OR	PCM TIME WORD FORMAT	(C-d\PTM)		
* 1553 TIME		(9-77)		
OR	1553 TIME WORD FORMAT	(C-d\BTM)		
*DIGITAL VOICE		(9-77)		
	ENCODING METHOD	(C-d\VOI\E)		
OR	DESCRIPTION	(C-d\VOI\D)		
*DIGITAL VIDEO		(9-78)		
	ENCODING METHOD	(C-d\VID\E)		
	DESCRIPTION	(C-d\VID\D)		
OR	*COMMENTS			
	COMMENTS	(C-d\COM)	(9-78)	

\*Heading Only - No Data Entry

Figure 9-10 (Cont'd). Data Conversion Attributes Group (C).



**TABLE 9-9. DATA CONVERSION ATTRIBUTES GROUP (C)**

<b>TABLE 9-9. DATA CONVERSION ATTRIBUTES GROUP (C)</b>			
<b>PARAMETER</b>	<b>MAXIMUM FIELD SIZE</b>	<b>CODE NAME</b>	<b>DEFINITION</b>
MEASUREMENT NAME	32	C-d\DCN	GIVE THE MEASUREMENT NAME.
<b>TRANSDUCER INFORMATION</b>			
TYPE	32	C-d\TRD1	TYPE OF SENSOR, IF APPROPRIATE
MODEL NUMBER	32	C-d\TRD2	IF APPROPRIATE
SERIAL NUMBER	32	C-d\TRD3	IF APPLICABLE
SECURITY CLASSIFICATION	2	C-d\TRD4	ENTER THE SECURITY CLASSIFICATION OF THIS MEASURAND. UNCLASSIFIED - 'U' CONFIDENTIAL - 'C' SECRET - 'S' TOP SECRET - 'T' OTHER - 'O' APPEND THE FOLLOWING: IF RECEIVED TELEMETRY SIGNAL (COUNTS) IS CLASSIFIED, ADD 'R'. IF EXPRESSED IN ENGINEERING UNITS, THE MEASURAND VALUE IS CLASSIFIED, ADD 'E'. IF BOTH ARE CLASSIFIED, ADD 'B'.
ORIGINATION DATE	10	C-d\TRD5	DATE OF ORIGINATION OF THIS DATA FILE. DD – DAY                   MM – MONTH YYYY – YEAR           (MM-DD-YYYY)
REVISION NUMBER	4	C-d\TRD6	SPECIFY THE REVISION NUMBER OF THE DATA PROVIDED.
ORIENTATION	32	C-d\TRD7	DESCRIBE THE PHYSICAL ORIENTATION OF THE SENSOR.
POINT OF CONTACT:			POINT OF CONTACT WITH THE ORGANIZATION THAT PROVIDED THE CALIBRATION DATA
NAME	24	C-d\POC1	
AGENCY	48	C-d\POC2	
ADDRESS	48	C-d\POC3	
TELEPHONE	20	C-d\POC4	

**TABLE 9-9 (Cont'd). DATA CONVERSION ATTRIBUTES GROUP (C)**

PARAMETER	MAXIMUM FIELD SIZE	CODE NAME	DEFINITION
<b>MEASURAND</b>			
DESCRIPTION	64	C-d\MN1	DESCRIBE THE PARAMETER BEING MEASURED.
MEASUREMENT ALIAS	32	C-d\MNA	ALTERNATE MEASURAND NAME
EXCITATION VOLTAGE	10	C-d\MN2	SENSOR REFERENCE VOLTAGE, IN VOLTS
ENGINEERING UNITS	16	C-d\MN3	DEFINE THE ENGINEERING UNITS APPLICABLE TO THE OUTPUT DATA.
LINK TYPE	3	C-d\MN4	DEFINE THE SOURCE DATA LINK TYPE: FM (ANALOG) - 'ANA'    PCM - 'PCM' PAM - 'PAM'    OTHER - 'OTH'
<b>TELEMETRY VALUE DEFINITION</b>			
BINARY FORMAT	3	C-d\BFM	FORMAT OF THE BINARY INFORMATION: INTEGER - 'INT' UNSIGNED BINARY - 'UNS' SIGN AND MAGNITUDE BINARY (+=0) - 'SIG' SIGN AND MAGNITUDE BINARY (+=1) - 'SIM' ONE'S COMPLEMENT - 'ONE' TWO'S COMPLEMENT - 'TWO' OFFSET BINARY - 'OFF' FLOATING POINT - 'FPT' BINARY CODED DECIMAL - 'BCD' OTHER - 'OTH,' DEFINE IN COMMENTS.
FLOATING POINT FORMAT	8	C-d\FPF	IF BINARY FORMAT IS 'FPT', SPECIFY WHICH FLOATING POINT FORMAT WILL BE USED.
<b>INFLIGHT CALIBRATION</b>			
NUMBER OF POINTS	1	C-d\MC\N	IS INFLIGHT CALIBRATION REQUIRED? 'N' FOR NO OR A NUMBER BETWEEN 1 AND 5, IF IT IS REQUIRED. A MAXIMUM OF FIVE CALIBRATION POINTS MAY BE INCLUDED.

**TABLE 9-9 (Cont'd). DATA CONVERSION ATTRIBUTES GROUP (C)**

<b>PARAMETER</b>	<b>MAXIMUM FIELD SIZE</b>	<b>CODE NAME</b>	<b>DEFINITION</b>
STIMULUS	32	C-d\MC1-n	PROVIDE THE STIMULUS FOR THIS CALIBRATION POINT.
TELEMETRY VALUE	16	C-d\MC2-n	TELEMETRY UNITS VALUE
DATA VALUE	32	C-d\MC3-n	ENGINEERING UNITS VALUE, SCIENTIFIC NOTATION MAY BE USED.
<b>NOTE:</b> THE ABOVE SET OF THREE ENTRIES MUST BE REPEATED FOR EACH INFLIGHT CALIBRATION POINT.			
<b>AMBIENT VALUE</b>			
NUMBER OF AMBIENT CONDITIONS	1	C-d\MA\N	NUMBER OF STATIC OR SIMULATED CONDITIONS
STIMULUS	32	C-d\MA1-n	DESCRIPTION OF THE STATIC ENVIRONMENT IN WHICH A NONTEST STIMULUS OR SIMULATOR IS THE DATA SOURCE
TELEMETRY VALUE	16	C-d\MA2-n	TELEMETRY UNITS VALUE FOR THE STATIC STIMULUS
DATA VALUE	32	C-d\MA3-n	ENGINEERING UNITS VALUE FOR THE STATIC OR SIMULATED CONDITION. SCIENTIFIC NOTATION MAY BE USED.
<b>OTHER INFORMATION</b>			
HIGH MEASUREMENT VALUE	32	C-d\MOT1	HIGHEST ENGINEERING UNIT VALUE DEFINED BY THE CALIBRATION DATA, SCIENTIFIC NOTATION MAY BE USED.
LOW MEASUREMENT VALUE	32	C-d\MOT2	LOWEST ENGINEERING UNIT VALUE DEFINED IN THE CALIBRATION DATA, SCIENTIFIC NOTATION MAY BE USED.
HIGH ALERT LIMIT VALUE	32	C-d\MOT3	HIGHEST ENGINEERING UNIT VALUE EXPECTED OR SAFE OPERATING VALUE OF THE PARAMETER ("RED"), SCIENTIFIC NOTATION MAY BE USED.

**TABLE 9-9 (Cont'd). DATA CONVERSION ATTRIBUTES GROUP (C)**

PARAMETER	MAXIMUM FIELD SIZE	CODE NAME	DEFINITION
LOW ALERT LIMIT VALUE	32	C-d\MOT4	LOWEST ENGINEERING UNIT VALUE EXPECTED OR SAFE OPERATING VALUE OF THE PARAMETER ("RED"), SCIENTIFIC NOTATION MAY BE USED.
HIGH WARNING LIMIT VALUE	32	C-d\MOT5	HIGHEST ENGINEERING UNIT VALUE EXPECTED OR SAFE OPERATING VALUE OF THE PARAMETER ("YELLOW"), SCIENTIFIC NOTATION MAY BE USED.
LOW WARNING LIMIT VALUE	32	C-d\MOT6	LOWEST ENGINEERING UNIT VALUE EXPECTED OR SAFE OPERATING VALUE OF THE PARAMETER ("YELLOW"), SCIENTIFIC NOTATION MAY BE USED.
SAMPLE RATE	6	C-d\SR	ENTER THE SAMPLE RATE IN TERMS OF SAMPLES/SECOND.
<b>DATA CONVERSION</b>			
DATE AND TIME RELEASED	19	C-d\CRT	DATE AND TIME CALIBRATION WAS RELEASED: DD – DAY           MM – MONTH YYYY – YEAR      HH – HOUR MI – MINUTE      SS – SECOND (MM-DD-YYYY-HH-MI-SS)
CONVERSION TYPE	3	C-d\DCT	DEFINE THE CHARACTERISTICS OF THE DATA CONVERSION: NONE - 'NON' ENGINEERING UNITS: PAIR SETS - 'PRS' COEFFICIENTS - 'COE' DERIVED - 'DER' DISCRETE - 'DIS' PCM TIME - 'PTM' 1553 TIME - 'BTM' DIGITAL VOICE - 'VOI' DIGITAL VIDEO - 'VID' SPECIAL PROCESSING - 'SP' (ENTER IN COMMENTS RECORD.) OTHER - 'OTH'

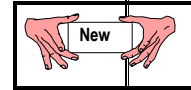

**TABLE 9-9 (Cont'd). DATA CONVERSION ATTRIBUTES GROUP (C)**

PARAMETER	MAXIMUM FIELD SIZE	CODE NAME	DEFINITION
<b>ENGINEERING UNITS CONVERSION</b>			
<b>PAIR SETS</b>			
NUMBER OF SETS	2	C-d\PS\N	SPECIFY THE NUMBER OF PAIR SETS PROVIDED, n.
APPLICATION	1	C-d\PS1	ARE THE PAIR SETS TO BE USED TO DEFINE A POLYNOMIAL CURVE FIT? 'Y' (YES) OR 'N' (NO). IF THE ANSWER IS NO, THEN THE PAIR SETS ARE TO BE USED AS A "TABLE LOOKUP" WITH LINEAR INTERPOLATION BETWEEN THE DEFINED POINTS.
ORDER OF FIT	2	C-d\PS2	SPECIFY THE ORDER OF THE CURVE FIT TO BE PERFORMED, m. AT LEAST 2 PAIR SETS MUST BE PROVIDED, AND A MAXIMUM OF 32 PAIR SETS MAY BE INCLUDED. TWELVE OR MORE PAIR SETS ARE RECOMMENDED FOR A FIFTH ORDER FIT.
TELEMETRY VALUE	16	C-d\PS3-n	TELEMETRY UNITS VALUE
ENGINEERING UNITS VALUE	32	C-d\PS4-n	ENGINEERING UNITS VALUE, SCIENTIFIC NOTATION MAY BE USED.
<b>NOTE:</b> REPEAT THE ABOVE FOR THE n PAIR SETS.			
<b>COEFFICIENTS</b>			
ORDER OF CURVE FIT	2	C-d\CO\N	SPECIFY THE ORDER OF THE POLYNOMIAL CURVE FIT, n.
DERIVED FROM PAIR SET	1	C-d\CO1	WERE THE COEFFICIENTS DERIVED FROM THE PAIR SET CALIBRATION DATA PROVIDED ('Y' OR 'N')? IF YES, PROVIDE A POINT OF CONTACT IN THE COMMENTS RECORD.
COEFFICIENT (0)	32	C-d\CO	VALUE OF THE ZERO ORDER TERM (OFFSET), SCIENTIFIC NOTATION MAY BE USED.

**TABLE 9-9 (Cont'd). DATA CONVERSION ATTRIBUTES GROUP (C)**

PARAMETER	MAXIMUM FIELD SIZE	CODE NAME	DEFINITION
N-TH COEFFICIENT	32	C-d\CO-n	VALUE OF THE COEFFICIENT OF THE N-TH POWER OF X (FIRST ORDER COEFFICIENT IS THE EQUIVALENT OF BIT WEIGHT). SCIENTIFIC NOTATION MAY BE USED.
<b>NOTE:</b> REPEAT UNTIL ALL N+1 COEFFICIENTS ARE DEFINED.			
<b>OTHER</b>			
DEFINITION OF OTHER DATA CONVERSION	1000	C-d\OTH	DEFINE OTHER DATA CONVERSION TECHNIQUE OR SPECIAL PROCESSING REQUIREMENT.
<b>DERIVED PARAMETER</b>			
NUMBER OF INPUT MEASURANDS	2	C-d\DP\N	SPECIFY THE NUMBER OF INPUT MEASURANDS USED TO DERIVE THIS PARAMETER.
MEASURAND #N	32	C-d\DP-n	SPECIFY THE NAME OF THE N-TH INPUT MEASURAND.
<b>NOTE:</b> CONTINUE UNTIL ALL N MEASURANDS ARE DEFINED.			
NUMBER OF INPUT CONSTANTS	2	C-d\DPC\N	SPECIFY THE NUMBER OF INPUT CONSTANTS USED TO DERIVE THIS PARAMETER.
CONSTANT #N	32	C-d\DPC-n	SPECIFY THE VALUE FOR THE N-TH CONSTANT. SCIENTIFIC NOTATION MAY BE USED.
<b>NOTE:</b> CONTINUE UNTIL ALL N CONSTANTS ARE DEFINED.			
ALGORITHM	240	C-d\DPA	DEFINE THE ALGORITHM TO BE USED IN DERIVING THE PARAMETER.
<b>DISCRETE</b>			
NUMBER OF EVENTS	2	C-d\DIC\N	HOW MANY EVENTS ARE ASSOCIATED WITH THIS DISCRETE FIELD, n?

**TABLE 9-9 (Cont'd). DATA CONVERSION ATTRIBUTES GROUP (C)**

<b>PARAMETER</b>	<b>MAXIMUM FIELD SIZE</b>	<b>CODE NAME</b>	<b>DEFINITION</b>
NUMBER OF INDICATORS	2	C-d\DICI\N	NUMBER OF INDICATORS: FOR A PCM SYSTEM, PROVIDE THE NUMBER OF BITS USED FOR THIS DISCRETE SET. FOR A PAM OR ANALOG CHANNEL, PROVIDE THE NUMBER OF LEVELS USED TO DEFINE THIS DISCRETE SET.
CONVERSION DATA	16	C-d\DICC-n	TELEMETRY VALUE, COUNTS FOR PCM, PERCENT OF FULL SCALE FOR PAM OR ANALOG.
PARAMETER EVENT DEFINITION	240	C-d\DICP-n	DEFINE THE EVENT FOR THE BIT OR BIT FIELD IN A WORD THAT CORRESPONDS TO A DISCRETE EVENT OR THE PERCENT FULL SCALE VALUE SUCH AS SWITCH ON OR OFF.
<b>NOTE:</b> CONTINUE TO DEFINE THE EVENTS FOR EACH BIT PATTERN OR VALUE OF THE DISCRETE MEASURAND.			
<b>PCM TIME</b>			
PCM TIME WORD FORMAT	1	C-d\PTM	SPECIFY THE PCM TIME WORD FORMAT USED, AS DEFINED IN PARAGRAPH 4.7. HIGH ORDER TIME - 'H' LOW ORDER TIME - 'L' MICROSECOND TIME - 'M'
<b>1553 TIME</b>			
1553 TIME WORD FORMAT	1	C-d\BTM	SPECIFY THE 1553 TIME WORD FORMAT USED, AS DEFINED IN PARAGRAPHS 4.7 AND 8.5. HIGH ORDER TIME - 'H' LOW ORDER TIME - 'L' MICROSECOND TIME - 'M' RESPONSE TIME - 'R'
<b>DIGITAL VOICE</b>			
ENCODING METHOD	4	C-d\VOI\E	SPECIFY THE VOICE ENCODING METHOD USED: CVSD - 'CVSD' OTHER - 'OTHR'

**TABLE 9-9 (Cont'd). DATA CONVERSION ATTRIBUTES GROUP (C)**

<b>PARAMETER</b>	<b>MAXIMUM FIELD SIZE</b>	<b>CODE NAME</b>	<b>DEFINITION</b>
DESCRIPTION	640	C-d\VOID	SPECIFY THE DECODING ALGORITHM TO BE USED.
<b>DIGITAL VIDEO</b>			
ENCODING METHOD	64	C-d\VID\E	SPECIFY THE VIDEO ENCODING METHOD USED.
DESCRIPTION	640	C-d\VID\D	SPECIFY THE DECODING ALGORITHM TO BE USED.
<b>COMMENTS</b>			
COMMENTS	3200	C-d\COM	PROVIDE THE ADDITIONAL INFORMATION REQUESTED OR ANY OTHER INFORMATION DESIRED.



9.5.9 Airborne Hardware Attributes (H). The Airborne Hardware Attributes Group defines the specific configuration of airborne instrumentation hardware in use on the item under test. This group allows the same TMATS file to describe the airborne hardware as well as the telemetry attributes.

Specific information on the structure and definition of airborne hardware attributes is not included in this standard. There are far too many hardware systems to try to define them all in one group. The main purpose of identifying this group is to reserve the 'H' designation for those instrumentation organizations which choose to use the TMATS standard in this way.

The only H group attributes defined in this standard are the following:

Test Item (code name H-x\TA) specifies the item under test and ties the H group to the G group.

Airborne System Type (code name H-x\ST-n) will distinguish which airborne systems are being described in the current file and will determine how the rest of the attributes in the H group are interpreted.



For anyone wishing to define an H group, it is strongly recommended that the conventions laid out in this standard be followed. The resultant document should maintain the look and feel of this standard for consistency.

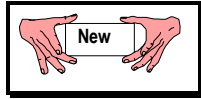

9.5.10 Vendor Specific Attributes (V). The Vendor Specific Attributes Group provides information that is specific to a vendor. This group allows the TMATS file to include information about a particular vendor's equipment in use during a test. Detailed information about specific vendors' equipment is not included in this standard.

The only V-group attributes defined in this standard are the following:

- Data Source ID (code name V-x\ID) specifies the Data Source ID consistent with the General Information Group and ties the V-group to the G group.
- Vendor Name (code name V-x\VN) is a three character acronym that identifies the specific vendor and determines how the rest of the attributes in the V group are interpreted.

All other code names for vendor specific attributes will have the form:

V-x\acr\attribute-string

where 'acr' is the three character acronym identifying a specific vendor and 'attribute-string' is any attribute that applies to this vendor.



For anyone wishing to define a V group, it is strongly recommended that the conventions laid out in this standard be followed. The resultant document should maintain the look and feel of this standard for consistency.

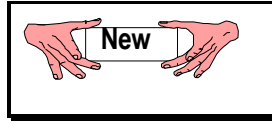

## CHAPTER 10

### SOLID STATE ON-BOARD RECORDER STANDARD

#### 10.1 General

A large number of unique and proprietary data structures have been developed lately for specific data recording applications that require unique decoding software programs. Writing unique decoding software, checking the software for accuracy, and decoding the data tapes is extremely time consuming and costly. In addition, the test ranges have seen the implementation of non-tape-based, high data-rate recorders in the late 1990s — the most predominate being solid-state memory devices. As high-rate digital recorders were fielded, and with solid state on the horizon, the Telemetry Group (TG) formed an ad-hoc committee to research and write a computer compatible, digital data acquisition standard.

It was determined that a solid-state digital data acquisition and on-board recorder standard (see Figure 10-1) would support a broad range of requirements, including the following:

- a. Data download and interface
- b. One or more multiplexed data streams
- c. One or more single data streams
- d. Read-after-write and read-while-write options
- e. Data format definitions
- f. Recorder control
- g. Solid-state media declassification

Specifically, this digital data acquisition standard shall be compatible with the multiplexing of both synchronous and asynchronous digital inputs such as pulse code modulation (PCM) and MIL-STD-1553 data bus, time, analog, video, ARINC 429, discrete, and RS-232/422 communication data. This solid-state recorder standard will allow the use of a common set of playback/data reduction software to take advantage of emerging random access recording media.

The purpose of this chapter is to establish a common interface standard for the implementation of solid-state digital data acquisition and on-board recording systems by the organizations participating in the Range Commanders Council (RCC). This standard does not specify hardware architecture, e.g., the coupling of data acquisition, multiplexing, and media storage.

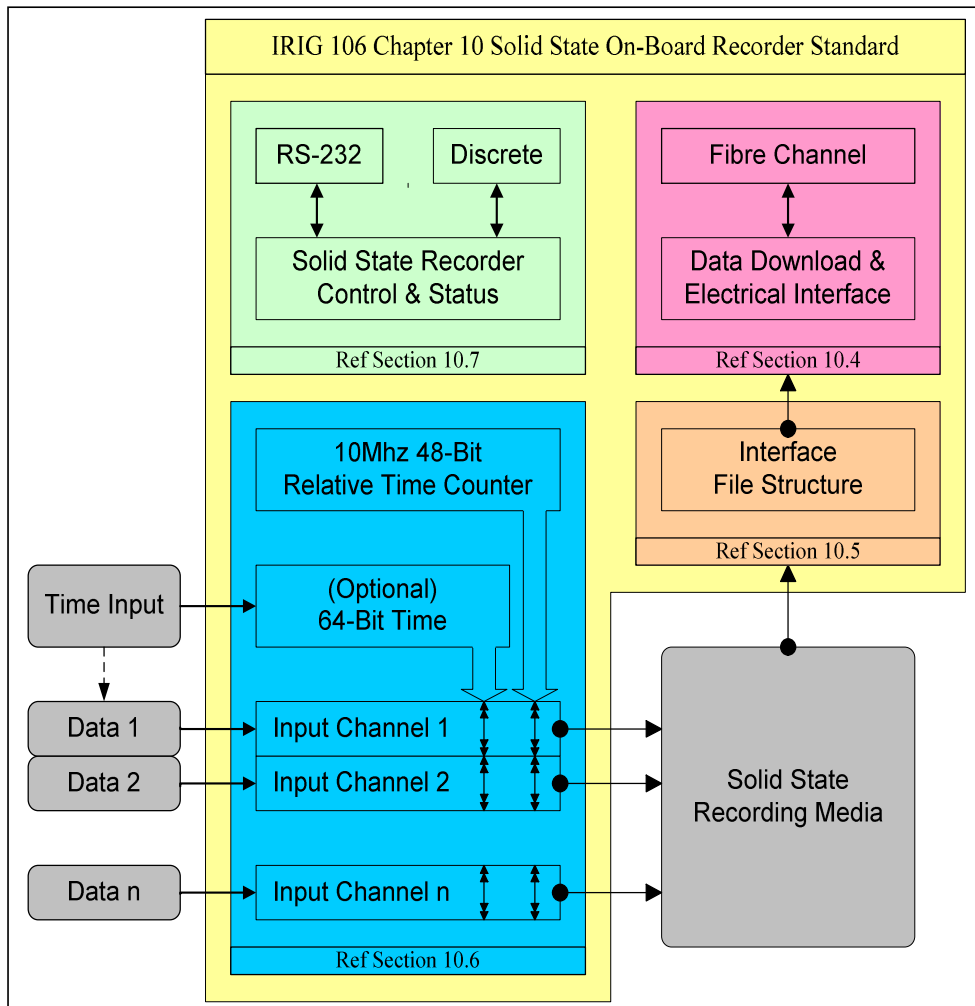

Figure 10-1. Functional layout of standard.

Four interface levels are provided in this standard:

1. Data download and electrical interface, which is the physical interface for data access (defined in section [10.4](#)).
2. Interface file structure, which defines the data access structure (defined in section [10.5](#)).
3. Data format definition, which defines data types and packetization requirements (defined in section [10.6](#)).
4. Solid-state recorder control and status, which defines command and control mnemonics, status, and their interfaces (defined in section [10.7](#)).

## 10.2 Definitions

**Bad Block**: Block that has been determined to be unreliable for storing user data.

**Bad Block Table**: Table of bad block entries for a memory board. The data stored in the entry identifies the chip and block number of the bad block. The table entry also contains a flag field. The flag field is used to determine the circumstance in which the bad block was detected. It also provides a flag indicating whether the corresponding bad block has previously been “secure erased.”

**Block**: Storage unit within the flash device. A block is the smallest unit of memory that can be erased.

**Byte**: A contiguous set of 8 bits that are acted on as a unit.

**Channel ID**: All channels in a system must have a unique value (data channels and playback channels).

**Channel Specific Data Words**: A set of required words for a data type channel that has data specific information.

**Checksum**: Arithmetic sum of data bytes or words.

**Erasing Flash**: Performing an erase function on a flash device. Erasing a flash device sets all bits to a known logic state.

**EVPD**: Enable vital product data.

**Intra-Packet Data Header**: Contains time and status information for the tagging of data inside a packet.

**Long Word**: A contiguous set of 32 bits that are acted on as a unit.

**lsb**: The least significant bit of a series of bits.

**LSB**: The least significant byte of a series of bytes.

LSW: The least significant word of a series of words.

LSLW: The least significant long word of a series of long words.

Magic Number: An identifier for the directory block. This is a value chosen to support discovery of lost directory entries and directory reconstruction after a fault.

Memory Board: Printed circuit board containing flash memory devices used to store user data.

msb: The most significant bit of a series of bits.

MSB: The most significant byte of a series of bytes.

MSW: The most significant word of a series of words.

MSLW: The most significant long word of a series of long words.

Non-volatile: Memory media that retains data when power is removed.

Recorder: The entity that includes the input and control interfaces, RMM, and functionality required to properly record data.

Recording Session: Time interval from first data packet generated to end of the recording.

Relative Time Counter: A free-running 10 MHz binary counter represented by 48-bits common to all data channels. The counter shall be derived from an internal crystal oscillator and shall remain free running during each recording session. The applicable data bit to which the 48-bit value applies will be defined in each data type section.

Removable Memory Module (RMM): That element of the data recorder that contains the stored data.

Packet: Encapsulates a block of observational and ancillary application data that is to be recorded.

Packet Header: Identifies the source and characteristics of the data packet and encapsulation environment.

Packet Secondary Header: Contains packet header time.

Page: Storage unit within the flash device. A page is the smallest storage unit that can be written.

Quad Word: A contiguous set of 64 bits that are acted on as a unit.

Word: A contiguous set of 16 bits that are acted on as a unit.

### 10.3 Operational Requirements

This section of the standard specifies the basic operation and required interfaces for the Solid-State Data Storage and Download.

10.3.1 Required Configuration. Every recorder, as a minimum, shall provide the following functionality:

- a. Download port
- b. Control port
- c. External power port

The required download port interface shall be Fibre Channel. This combination will allow data extraction and transfer from any solid-state recorder to any RCC compliant, intermediate storage unit.

10.3.2 Exclusions to this Standard. The physical size, configuration, and form factor for the recorder and/or the RMM are not controlled by this standard. Due to the variation in capacity/rate/cost requirements of the users, this standard does not specify the technology to be used in the RMM or the recorder.

10.3.3 Internal System Management. Any processing performed on the stored data by the recorder (e.g. for the purposes of internal system management, error detection and correction (EDAC), physical frame formatting, etc.) shall be removed from the stored data when the stored data is downloaded or transferred from storage media.

10.3.4 Data Download. The data acquisition recorder may have a removable memory capability or the whole recorder can be removed from the acquisition platform and taken to a ground station for data download. Reference paragraph [10.4.1](#) for electrical interface requirement.

10.3.5 Data Download File Extension. Upon data download to a host computing platform, all IRIG 106 Chapter 10-compliant recordings shall use the file extension, \*.ch10. The use of this standard extension will indicate that any file on a ground computing or storage platform is in compliance with section 10.6 of this standard.



**IMPORTANT:** Upon data download to a host computing platform, all IRIG 106 Chapter 10-compliant recordings shall use the file extension, \*.ch10.

## 10.4 Data Download and Electrical Interface

In accordance with (IAW) paragraph 10.3.1, the required download port interface shall be Fibre Channel (FC). Physical, signaling, and command protocols contained in paragraphs 10.4.1 and 10.4.2 were adapted from the North Atlantic Treaty Organization (NATO) Military Agency for Standardization (MAS) Standardization Agreement (STANAG) NATO Advanced Data Storage Interface (NADSI) number 4575 hereinafter referred to in this document as STANAG 4575.

10.4.1 Physical and Signaling Protocols. The interface shall comply with FC-PI (physical interfaces) and FC-FS (framing and signaling) with configuration options as specified below.

- a. Physical media. Either Fibre Channel copper or optical fiber interface can be utilized.
- b. Signaling rate. The transmission signaling rate shall be 1.0625 giga-baud.

10.4.2 Command Protocol. The interface shall conform to the requirements of the Fibre Channel - Private Loop SCSI Direct Attach (FC-PLDA)<sup>27</sup> interoperability. Table 17 of FC-PLDA specifies a control protocol using a subset of commands, features, and parameters defined for the Small Computer System Interface (SCSI-3). Table 17 also defines the command feature and parameter usage categories of "Required," "Allowed," "Invokable," and "Prohibited" between the SCSI Initiator and Target. These definitions assume that the Target is a magnetic disk drive or equivalent device.

The control protocol must support a number of data storage media types. Only the minimum set of SCSI commands needed to download mission data from a memory cartridge are defined as "required." FC-PLDA SCSI commands, features, and parameters not defined as "required" for this standard are redefined as "allowed" and may be implemented as appropriate. Table [10-1](#) provides the four "required" SCSI commands and their features and parameter usage definitions.

---

<sup>27</sup> Document published as ANSI INCITS TR19-1998.



**TABLE 10-1.  
“REQUIRED” SCSI COMMANDS, FEATURES, AND PARAMETERS<sup>28</sup>**

COMMANDS/FEATURES	INITIATOR	TARGET	NOTES
<b>INQUIRY</b>	I	R	
Standard INQUIRY data (bytes 0-35)	I	R	
EVPD = 1	I	R	
Vital Product Data page codes:			
hex'00' (supported vital product pages)	I	R	
hex'80' (unit serial number page)	I	R	
hex'81' (implemented operations definition pg.)	I	A	
hex'82' (ASCII implemented operations def. pg.)	I	A	
hex'83' (device identification page)	I	R	
<b>READ (10)</b>	I	R	
DPO = 0	I	A	1
DPO = 1	I	A	1
FUA = 0	I	A	2
FUA = 1	I	A	2
RelAdr = 0	R	R	
RelAdr = 1	P	P	3
<b>READ CAPACITY</b>	I	R	3
RelAdr = 0	R	R	
RelAdr = 1	P	P	
PMI = 0	I	R	
PMI = 1	I	A	
<b>TEST UNIT READY</b>	I	R	

**Notes:**

1. The Disable Page Out (DPO) bit is associated with a device data caching policy.
2. The Force Unit Access (FUA) bit is associated with whether the device may or may not return the requested Read data from its local cache.
3. Relative Offset is prohibited since this requires the use of linking that is prohibited.

P = Prohibited: The feature shall not be used between FC-PLDA compliant devices.

R = Required: The feature or parameter value shall be implemented by FC-PLDA compliant devices.

A = Allowed: The feature or parameter may be used between FC-PLDA compliant devices. The initiator determines if an “allowed” feature/parameter is supported via a required discovery process or a minimal response by the recipient.

I = Invokable: The feature or parameter may be used between FC-PLDA compliant devices. The recipient shall support “invokable” features or provide a response that it is not implemented as defined by the appropriate standard.

<sup>28</sup> Adapted from STANAG 4575, Table B-1.

## 10.5 Interface File Structure Definition

This interface file structure definition is adopted from STANAG 4575.<sup>29</sup> This file structure was selected to facilitate host computing platform independence and commonality. By incorporating an independent file structure backward and forward compatibility is ensured for the life of the standard.



This file structure definition does not define how data is physically stored on the recorder media, but provides a standardized method for access of the stored data at the interface. Data can be physically organized any way appropriate to the media, including multiple directories, as long as the file structure IAW section [10.5](#) is maintained or seen at the interface (section [10.4](#)).

10.5.1 Data Organization. A data recording can contain a single file, which is composed of one or more types of packetized data, or multiple files, in which one or more types of data are recorded simultaneously in separate files. For a recording file to be in compliance with this standard, it must contain, as a minimum, the following:

- a. Computer Generated Packet, Setup Record Format 1, in accordance with (IAW) paragraph [10.6.7.2.2](#) as the first packet in the recording.
- b. Time Data Packet(s) IAW paragraph [10.6.3](#) as the first dynamic packet after the Computer Generated Packet Set Record.
- c. One or more data format packets IAW section [10.6](#).

Multiple recordings may reside on the media, and each recording may contain one or more compliant files.

10.5.1.1 Data Hierarchy: The structures used to define the data stored according to this standard shall have the following relationships (highest to lowest), as depicted in Figure [10-2](#).

10.5.1.1.1 Directory: One or more directory blocks of data comprising a list of all Data Files located under the guidance of this Standard. Also contains supporting data that may be of interest to those manipulating the Data Files. The list of files is made up from "File Entries." The Directory shall always start at logical address zero of each directory block.

10.5.1.1.2 Directory Block: A block containing directory entries and other metadata.

---

<sup>29</sup> Annex B Protocol Interface Definitions, section 3, File Structure Definition.

10.5.1.1.3 Directory Block File Entry: A fixed-length data structure used to describe files. It contains the name, the starting address, the number of blocks of data assigned to the Data File, the total number of bytes contained in the file, and the file's creation date and time. It also contains a reserved field for future growth and a vendor-unique field.

10.5.1.1.4 Data Files: Data files are comprised of user data, presented at the interface in monotonically increasing contiguous logical addresses per file. Thus, if a file starts at logical address X, the next location containing file data must be at the next logical address, X+1, and the next location after that must be at the next logical address, X+2, etc.

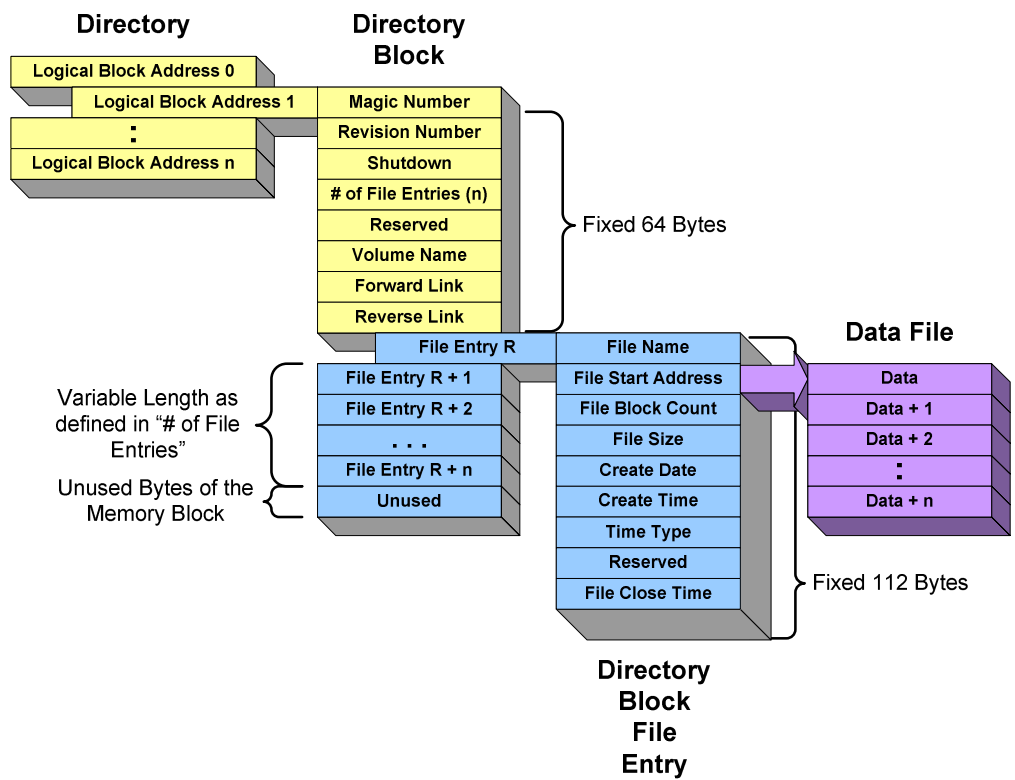

Figure 10-2. Directory Block Structure.

10.5.2 **Directory Definition:** Name and location information for all files is recorded in a Directory (see Figure 10-2). The Directory is composed of one or more directory blocks as shown in Figure 10-3. At least one Directory Block is required and it must be located at SCSI logical block address 1. (Logical block address 0 is defined as a vendor unique area; its contents are not described or controlled by this standard.)

10.5.2.1 **Directory Fixed Fields:** The fixed fields within a Directory Block are used to name the volume of data, identify the number of entries, and to provide pointers to other addresses that contain additional directory blocks. The forward and backward link to the next address for the next Directory Block (if any) as well as back to the preceding Directory Block (if any). This allows for directory expansion beyond a single block and does not limit the placement of directory information.

10.5.2.2 **Block Size:** The media types used to implement this standard have varying block lengths. Some will have blocks as small as 512 bytes; others may have blocks as large as 64K bytes or larger. The block size used by a given media can be determined via the SCSI Read Capacity Command and is not defined here.

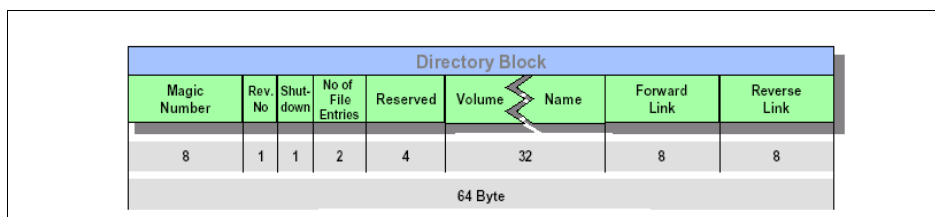

Figure 10-3. Directory Block (as depicted in STANAG 4575).

10.5.2.3 **Directory to Data File Link:** Each Data File on the media has a directory entry within a Directory Block that describes the file, as shown in Table 10-2. The directory entry for a data file contains a link to the starting location of the data contained in each file and the total number of blocks assigned for the storage of data, as shown in Table 10-3. This standard does not define the meaning of the data recorded within these Data File blocks.

<b>TABLE 10-2. DIRECTORY BLOCK FORMAT – PRIMARY BLOCK</b>			
<b>FIELD NAME</b>	<b>BYTES</b>	<b>DESCRIPTION</b>	<b>DATA TYPE</b>
Magic Number	8	An identifier for a directory block. The value is ASCII “FORTYtwo” (Hex – 0x464F52545974776F)	ASCII
Revision Number	1	Revision number of the standard compiled by the recording system. Example first version 00000001.	Unsigned Binary
Shutdown	1	Flag, if cleared to a 00h indicates that the volume was not properly dismounted, if seen on power-up is an indication that the directory chain may be faulty. If set = 0xFF, then file system properly shutdown. This field is only valid in the first directory block; other directory blocks set to 0xFF.	Unsigned Binary
Number of File Entries	2	Defines the number of file entries that follow in this block.	Unsigned Binary
Reserved	4	Fill with 0xFF	Unsigned Binary
VolName	32	Volume name. Fill with all 0x00 for no name.	ASCII
Forward Link	8	Block address of the next block containing directory information. Set equal to address of this block if this is the end of the chain.	Unsigned Binary
Reverse Link	8	Block address of the directory block pointing to this block. Set equal to the address of this block if this is the start of the chain.	Unsigned Binary
(n File Entries)	112 *n	One entry for each file. Total number of directory entries for this directory block as defined by field “Number of Directory Entries”.	See Table 10-3
Padding	Varies with n and Block Size	Pad to block boundary. Default value is 0xFF	Unsigned Binary
<b>Note:</b> 64 bytes in fixed fields.			

<b>TABLE 10-3. DIRECTORY ENTRY FORMAT</b>			
<b>FIELD NAME</b>	<b>BYTES</b>	<b>DESCRIPTION</b>	<b>DATA TYPE</b>
Name	56	File name, see character set for restrictions. Fill with FFh for unused directory entries.	ASCII
FileStartAdd	8	Zero based address of the first block reserved for data associated with this file. Fill with FFh for unused directory entries.	Unsigned Binary
FileBlkCnt	8	One-based number that is the count of consecutive address blocks reserved for data for this file including the block pointed to by the FileStartAdd field. Fill with 00h for unused directory entries.	Unsigned Binary
FileSize	8	The actual number of bytes contained in this file. This file size will be equal to or less than the FileBlkCnt multiplied by the blocksize.	Unsigned Binary
File Create Date	8	DDMMYYYY ASCII character values, with no embedded spaces or other formatting characters, representing the numeric date on which the file was created (e.g. ASCII codes for the decimal digits 02092000 → 30h 32h 30h 39h 32h 30h 30h 30h represents 2 September 2000). Data for this is optional and shall be filled with 30h if this value is not available.	ASCII
File Create Time	8	HHMMSSss character values, with no embedded spaces or other formatting characters, representing the numeric time at which the file was created. HH is the number of the 24 hour based hour, MM is the number of minutes after the hour, SS is the number of seconds after the minute, and ss is the hundredths of seconds after the second.  Data for this is optional and shall be filled with 30h if this value is not available. Fill with 20h if this entire field is not available. Fill the portions of the field with 30h if a portion of the field, e.g., “ss” is not available.	ASCII
Time Type	1	A numeric code that qualifies the time and date values recorded in the “Create Date” and “Create Time” and “Close Time” fields. 00h = Coordinated Universal Time (Zulu) 01h = Local Time 02h – FF = TBD	Unsigned Binary
Reserved	7	Bytes in this region are reserved for future growth. Fill with 00h.	Unsigned Binary

TABLE 10-3 (Cont'd). DIRECTORY ENTRY FORMAT			
FIELD NAME	BYTES	DESCRIPTION	DATA TYPE
File Close Time	8	HHMMSSss character values, with no embedded spaces or other formatting characters, representing the numeric time at which the file was closed. HH is the number of the 24 hour based hour, MM is the number of minutes after the hour, SS is the number of seconds after the minute, and ss is the hundredths of seconds after the second.  Data for this is optional and shall be filled with 30h if this value is not available. Fill with 20h if this entire field is not available. Fill the portions of the field with 30h if a portion of the field, e.g., "ss" is not available.	ASCII
<b>Note:</b> 112 bytes in fixed fields.			

10.5.2.4 File Entry Name. Each file entry in a directory shall have a unique name (see character set paragraphs [10.5.3.2.1](#) and [10.5.3.2.2](#)).

10.5.2.5 Entry Singularity. Multiple Directory entries are not permitted to refer to the same data, either partially or completely.

10.5.2.6 Directory Entries and Fields. Directory block fields and entries shall be logically contiguous.

### 10.5.3 Data Definitions

10.5.3.1 Byte Order: The structures described in this Standard are defined to have the following bit and byte orientation. The least significant byte shall be transmitted first, the least significant bit of each byte shall be transmitted first, and data is read from the lowest logical address first. Fields defined with data type of ASCII are stored in the order shown in the field description, starting with the lowest logical address. Directory blocks are stored in the order shown in the tables, starting with the lowest logical address.

Assuming a 32-bit entry, composed of four 8-bit bytes, where the first and least significant byte is byte [0] and the last and most significant is byte [3], then the correspondence of bits to bytes, where bit [00] is the least significant bit, is as follows in Table [10-4](#).

TABLE 10-4. CORRESPONDENCE OF BITS TO BYTES								
Bit:	7	6	5	4	3	2	1	0
Byte [3]	31	30	29	28	27	26	25	24
Byte [2]	23	22	21	20	19	18	17	16
Byte [1]	15	14	13	12	11	10	9	8
Byte [0]	7	6	5	4	3	2	1	0

10.5.3.2 Naming Restrictions. The following rules shall be applied when forming names in order to assure the highest degree of interchange among other operating systems.

10.5.3.2.1 Characters. Characters from the first 127 common ASCII characters (00h through 7Eh) may be used in names except for specific prohibited characters.

Any ASCII character code value smaller than 20h is prohibited, except where the <00h> is used to terminate the name. The other prohibited characters with their hexadecimal representation are defined in Table [10-5](#).

TABLE 10-5. PROHIBITED CHARACTERS HEXIDECIMAL REPRESENTATION			
Forbidden Characters in Names	Hexadecimal Value	Forbidden Characters in Names	Hexadecimal Value
”	22h	=	3Dh
‘	27h	>	3Eh
*	2Ah	?	3Fh
/	2Fh	\	5Ch
:	3Ah	]	5Dh
;	3Bh	[	5Eh
<	3Ch		7Ch



10.5.3.2.2 Names. Names used for this interface will observe the following rules:

- a. Filenames shall not be case sensitive.
- b. Leading and trailing spaces are not permitted.
- c. Leading periods are not permitted.
- d. Names shall be left-justified in the field and are terminated with a null<00h>. The maximum length of the name is the length of the field minus one.

## 10.6 Data Format Definition

10.6.1 Common Packet Elements. Data shall have three required parts, a Packet Header, a Packet Body, a Packet Trailer, and an optional part if enabled, a Packet Secondary Header. See Figure 10-4 for a diagram of the generic packet format. This figure does not depict the bit lengths of each field. Depending on the data type, 8-bit, 16-bit and 32-bit word sizes are used. The size of a single packet may be a maximum of 524,288 bytes, with one exception. The first packet in the file must be a Computer Generated Data Packet, Format 1 Setup Records, may be a maximum of 134,217,728 bytes.

With the exception of Computer Generated Packets and Time Data Packets, all other packets shall be generated within 100 milliseconds whenever data is available. This requirement ensures that a packet shall contain less than 100 milliseconds worth of data, and that a packet containing any data must be generated within 100 milliseconds from the time the first data was placed in the packet. This strategy will assure packet granularity but save bandwidth by not forcing or marking empty/idle packets.

A packet has the basic structure shown in Figure 10-4. Note that the width of the structure is not related to any number of bits. This figure merely represents the relative packet elements and their placement within the packet.

<b>PACKET SYNC PATTERN</b>	<b>Packet Header</b>
<b>CHANNEL ID</b>	
<b>PACKET LENGTH</b>	
<b>DATA LENGTH</b>	
<b>HEADER VERSION</b>	
<b>SEQUENCE NUMBER</b>	
<b>PACKET FLAGS</b>	
<b>DATA TYPE</b>	
<b>RELATIVE TIME COUNTER</b>	
<b>HEADER CHECKSUM</b>	
<b>TIME</b>	<b>Packet Secondary Header (Optional)</b>
<b>RESERVED</b>	
<b>SECONDARY HEADER CHECKSUM</b>	
<b>CHANNEL SPECIFIC DATA</b>	<b>Packet Body</b>
<b>INTRA-PACKET TIME STAMP 1</b>	
<b>INTRA-PACKET DATA HEADER 1</b>	
<b>DATA 1</b>	
<b>⋮</b>	
<b>INTRA-PACKET TIME STAMP n</b>	
<b>INTRA-PACKET DATA HEADER n</b>	
<b>DATA n</b>	
<b>DATA CHECKSUM</b>	<b>Packet Trailer</b>

Figure 10-4. General Packet Format.

To further clarify the packet layout, Figure 10-5 shows the generic packet in a 32-bit, little-endian format, and assumes 16-bit data words and data checksum.

<b>msb</b> <b>31</b>	<b>16 15</b>	<b>lsb</b> <b>0</b>	
<b>CHANNEL ID</b>		<b>PACKET SYNC PATTERN</b>	
<b>PACKET LENGTH</b>			
<b>DATA LENGTH</b>			
<b>DATA TYPE</b>	<b>PACKET FLAGS</b>	<b>SEQUENCE NUMBER</b>	<b>HEADER VERSION</b>
<b>RELATIVE TIME COUNTER</b>			
<b>HEADER CHECKSUM</b>		<b>RELATIVE TIME COUNTER</b>	
<b>TIME (LSLW)</b>			
<b>TIME (MSLW)</b>			
<b>SECONDARY HEADER CHECKSUM</b>		<b>RESERVED</b>	
<b>CHANNEL SPECIFIC DATA</b>			
<b>INTRA-PACKET TIME STAMP 1</b>			
<b>INTRA-PACKET TIME STAMP 1</b>			
<b>INTRA-PACKET DATA HEADER 1</b>			
<b>DATA 1 WORD 2</b>		<b>DATA 1 WORD 1</b>	
<b>DATA 1 WORD n</b>		:	
<b>INTRA-PACKET TIME STAMP 2</b>			
<b>INTRA-PACKET TIME STAMP 2</b>			
<b>INTRA-PACKET DATA HEADER 2</b>			
<b>DATA 2 WORD 2</b>		<b>DATA 2 WORD 1</b>	
<b>DATA 2 WORD n</b>		:	
:			
<b>INTRA-PACKET TIME STAMP N</b>			
<b>INTRA-PACKET TIME STAMP N</b>			
<b>INTRA-PACKET DATA HEADER N</b>			
<b>DATA N WORD 2</b>		<b>DATA N WORD 1</b>	
<b>DATA N WORD n</b>		:	
<b>[FILLER]</b>			
<b>DATA CHECKSUM</b>			

Figure 10-5. A 32-Bit Packet Format Layout.

Depending on the data type, the size of the Data Checksum can be 16-bits, 32-bits, 8-bits, or left out entirely. For a 32-bit Data Checksum, the packet trailer would be as shown in Figure 10-6:

<b>msb</b> 7	<b>lsb</b> 0	
[ FILLER ]		Packet Trailer
DATA CHECKSUM (LSB)		
----- DATA CHECKSUM		
----- DATA CHECKSUM		
----- DATA CHECKSUM (MSB)		

Figure 10-6. Packet trailer for 32-bit Data Checksum.

For an 8-bit Data Checksum, the packet trailer would be as shown in Figure 10-7:

<b>msb</b> 7	<b>lsb</b> 0	
[ FILLER ]		Packet Trailer
DATA CHECKSUM (LSB)		

Figure 10-7. Packet trailer for 8-bit Data Checksum.

10.6.1.1 Packet Header. The length of the Packet Header is fixed at 24 bytes (192-bits). The Packet Header is mandatory and shall consist of the ten fields, positioned contiguously in the following sequence:

10.6.1.1.1 Packet Sync Pattern: This field (2 bytes) contains a static sync value for every packet. The Packet Sync Pattern value shall be 0xEB25.

10.6.1.1.2 Channel ID. This field (2 bytes) contains a value representing the Packet Channel ID. All channels in a system must have a unique value. Channel value 0x0000 is reserved and is used to insert computer-generated messages into the composite data stream. Channel values 0x0001 thru 0xFFFF are available.

10.6.1.1.3 Packet Length. This field (4 bytes) contains a value representing the length of the entire packet. The value shall be in bytes and is always a multiple of four (bits 1 and 0 shall always be zero). This Packet Length includes the Packet Header, Packet Secondary Header (if enabled), Channel Specific Data, Intra-Packet Data Headers, Data, Filler, and Data Checksum.

10.6.1.1.4 Data Length. This field (4 bytes) contains a value representing the valid data length within the packet. This value shall be represented in bytes. Valid data length includes Channel Specific Data and Intra-Packet Data Headers, and Data, but does not include Filler and Data Checksum.

10.6.1.1.5 Header Version. This field (1 byte) contains a value representing the version of the IRIG-106 standard. The value shall be represented by the following bit patterns:

0x00 = Reserved.

0x01 = Initial Release Header Version.

0x02 thru 0xFF = Reserved for future releases.

10.6.1.1.6 Sequence Number. This field (1 byte) contains a value representing the Packet Sequence Number. This is simply a counter that marks in increments from 0x00 to 0xFF for every packet transferred from a particular channel.



Sequence number counter will repeat if more than 256 packets are transferred in a given recording per channel.

10.6.1.1.7 Packet Flags. This field (1 byte) contains bits representing information on the content and format of the packet(s) as follows:

Bit 7: Indicates the presence or absence of the Packet Secondary Header.

0 = Packet Secondary Header is not present.

1 = Packet Secondary Header is present.

Bit 6: Indicates the Intra-Packet Time Stamp Type.

0 = Packet Header 48-bit Relative Time Counter.

1 = Same as Packet Secondary Header Time (bit 7 must = 1).

Bit 5: Indicates the Relative Time Counter Sync Error.

0 = No Relative Time Counter Sync Error.

1 = Relative Time Counter Sync Error has occurred.

Bit 4: Indicates the Data Overflow Error.

0 = No data overflow.

1 = Data overflow has occurred.

Bits 3-2: Indicates the Packet Secondary Header Time Format.

00 = IRIG 106 Chapter 4 binary weighted 48-bit time format. The two LSBs of the 64-bit Packet Secondary Header Time and Intra-Packet Data Header time shall be zero filled.  
01 = Reserved.  
10 = Reserved.  
11 = Reserved.

**Bits 1-0:** Indicates Data Checksum existence.

00 = No Data Checksum present.  
01 = 8-bit Data Checksum present.  
10 = 16-bit Data Checksum present.  
11 = 32-bit Data Checksum present.

10.6.1.1.8 Data Type. This frame (1 byte) contains a value representing the type and format of the data. All values not used to define a data type are reserved for future data type growth:

0x00 = Computer Generated Data: Format 0 - (user defined)  
0x01 = Computer Generated Data: Format 1 - (setup record)  
0x09 = PCM Data: Format 1  
0x11 = Time Data: Format 1  
0x19 = MIL-STD-1553 Data: Format 1  
0x21 = Analog Data: Format 1  
0x29 = Discrete Data: Format 1  
0x30 = Message Data: Format 0  
0x38 = ARINC 429 Data: Format 0  
0x40 = Video Data: Format 0 - (MPEG-2 Video)  
0x48 = Image Data: Format 0 - (Image)  
0x50 = UART Data: Format 0

10.6.1.1.9 Relative Time Counter. This frame (6 bytes) contains a value representing the Relative Time Counter.



This is a free-running 10 MHz binary counter represented by 48 bits common to all data channels. The counter shall be derived from an internal crystal oscillator and shall remain free running during each recording session. The applicable data bit to which the 48-bit value applies will be defined in each data type section.

10.6.1.1.10 Header Checksum. This field (2 bytes) contains a value representing a 16-bit arithmetic sum of all header bytes excluding the Header Checksum Word.

10.6.1.2 Packet Secondary Header (optional). The length of the Packet Secondary Header is fixed at 12 bytes (96 bits). The Packet Secondary Header is optional and, when enabled, shall consist of the following three fields positioned contiguously in the following sequence:

10.6.1.2.1 Time. This field (8 bytes) contains the value representing Time in the format indicated by bits 2 and 3 of the Packet Flags as specified in paragraph 10.6.1.1.7.

10.6.1.2.2 Reserved. This field (2 bytes) is reserved and shall be zero filled.

10.6.1.2.3 Secondary Header Checksum. This field (2 bytes) contains a value representing a 16-bit arithmetic sum of all Secondary Header bytes, but excluding the Secondary Header Checksum Word.

10.6.1.3 Packet Body. The format of the data in the packet body is unique to each channel type. Detailed descriptions of the type-specific data formats found in packet bodies are described in subsequent sections of this document.

10.6.1.3.1 Channel Specific Data. This field (variable bytes) contains the number and contents of the Channel Specific Data field(s) depending on the Data Type field in the Packet Header. Channel Specific Data is mandatory for each data type and channel. The occurrence of Channel Specific Data is once per packet and precedes packet channel data.

10.6.1.3.2 Intra-Packet Time Stamp. This field (8 bytes) contains Time in either 48-bit relative format (plus 16 high-order zero bits) or 64-bit absolute format, as specified in the Packet Flags in the Packet Header. The intra-packet time stamps are only mandatory where defined by the data formats.

10.6.1.3.3 Intra-Packet Data Header. This field (variable bytes) contains additional status and format information pertaining to the data items that follow. The intra-packet data headers are only mandatory where defined by the data formats.



The Intra-Packet Time Stamp and the Intra-Packet Data Header are collectively called the Intra-Packet Header. In some cases an Intra-Packet Header may only have a time stamp (zero-length data header), while in other cases, the Intra-Packet Header only has a data header (zero-length time stamp). Some data types have no Intra-Packet Header. The Intra-Packet Header requirements are specified separately for each data type.

10.6.1.3.4 Data. This field (n bytes) contains valid data from a particular channel as defined within the data formats contained within this standard.

10.6.1.4 Packet Trailer. The packet trailer may contain Filler, a Data Checksum, both Filler and a Data Checksum, or neither Filler nor a Data Checksum. In the latter case, the packet trailer has zero length. The reason a packet trailer would have a zero length is best explained by understanding the reason for inserting Filler. The purpose of the Filler is to:

- a. keep all packets aligned on 32-bit boundaries (i.e., make all packet lengths a multiple of 4 bytes), and
- b. optionally, keep all packets from a particular channel the same length.

If both these requirements are already met without adding Filler, then Filler will not be added.

The inclusion of the Data Checksum is optional as well and is indicated by the Packet Flags setting. When included, the packet trailer contains either an 8-bit, 16-bit or 32-bit Data Checksum. Depending on the Packet Flags option selected, the Data Checksum is the arithmetic sum of all of the bytes (8-bits), words (16-bits) or long words (32-bits) in the packet, excluding the 24 bytes of Packet Header Words, Packet Secondary Header (if enabled) and the Data Checksum word. Stated another way, the Data Checksum includes everything in the packet body plus all added Filler.

10.6.1.4.1 Filler. This field (n bytes/bits) contains Filler to make the packet size a multiple of 4 bytes and (optionally) make all packets from a channel the same size.

10.6.1.4.2 8-Bit Data Checksum. This field (1 byte) contains a value representing an 8-bit arithmetic sum of the bytes in the packet (includes Channel Specific Data, Data, and Filler). Only inserted if Packet Flag bits 0 and 1 = 01.

10.6.1.4.3 16-Bit Data Checksum. This field (2 bytes) contains a value representing a 16-bit arithmetic sum of the words in the packet (includes Channel Specific Data, Data, and Filler) and is only inserted if Packet Flag bits 0 and 1 = 10.

10.6.1.4.1 32-Bit Data Checksum. This field (4 bytes) contains a value representing a 32-bit arithmetic sum of the long words in the packet (includes Channel Specific Data, Data, and Filler). Only inserted if Packet Flag bits 0 and 1 = 11.

10.6.2 PCM Data Packets, Format 1. A packet with PCM data has the basic structure shown in Figure [10-8](#). Note that the width of the structure is not related to any number of bits. This figure merely represents the relative placement of data in the packet.



PACKET HEADER
CHANNEL SPECIFIC DATA
(Optional) INTRA-PACKET TIME STAMP
(Optional) INTRA-PACKET DATA HEADER
MINOR FRAME DATA
(Optional) INTRA-PACKET TIME STAMP
(Optional) INTRA-PACKET DATA HEADER
MINOR FRAME DATA
(Optional) INTRA-PACKET TIME STAMP
(Optional) INTRA-PACKET DATA HEADER
MINOR FRAME DATA
(Optional) INTRA-PACKET TIME STAMP
(Optional) INTRA-PACKET DATA HEADER
MINOR FRAME DATA
(Optional) INTRA-PACKET TIME STAMP
(Optional) INTRA-PACKET DATA HEADER
MINOR FRAME DATA
:
(Optional) INTRA-PACKET TIME STAMP
(Optional) INTRA-PACKET DATA HEADER
MINOR FRAME DATA
PACKET TRAILER

Figure 10-8. General PCM Data Packet, Format 1.

The user may separately enable or disable word unpacking on each active PCM channel. Word unpacking will force the least significant bit of each word to be aligned on a 16-bit boundary. High-order filler bits are added to words, as necessary, to force alignment.

The user may separately enable or disable frame synchronizing on each active PCM channel. This provides a Throughput Mode that will transfer data to the packet without frame synchronization. Throughput Mode essentially disables all setup and packing/unpacking options for the packet, and just puts data in the packet as it is received.

10.6.2.1 PCM Packet Channel Specific Data. The packet body portion of each PCM packet begins with the Channel Specific Data, as shown in Figure [10-9](#).

<b>msb</b>										<b>lsb</b>
31	30	29	28	27	24	23	18	17		0
R	IPH	MA	MI	LOCKST	MODE	SYNCOFFSET				

Figure 10-9. PCM Packet Channel Specific Data format.

where:

Bits 17-0: Sync Offset (SYNCOFFSET): field contains an 18-bit binary value representing the Word offset into the major frame for the first data word in the packet. Not valid for Packed or Throughput Mode.

Bits 23-18: Mode (MODE): indicates the data packing mode.

Bits 23-21 are reserved.

Bit 20 indicates Throughput Data Mode.

0 = Throughput Data Mode not enabled.  
1 = Throughput Data Mode enabled.

Bit 19 indicates Packed Data Mode.

0 = Packed Data Mode not enabled.  
1 = Packed Data Mode enabled.

Bit 18 indicates Unpacked Data Mode.

0 = Unpacked Data Mode not enabled.  
1 = Unpacked Data Mode enabled.

Bits 27-24: Lock status (LOCKST): indicates the lock status of the frame synchronizer. Not valid for Throughput Mode.

Bits 27-26 indicate Minor Frame Status.

00 = Reserved.  
01 = Reserved.  
10 = Minor Frame Check (after losing Lock).  
11 = Minor Frame Lock.

Bits 25-24 indicate Major Frame Status.

00 = Minor Frames only.  
01 = Reserved.  
10 = Major Frame Check (after losing Lock).  
11 = Major Frame Lock.

Bit 28: Minor Frame Indicator (MI) indicates if the first word in the packet is the beginning of a minor frame. Not valid for throughput mode.

- 0 = First word is not the beginning of a minor frame.  
1 = First word is the beginning of a minor frame.
- Bit 29: Major Frame Indicator (MA): indicates if the first word in the packet is the beginning of a major frame. Not valid for Throughput Mode.
- 0 = First word is not the beginning of a major frame.  
1 = First word is the beginning of a major frame.
- Bit 30: Intra-Packet Header (IPH): indicate if Intra-Packet Headers (Intra-Packet Time Stamp and Intra-Packet Data Header) are inserted before each minor frame. Intra-Packet Headers are only optional because of the mode selection. This determines whether Intra-Packet Headers are included or omitted.
- 0 = Intra-Packet Headers are omitted for Throughput Mode.  
1 = Intra-Packet Headers are required for Packed Data and Unpacked Data modes.
- Bit 31: Reserved.

10.6.2.2 PCM Packet Body. After the Channel Specific Data, the PCM data and Intra-Packet Headers are inserted in the packet in integral numbers of minor or major frames, unless the packet is in Throughput Mode. In Throughput Mode, there is no frame or word alignment to the packet data and no Intra-Packet Headers are inserted in the data.

10.6.2.2.1 PCM Data in Unpacked Mode. In Unpacked Mode, packing is disabled and each data word is padded with the number of Filler bits necessary to align the first bit of each word with the next 16-bit boundary in the packet. For example, 4 pad bits are added to 12 bit words, 6 pad bits are added to 10 bit words, etc.

Minor frame sync patterns larger than 16 bits are divided into two words of packet data. If the sync pattern has an even number of bits, then it will be divided in half and placed in two packet words. For example, a 24-bit sync pattern is broken into two 12-bit words with 4 bits of pad in each word. If the sync pattern has an odd number of bits, it is broken into two words with the second word having one-bit more of the sync pattern. For example, if the minor sync pattern is 25 bits, then the first sync word is 12 bits of sync pattern plus 4 bits of pad, and the second sync word is 13 bits of sync pattern plus 3 bits of pad.

Given PCM frames with a 24-bit minor sync pattern and n data words where the bit lengths of data words 1, 2, and 3 are 12, 16, and 8, respectively. The resultant PCM packets are as shown in Figure [10-10](#):

<b>msb</b> <b>15</b>	<b>lsb</b> <b>0</b>
PACKET HEADER	
CHANNEL SPECIFIC DATA (BITS 15-0)	
CHANNEL SPECIFIC DATA (BITS 31-16)	
INTRA-PACKET TIME STAMP (BITS 15-0)	
INTRA-PACKET TIME STAMP (BITS 31-16)	
INTRA-PACKET TIME STAMP (BITS 47-32)	
INTRA-PACKET TIME STAMP (BITS 63-48)	
INTRA-PACKET DATA HEADER (BITS 15-0)	
4-BITS PAD	12-BITS SYNC (BITS 23-12)
4-BITS PAD	12-BITS SYNC (BITS 11-0)
4-BITS PAD	12-BITS WORD 1 DATA
16-BITS WORD 2 DATA	
8-BITS PAD	8-BITS WORD 3 DATA
:	
WORD <i>n</i> DATA BITS + PAD IF NEEDED	
INTRA-PACKET TIME STAMP ( BITS 15-0)	
INTRA-PACKET TIME STAMP ( BITS 31-16)	
INTRA-PACKET TIME STAMP ( BITS 47-32)	
INTRA-PACKET TIME STAMP ( BITS 63-48)	
INTRA-PACKET DATA HEADER ( BITS 15-0)	
:	
REPEAT FOR EACH MINOR FRAME	
:	
PACKET TRAILER	

Figure 10-10. PCM Data – Unpacked Mode Sample Packet.

10.6.2.2.2 PCM Data in Packed Mode. In Packed Mode, packing is enabled and pad is not added to each data word. However, if the number of bits in the minor frame is not an integer multiple of 16, then ‘Y’ Filler bits will be added to the end of each minor frame of bit length L.  $Y = 16 - \text{MOD}(L,16)$ , or 16 minus the integer remainder when L is divided by 16. In packed mode, the PCM stream is minor frame synchronized so the first data bit in the packet is the first data bit of a minor frame. If  $X = 16 - Y$ , then the resultant PCM packets are as shown in Figure 10-11:

<b>msb</b> <b>15</b>	<b>lsb</b> <b>0</b>
PACKET HEADER	
CHANNEL SPECIFIC DATA (BITS 15-0)	
CHANNEL SPECIFIC DATA (BITS 31-16)	
INTRA-PACKET TIME STAMP ( BITS 15-0)	
INTRA-PACKET TIME STAMP ( BITS 31-16)	
INTRA-PACKET TIME STAMP ( BITS 47-32)	
INTRA-PACKET TIME STAMP ( BITS 63-48)	
INTRA-PACKET DATA HEADER ( BITS 15-0)	
DATA BITS 0 to 16	
DATA BITS 16 to 31	
DATA BITS 32 to 47	
:	
Y FILLER BITS	X DATA BITS
INTRA-PACKET TIME STAMP ( BITS 15-0)	
INTRA-PACKET TIME STAMP ( BITS 31-16)	
INTRA-PACKET TIME STAMP ( BITS 47-32)	
INTRA-PACKET TIME STAMP ( BITS 63-48)	
INTRA-PACKET DATA HEADER ( BITS 15-0)	
:	
REPEAT FOR EACH MINOR FRAME	
:	
PACKET TRAILER	

Figure 10-11. PCM Data – Packed Mode Sample Packet.

10.6.2.2.3 PCM Data in Throughput Mode. In Throughput mode, the PCM data are not frame synchronized so the first data bit in the packet can be any bit in the major frame. The resultant PCM packets are as shown in Figure 10-12. Only bit 20 of the Channel Specific Data word is set to one, indicating Throughput Mode. All other bits of the Channel Specific Data word are undefined and shall be set to zero.

<b>msb</b>	<b>lsb</b>
<b>15</b>	<b>0</b>
PACKET HEADER	
CHANNEL SPECIFIC DATA (BITS 15-0)	
CHANNEL SPECIFIC DATA (BITS 31-16)	
DATA BITS 0 to 15	
DATA BITS 16 to 31	
DATA BITS 32 to 47	
:	
PACKET TRAILER	

Figure 10-12. PCM Data – Throughput Mode sample packet.

10.6.2.2.4 PCM Intra-Packet Header. When recording in Packed or Unpacked Mode, all PCM minor frames shall include an Intra-Packet Header containing a 64-bit Intra-Packet Time Stamp and a 16-bit Intra-Packet Data Header, which is inserted immediately before the minor frame sync pattern. The length of the Intra-Packet Header is fixed at 10 bytes (80-bits) positioned contiguously, in the following sequence (see Figure 10-13):

<b>msb</b>	<b>lsb</b>
31	0
15	12 11
TIME (LSLW)	
TIME (MSLW)	
LOCKST	
RESERVED	

Figure 10-13. PCM Intra-Packet header.

10.6.2.2.4.1 Intra-Packet Time Stamp. This field (8 bytes) indicates the time tag of the PCM minor frame. It is not valid for Throughput Mode. The first long word bits 31-0 and second long word bits 31-0 indicate the following values:

- The 48-bit Relative Time Counter that corresponds to the first data bit of the minor frame with bits 31 to 16 in the second long word zero filled; or

- Packet Secondary Header Time Type, if enabled by bit 6 in the Packet Header Flags (paragraph 10.6.1.1.7), corresponds to the time format indicated by bits 2 and 3 in the Packet Secondary Header Time (paragraph [10.6.1.1.7](#)) and to the first data bit of the minor frame.

#### 10.6.2.2.4.2 Intra-Packet Data Header

Bits 11-0: Reserved.

Bits 15-12: Lock status (LOCKST): indicates the Lock Status of the frame synchronizer for each minor frame.

Bits 15-14 indicate Minor Frame Status.

- 00 = Reserved.
- 01 = Reserved.
- 10 = Minor Frame Check (after losing Lock).
- 11 = Minor Frame Lock.

Bits 13-12 indicate Major Frame Status.

- 00 = Minor Frames only.
- 01 = Reserved.
- 10 = Major Frame Check (after losing Lock).
- 11 = Major Frame Lock.

10.6.3 Time Data Packets, Format 1. Time is treated like another data channel. A single Time Data Packet is inserted into the multiplexed data stream at least with the rate equal to the time code frame rate or resolution of the time type format. The 48-bit Relative Time Counter shall be captured for insertion into the Time Data Packet Header per the following:

10.6.3.1 IRIG Time Type Formats. At precisely the exact moment the IRIG “on-time” mark is received by the hardware indicating the start of a new IRIG time code frame, the 48-bit Relative Time Counter shall be captured for insertion into the Time Data Packet Header.

10.6.3.2 All Non-IRIG Time Type Formats. At precisely the exact moment of any 10-ms absolute time change received by the hardware, the 48-bit Relative Time Counter shall be captured for insertion into the Time Packet Data Header. After capture of the 48-bit Relative Time Counter, the decoded absolute time from the time code frame is inserted into the data portion of the Time Packet.



A Time Data Packet shall be the first dynamic data packet at the start of each recording. Only static Computer Generated Data packets may precede the Time Data Packet in the recording.

A packet with time data has the basic structure shown in Figure 10-14. Note that the width of the structure is not related to any number of bits. This drawing merely represents the relative placement of data in the packet. Time Packets do not have Intra-Packet Headers.

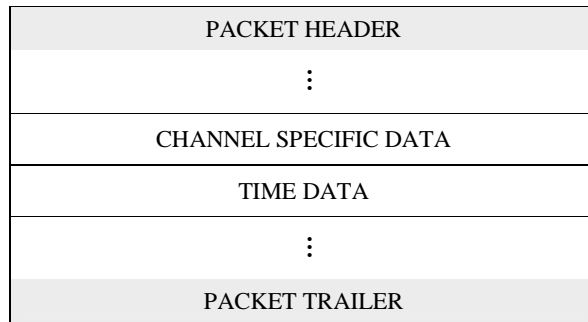

Figure 10-14. General Time Data Packet, Format 1.

10.6.3.3 Time Packet Channel Specific Data. The Packet Body portion of each Time Data Packet begins with a Channel Specific Data Word formatted as described in Figure 10-15.

<u>msb</u>						lsb
31	12	11	8	7	4	3
RESERVED		DATE		FMT		EXT
						0

Figure 10-15. Time Data Packet Channel Specific Data Word format.



where:

Bits 3-0: External Time (EXT): indicate if the external time source is present.

Bit 0 indicates if the external time source is present.

0 = External time is not present.

1 = External time present.

Bits 3-1 are reserved

Bits 7-4: Time Format (FMT): indicates the Time Data Packet format. All bit patterns not used to define a time format type are reserved for future data type growth.

0x0 = IRIG-B.

0x1 = IRIG-A.

0x2 = IRIG-G.

0x3 = Internal real-time clock.

0x4 = UTC time from GPS.

0x5 = Native GPS time.

0x6 thru 0xF = Reserved.

Bits 11-8: Date Format (DATE): indicates the Date Format. All bit patterns not used to define a date format type are reserved for future growth.

Bit 9 indicates Date Format.

0 = IRIG day available.

1 = Month and Year available.

Bit 8 indicates if this is a leap year.

0 = Not a leap year.

1 = Is a leap year.

Bits 11-10 are reserved.

Bits 31-12: Reserved.

10.6.3.4 **Time Packet Body.** After the Channel Specific Data Word, the time data words are inserted in the packet in Binary Coded Decimal (BCD) format as shown in [Figures 10-16a](#) and [10-16b](#).

msb										lsb																																							
15															12					11					8					7					4					3					0				
0					TSn					Sn					Hmn					Tmn																													
0					0					THn					Hn					0					TMn					Mn																			
0					0					0					0					0					0					HDn					TDn					Dn									

Figure 10-16a. Time Data - Packet Format, Day Format.

msb										lsb																																							
15															12					11					8					7					4					3					0				
0					TSn					Sn					Hmn					Tmn																													
0					0					THn					Hn					0					TMn					Mn																			
0					0					0					TOn					On					TDn					Dn																			
0					0					OYn					HYn					TYn					Yn																								

Figure 10-16b. Time Data - Packet Format, Day, Month, And Year Format.

Legend

Tmn	Tens of milliseconds	TDn	Tens of days
Hmn	Hundreds of milliseconds	HDn	Hundreds of Days
Sn	Units of seconds	On	Units of Months
TSn	Tens of Seconds	TOn	Tens of Months
Mn	Units of minutes	Yn	Units of Years
TMn	Tens of minutes	TYn	Tens of Years
Hn	Units of hours	HYn	Hundreds of Years
THn	Tens of Hours	OYn	Thousands of Years
Dn	Units of Days	0	Always zero

10.6.4 **MIL-STD-1553 Bus Data Packets, Format 1.** MIL-STD-1553 BUS data is packetized in Message Mode, where each 1553 bus “transaction” is recorded as a “message.” A four-item Intra-Packet Data Header is inserted prior to each transaction. A transaction is a BC-to-RT, RT-to-BC, or RT-to-RT word sequence, starting with the command word and including all data and status words that are part of the transaction, or a mode code word broadcast. Multiple messages may be encoded into the data portion of a single packet.

10.6.4.1 **MIL-STD-1553 Packet Channel Specific Data.** The packet body portion of each MIL-STD-1553 Data Packet begins with a Channel Specific Data word formatted as described in [Figure 10-17](#).

msb										lsb																													
31															30					29					24					23					0				
TTB					RESERVED					MSGCOUNT																													

Figure 10-17. MIL-STD-1553 Packet Body Channel Specific Data Word format.

where:

- Bits 23-0: Message Count (MSGCOUNT): indicates the binary value of the number of messages included in the packet. An integral number of complete messages will be in each packet.
- Bits 29-24: Reserved.
- Bits 31-30: Time Tag Bits (TTB): indicates which bit of the MIL-STD-1553 message the Intra-Packet Header time tags.
  - 00 = Last bit of the last word of the message.
  - 01 = First bit of the first word of the message.
  - 10 = Last bit of the first (command) word of the message.
  - 11 = Reserved.

10.6.4.2 MIL-STD-1553 Packet Body. A packet with n-number of MIL-STD-1553 messages has the basic structure shown in Figure 10-18. Note that the width of the structure is not related to any number of bits. This figure merely represents the relative placement of data in the packet.

PACKET HEADER
CHANNEL SPECIFIC DATA
INTRA-PACKET TIME STAMP FOR MESSAGE 1
INTRA-PACKET DATA HEADER FOR MESSAGE 1
MESSAGE 1
INTRA-PACKET TIME STAMP FOR MESSAGE 2
INTRA-PACKET DATA HEADER FOR MESSAGE 2
MESSAGE 2
:
INTRA-PACKET TIME STAMP FOR MESSAGE n
INTRA-PACKET DATA HEADER FOR MESSAGE n
MESSAGE n
PACKET TRAILER

Figure 10-18. MIL-STD-1553 Data Packet, Format 1.

10.6.4.2.1 MIL-STD-1553 Intra-Packet Header. After the Channel Specific Data, the MIL-STD-1553 Data are inserted into the packet in messages. Each MIL-STD-1553 message is preceded by an Intra-Packet Header consisting of an Intra-Packet Time Stamp and an Intra-Packet Data Header.

10.6.4.2.1.1 MIL-STD-1553 Intra-Packet Time Stamp. This frame (8 bytes) indicates the time tag of the MIL-STD-1553 message as follows.

- The 48-bit Relative Time Counter that corresponds to the data bit indicated in the MIL-STD-1553 Channel Specific Data, Time Tag Bits (paragraph 10.6.4.1) with bits 31 to 16 in the second long word zero filled; or
- The Absolute Time, if enabled by bit 6 in the Packet Header Flags (paragraph 10.6.1.1.7), corresponds to the time format indicated by bits 2 and 3 in the Packet Header Flags (paragraph 10.6.1.1.7) and to the data bit indicated in the MIL-STD-1553 Channel Specific Data, Time Tag Bits (paragraph 10.6.4.1).

10.6.4.2.1.2 MIL-STD-1553 Intra-Packet Data Header. The length of the Intra-Packet Data Header is fixed at 6 bytes (48-bits) positioned contiguously in the following sequence as shown in Figure 10-19.

<b>msb</b>	<b>lsb</b>
15	0
BLOCK STATUS WORD	
GAP TIMES WORD	
LENGTH WORD	

Figure 10-19. MIL-STD-1553 Intra-Packet Data Header.

10.6.4.2.1.2.1 Block Status Word (BSW). Bits 15-0 contain the Block Status Word for both the message type and whether any 1553 bus protocol errors occurred during the message transfer. The Block Status Word bit definitions are as shown in Figure 10-20.

<b>msb</b>															<b>lsb</b>
15-14	13	12	11	10	9	8	7	6	5	4	3	2	1	0	
R	BID	ME	RR	FE	TM	R	R	R	LE	SE	WE	R	R	R	

Figure 10-20. Block Status Word bit definitions.

where:

- Bits 15-14: Reserved (R).
- Bit 13: Bus ID (BID): indicates the bus ID for the message.  
0 = Message was from Channel A.  
1 = Message was from Channel B.
- Bit 12: Message Error (ME): indicates a message error was encountered.  
0 = No message error.  
1 = Message error.
- Bit 11: RT to RT transfer (RR): indicates a RT to RT transfer; message begins with two command words.  
0 = No RT to RT transfer.  
1 = RT to RT transfer.
- Bit 10: Format Error (FE): indicates a frame error.  
0 = No format error.  
1 = Format error.
- Bit 9: Response Time Out (TM): indicates a response time out occurred.  
0 = No response time out.  
1 = Response time out.
- Bits 8-6: Reserved (R).
- Bit 5: Word Count Error (LE): indicates a word count error occurred.  
0 = No word count error.  
1 = Word count error.
- Bit 4: Sync Type Error (SE): indicates an incorrect sync type occurred.  
0 = No sync type error.  
1 = Sync type error.
- Bit 3: Invalid Word Error (WE): indicates an invalid word error occurred.  
0 = No invalid word error.  
1 = Invalid word error.
- Bits 2-0: Reserved (R).

10.6.4.2.1.2.2 Gap Times Word. The Gap Times Word indicates the number of tenths of microseconds in length of the internal gaps within a single transaction. For most messages, only GAP1 is meaningful. It measures the time between the command or data word and the first (and only) status word in the message. For RT-to-RT messages, GAP2 measures the time between the last data word and the second status word. The Gap Times Word bit definitions are as shown in Figure [10-21](#).

<b>msb</b>	8	7	<b>lsb</b>
15			0
GAP2		GAP1	

Figure 10-21. Gap Times Word bit definitions.

	<p>Gap measurements shall be made IAW MIL-STD-1553 response time measurements from the mid-bit zero crossing of the parity bit of the last word to the mid-zero crossing of the sync of the status word.</p>
--	--

10.6.4.2.1.2.3 Length Word. The Length of the message is the total number of bytes in the message. A message consists of command words, data words, and status words.

10.6.4.3 Packet Format. Unless an error occurred, as indicated by one of the error flags in the block status word, the first word following the length should always be a command word. The resultant packets have the format shown in Figure [10-22](#).

<b>msb</b>	<b>lsb</b>
15	0
PACKET HEADER	
CHANNEL SPECIFIC DATA (BITS 15-0)	
CHANNEL SPECIFIC DATA (BITS 31-16)	
INTRA-PACKET TIME STAMP FOR MSG 1 (BITS 15-0)	
INTRA-PACKET TIME STAMP FOR MSG 1 (BITS 31-16)	
INTRA-PACKET TIME STAMP FOR MSG 1 (BITS 47-32)	
INTRA-PACKET TIME STAMP FOR MSG 1 (BITS 63-48)	
INTRA-PACKET DATA HEADER FOR MSG 1 (BITS 15-0)	
INTRA-PACKET DATA HEADER FOR MSG 1 (BITS 31-16)	
INTRA-PACKET DATA HEADER FOR MSG 1 (BITS 47-32)	
COMMAND WORD	
COMMAND, STATUS, OR DATA WORD	
DATA OR STATUS WORD	
:	
DATA OR STATUS WORD	
INTRA-PACKET TIME STAMP FOR MSG 2 (BITS 15-0)	
INTRA-PACKET TIME STAMP FOR MSG 2 (BITS 31-16)	
INTRA-PACKET TIME STAMP FOR MSG 2 (BITS 47-32)	
INTRA-PACKET TIME STAMP FOR MSG 2 (BITS 63-48)	
INTRA-PACKET DATA HEADER FOR MSG 2 (BITS 15-0)	
INTRA-PACKET DATA HEADER FOR MSG 2 (BITS 31-16)	
INTRA-PACKET DATA HEADER FOR MSG 2 (BITS 47-32)	
COMMAND WORD	
COMMAND, STATUS, OR DATA WORD	
DATA OR STATUS WORD	
:	
DATA OR STATUS WORD	
:	
INTRA-PACKET TIME STAMP FOR MSG n (BITS 15-0)	
INTRA-PACKET TIME STAMP FOR MSG n (BITS 31-16)	
INTRA-PACKET TIME STAMP FOR MSG n (BITS 47-32)	
INTRA-PACKET TIME STAMP FOR MSG n (BITS 63-48)	
INTRA-PACKET DATA HEADER FOR MSG n (BITS 15-0)	
INTRA-PACKET DATA HEADER FOR MSG n (BITS 31-16)	
INTRA-PACKET DATA HEADER FOR MSG n (BITS 47-32)	
COMMAND WORD	
COMMAND OR DATA, WORD	
DATA OR STATUS WORD	
:	
DATA OR STATUS WORD	
PACKET TRAILER	

Figure 10-22. MIL-STD-1553 Data Packet, Format 1.

10.6.5 Analog Data Packets, Format 1. An illustration of the generic packet structure for analog data is shown in Figure 10-23. An Analog Data Packet will contain a Channel Specific Data word for each subchannel of analog data sampled within that packet. This will be followed by at least one complete sampling schedule of data. A sampling schedule is defined as a sampling sequence in which each subchannel, described by a Channel Specific Data word, is sampled at least once. In many cases, due to simultaneous sampling rules and varied sampling rates (see 10.6.5.2), a particular subchannel will be sampled more than once during a sampling schedule. In addition, multiple complete sampling schedules may be included in a single packet. For these reasons, the number of Channel Specific Data words will usually be less than the number of samples. Figure 10-23 depicts the generic packet data structure for M data subchannels and a single sampling schedule that has a length N. Note that the width of the structure is not related to any number of bits and is merely presented to show the relative placement of words within the packet.

PACKET HEADER
:
CHANNEL SPECIFIC DATA WORD, SUBCHANNEL 1
CHANNEL SPECIFIC DATA WORD, SUBCHANNEL 2
:
CHANNEL SPECIFIC DATA WORD, SUBCHANNEL M
SAMPLE 1
SAMPLE 2
:
SAMPLE N
:
PACKET TRAILER

Figure 10-23. Generic Analog Data Packet, Format 1.



The Packet Header Time in an Analog Data Packet shall correspond to the first data sample in the packet. There are no Intra-Packet Headers in Analog Data Packets.



10.6.5.1 Analog Packet Channel Specific Data. The Packet Body portion of each Analog Packet begins with the Channel Specific Data Word(s). Each subchannel that is sampled within the packet sampling schedule must have a Channel Specific Data word within the packet. Channel Specific Data words for Analog Data Packets are formatted as shown in Figure 10-24.

<b>msb</b>						<b>lsb</b>					
31	28	27	24	23	16	15	8	7	2	1	0
RESERVED		FACTOR		TOTCHAN		SUBCHAN		LENGTH		MODE	

Figure 10-24. Analog Data Packets, Channel Specific Data word format.

where:

Bits 1-0: Mode: indicates alignment and packing modes of the analog data. Bit 0 is the packing bit, bit 1 is the alignment bit (X = don't care). When Totchan (defined below) is more than 1, the Mode must be the same for all subchannels in a single packet.

- X0 = data is packed
- 01 = data is unpacked, lsb padded
- 11 = data is unpacked, msb padded

Bits 7-2: Length: indicates a binary value representing the number of bits in the analog to digital converter (A/D).

- 000000 = sixty-four bit samples
- 000001 = one bit samples
- :
- :
- 001000 = eight bit samples
- :
- 001100 = twelve bit samples
- :

Bits 15-8: Subchan: indicates a binary value representing the number of the analog subchannel. When an analog packet contains data from more than one subchannel, the Channel Specific Data words must be inserted into the packet in ascending subchannel number as identified by this Subchan field. The Subchan values in these Channel Specific Data words need not be contiguous (see Totchan) but they must be in ascending decimal numerical order with the exception that subchannel 0 (256) is last.

- 0x01 = Subchannel 1
- 0x02 = Subchannel 2
- :
- 0x00 = Subchannel 256

Bits 23-16: Totchan: indicates the total number of analog subchannels in the packet (and the number of Channel Specific Data words in the packet). This Totchan field must be the same value in all Channel Specific Data words in a single packet. The Totchan value may be less than the largest subchan value. This can happen when a multi-channel analog input device has some of its subchannels disabled (turned off) for a specific recording. For example, if an analog input device has eight subchannels and not all eight are active, an analog data packet may have three subchannels (Totchan = 3) numbered 4, 7, and 8 (enabled Subchan = 4, 7, 8.) The number of subchannels (Totchan) and the subchannel number for each active subchannel (Subchan) in a packet are identified in the accompanying TMATS (Computer Generated Data, Format 1) packet.

0x00 = 256 subchannels

0x01 = 1 subchannel

0x02 = 2 subchannels

:

Bits 27-24: Factor: is the exponent of the power of 2 sampling rate factor denominator for the corresponding subchannel (described in [10.6.5.2](#)) in the range 0 to 15. (The sampling rate factor numerator is always 1.)

0x0 = sampling rate factor denominator  $2^0 = 1 \Rightarrow$  factor = 1/1

0x1 = sampling rate factor denominator  $2^1 = 2 \Rightarrow$  factor = 1/2

0x2 = sampling rate factor denominator  $2^2 = 4 \Rightarrow$  factor = 1/4

:

0xF = sampling rate factor denominator  $2^{15} = 32768 \Rightarrow$  factor = 1/32768

Bits 31-28: Reserved.

10.6.5.2 Analog Samples. To preserve timing relationships and allow for accurate reconstruction of the data, a simultaneous sampling scheme shall be employed. The highest sampling rate required shall define the primary simultaneous sampling rate within the packet. The primary simultaneous sampling rate is identified in the Telemetry Attributes Transfer Standard (TMATS) file describing the attributes of the analog data packet. The rate at which the other subchannels are sampled is then defined by the sampling factor (1, 1/2, 1/4, 1/8, 1/16, .....1/32768) for each subchannel. As an example, a sampling factor of 1/4 would yield that subchannel being sampled at one-fourth the primary simultaneous sampling rate and a sampling factor of 1 would yield that subchannel being sampled at the primary simultaneous sampling rate.

Directly following the Channel Specific Data word(s), at least one complete sampling schedule shall be inserted in the packet. The samples, within the sampling sequence, may be inserted either unpacked, MSB-Packed, or LSB-Packed as described in paragraph [10.6.5.2.1](#) and [10.6.5.2.2](#). In either case, one or more subchannels may be included in a single packet. When

multiple subchannels are encapsulated into a single packet, the subchannel with the highest sampling rate requirement defines the primary simultaneous sampling rate. The rate at which the other subchannels are sampled is defined by the sampling factor (contained within the Channel Specific Data words). Sampling factors are defined as:

$$\left(\frac{1}{2^K}\right) * X$$

where:

$K = 0, 1, 2, 3, 4, 5, \dots$  of the primary simultaneous sampling rate,  $X$ .

The subchannels are then sampled and ordered such that the highest sample rate:

1 \*  $X$  subchannel(s) appear in every simultaneous sample,

$\left(\frac{1}{2}\right) * X$  in every 2nd simultaneous sample,

$\left(\frac{1}{4}\right) * X$  in every 4th simultaneous sample

and so on until all the subchannels are sampled, resulting in a complete sampling schedule of all subchannels described by the Channel Specific Data words. In doing so, the total number of simultaneous samples (not the total number of samples) will equal the denominator of the smallest sampling factor and all subchannels are sampled in the last simultaneous sample.

For example, a packet with six subchannels with Sampling Factors 1/2, 1/8, 1, 1/2, 1, and 1/8, respectively, will yield a sampling sequence within the data packet as follows:

Simultaneous Sample 1:	Subchannel 3
Simultaneous Sample 1:	Subchannel 5
Simultaneous Sample 2:	Subchannel 1
Simultaneous Sample 2:	Subchannel 3
Simultaneous Sample 2:	Subchannel 4
Simultaneous Sample 2:	Subchannel 5
Simultaneous Sample 3:	Subchannel 3
Simultaneous Sample 3:	Subchannel 5
Simultaneous Sample 4:	Subchannel 1
Simultaneous Sample 4:	Subchannel 3
Simultaneous Sample 4:	Subchannel 4
Simultaneous Sample 4:	Subchannel 5
Simultaneous Sample 5:	Subchannel 3
Simultaneous Sample 5:	Subchannel 5

Simultaneous Sample 6:	Subchannel 1
Simultaneous Sample 6:	Subchannel 3
Simultaneous Sample 6:	Subchannel 4
Simultaneous Sample 6:	Subchannel 5
Simultaneous Sample 7:	Subchannel 3
Simultaneous Sample 7:	Subchannel 5
Simultaneous Sample 8:	Subchannel 1
Simultaneous Sample 8:	Subchannel 2
Simultaneous Sample 8:	Subchannel 3
Simultaneous Sample 8:	Subchannel 4
Simultaneous Sample 8:	Subchannel 5
Simultaneous Sample 8:	Subchannel 6

Notice that the denominator of the smallest sampling factor defined the number of simultaneous samples within the packet (in this example 8). However, the total number of samples within the sampling schedule does not have to equal the number of simultaneous samples (in this example 26). Also notice that all subchannels are sampled during the last simultaneous sample. The order of the subchannel samples in each Simultaneous Sample is ascending by subchannel number.

Any number of **complete** sampling schedules may be placed within a packet so that the maximum packet length is not exceeded. The TMATS file identifies the number of samples contained within each packet.

10.6.5.2.1 Unpacked Mode. In Unpacked Mode, packing is disabled, and each sample is padded with the number of bits necessary to align each word with the next 16-bit boundary in the packet. Four pad bits are added to 12-bit words, eight pad bits are added to 8-bit words, etc. All pad bits shall be zero.

To illustrate msb packing, given M analog subchannels mapping into N samples for the special case of all samples having bit lengths of 12 bits, the resultant analog packets with msb padding have the form shown in Figure [10-25](#).

<b>msb</b>	<b>lsb</b>
15	0
PACKET HEADER	
⋮	
CHANNEL SPECIFIC DATA WORD, SUBCHANNEL 1 (BITS 15-0)	
CHANNEL SPECIFIC DATA WORD, SUBCHANNEL 1 (BITS 31-16)	
CHANNEL SPECIFIC DATA WORD, SUBCHANNEL 2 (BITS 15-0)	
CHANNEL SPECIFIC DATA WORD, SUBCHANNEL 2 (BITS 31-16)	
⋮	
CHANNEL SPECIFIC DATA WORD, SUBCHANNEL M (BITS 15-0)	
CHANNEL SPECIFIC DATA WORD, SUBCHANNEL M (BITS 31-16)	
4-PAD BITS	SAMPLE 1, 12-DATA BITS
4-PAD BITS	SAMPLE 2, 12-DATA BITS
4-PAD BITS	SAMPLE 3, 12-DATA BITS
⋮	
4-PAD BITS	SAMPLE N, 12-DATA BITS
⋮	
PACKET TRAILER	

Figure 10-25. Analog Data Packet – msb Unpacked Mode.

To illustrate lsb packing, given M analog subchannels mapping into N samples for the special case of all samples having bit lengths of 12 bits, the resultant analog packets with lsb padding have the form shown in Figure 10-26.

<b>msb</b>	<b>lsb</b>
15	0
PACKET HEADER	
⋮	
CHANNEL SPECIFIC DATA WORD, SUBCHANNEL 1 (BITS 15-0)	
CHANNEL SPECIFIC DATA WORD, SUBCHANNEL 1 (BITS 31-16)	
CHANNEL SPECIFIC DATA WORD, SUBCHANNEL 2 (BITS 15-0)	
CHANNEL SPECIFIC DATA WORD, SUBCHANNEL 2 (BITS 31-16)	
⋮	
CHANNEL SPECIFIC DATA WORD, SUBCHANNEL M (BITS 15-0)	
CHANNEL SPECIFIC DATA WORD, SUBCHANNEL m (BITS 31-16)	
SAMPLE 1, 12-DATA BITS	4-PAD BITS
SAMPLE 2, 12-DATA BITS	4-PAD BITS
SAMPLE 3, 12-DATA BITS	4-PAD BITS
⋮	
SAMPLE N, 12-DATA BITS	4-PAD BITS
⋮	
PACKET TRAILER	

Figure 10-26. Analog Data Packet – lsb Unpacked Mode.

10.6.5.2.2 Packed Mode. In packed mode, packing is enabled and padding is not added to each data word. However, if the number of bits in the packet are not an integer multiple of 16, then ‘Y’ Filler bits will be used to msb fill the last data word to force alignment on a 16-bit boundary. ‘Y’ is sixteen (16) minus the integer remainder of L, the total number of data bits in the packet, divided by 16 and is mathematically expressed as

$$Y = 16 - (\text{MODULUS}\{L,16\})$$

To illustrate msb filling, given M analog subchannels mapping into N samples for the special case of all samples having bit lengths of 12 bits, the resultant analog packets with Filler bits at the end of the Nth sample have the form shown in Figure 10-27.

msb	lsb
15	0
PACKET HEADER	
:	
CHANNEL SPECIFIC DATA WORD, SUBCHANNEL 1 (BITS 15-0)	
CHANNEL SPECIFIC DATA WORD, SUBCHANNEL 1 (BITS 31-16)	
CHANNEL SPECIFIC DATA WORD, SUBCHANNEL 2 (BITS 15-0)	
CHANNEL SPECIFIC DATA WORD, SUBCHANNEL 2 (BITS 31-16)	
:	
CHANNEL SPECIFIC DATA WORD, SUBCHANNEL M (BITS 15-0)	
CHANNEL SPECIFIC DATA WORD, SUBCHANNEL M (BITS 31-16)	
SAMPLE 2 (BITS 3-0)	SAMPLE 1 (BITS 11-0)
SAMPLE 3 (BITS 7-0)	SAMPLE 2 (BITS 11-4)
:	:
Y FILLER BITS	SAMPLE N (BITS 11-0)
:	
:	
PACKET TRAILER	

Figure 10-27. Analog Data Packet – Packed Mode packet.

10.6.6 Discrete Data Packets, Format 1. A packet with Discrete data has the basic structure shown in Figure 10-28. Note that the width of the structure is not related to any number of bits. This drawing is merely to show the relative placement of data in the packet. One to 32 discrete states may be recorded for each event.



10.6.6.2 Discrete Data. After the Channel Specific Data, the Discrete Data is inserted in the packet. Discrete data is described as Events (Figure 10-30). Each event includes the Event State for each discrete input and the corresponding intra-packet time. The event state is a 32-bit word that provides the logical state of each discrete input.

<b>msb</b>								<b>lsb</b>
31	30						1	0
D31	D30			...			D1	D0

Figure 10-30. Discrete Data Event State word format.

where:

Bits 31-0: Discrete Event Bits indicate the states of the discrete event bits.

Bit 0 indicates Discrete 0 (D0) state.

- 0 = discrete 0 is at state 0.
- 1 = discrete 0 is at state 1.

Bit 1 indicates Discrete 1 (D1) state.

- 0 = discrete 1 is at state 0.
- 1 = discrete 1 is at state 1.

⋮

Bit 31 indicates Discrete 31 (D31) state.

- 0 = discrete 31 is at state 0.
- 1 = discrete 31 is at state 1.

10.6.6.2.1 Discrete Event Intra-Packet Header. All discrete events shall include an Intra-Packet Header consisting of an Intra-Packet Time Stamp only, which is inserted immediately before the discrete event. The length of the Intra-Packet Header is fixed at 8 bytes (64-bits) positioned contiguously in the sequence shown in Figure 10-31.

<b>msb</b>												<b>lsb</b>
31				15	12	11						0
TIME (LSLW)												
TIME (MSLW)												

Figure 10-31. Discrete Event Intra-Packet Data Header.



10.6.6.2.1.1 Intra-Packet Time Stamp. This frame (8 bytes) indicates the time tag of the discrete event shown in Figure 10-32. First long word bits 31-0 and second long word bits 31-0 indicate the following values:

- The Relative Time Counter that corresponds to the first data bit of the discrete event with bits 31 to 16 in the second long word zero filled; or
- Time, if enabled by bit 7 in the Packet Header Flags (paragraph 10.6.1.1.7), corresponds to the time format indicated by bits 2 and 3 in the Packet Secondary Header Time format (paragraph 10.6.1.1.7) and to the first data bit of the discrete event.

msb 15	lsb 0
PACKET HEADER	
CHANNEL SPECIFIC DATA (BITS 15-0)	
CHANNEL SPECIFIC DATA (BITS 31-16)	
INTRA-PACKET TIME STAMP FOR EVENT 1 (BITS 15-0)	
INTRA-PACKET TIME STAMP FOR EVENT 1 (BITS 31-16)	
INTRA-PACKET TIME STAMP FOR EVENT 1 (BITS 47-32)	
INTRA-PACKET TIME STAMP FOR EVENT 1 (BITS 63-48)	
STATES FOR EVENT 1 (BITS 15-0)	
STATES FOR EVENT 1 (BITS 31-16)	
:	
INTRA-PACKET TIME STAMP FOR EVENT n (BITS 15-0)	
INTRA-PACKET TIME STAMP FOR EVENT n (BITS 31-16)	
INTRA-PACKET TIME STAMP FOR EVENT n (BITS 47-32)	
INTRA-PACKET TIME STAMP FOR EVENT n (BITS 63-48)	
STATES FOR EVENT n (BITS 15-0)	
STATES FOR EVENT n (BITS 31-16)	
PACKET TRAILER	

Figure 10-32. Discrete Data – Packet format.

10.6.7 Computer Generated Data Packets. Packets with Computer Generated data (Meta, ASCII) have the basic structure shown in Figure 10-33. Formats 0 and 1 are used to add information packets to recorded data. This information contains annotation data and setup information for the data that is recorded. Note that the width of the structure is not related to any number of bits. This figure merely represents the relative placement of data in the packet.

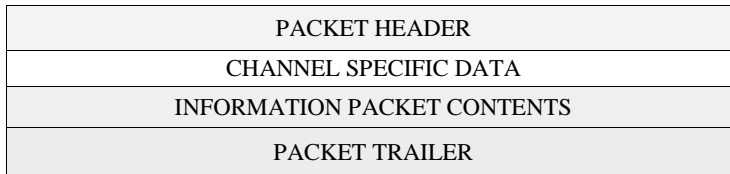

Figure 10-33. General Computer Generated Data Packet format.

10.6.7.1 Computer Generated Packet Channel Specific Data Word. The Packet Body portion of each Computer Generated Data Packet begins with the channel Specific Data word, which is formatted as shown in Figure [10-34](#).



Figure 10-34. Computer Generated Data Packet - Channel Specific Data word format.

10.6.7.2 Computer Generated Packet Data. After the Channel Specific Data, the Computer Generated Data is inserted in the packet. The organization and content of the Computer Generated Data is determined by the specific format type. There are no Intra-Packet Headers with Computer Generated Data Packets.

10.6.7.2.1 Format 0 – User Defined Data. Format 0 enables the insertion of user-defined, Computer Generated Data (Meta, ASCII).

10.6.7.2.2 Format 1 – Setup Records. Format 1 defines a setup record that describes the hardware, software, and data channel configuration used to produce the other data packets in the file. The organization and content of a Format 1 Setup Record is IAW with IRIG 106 Chapter 9 TMATS standard. It is mandatory for a TMATS record to be utilized to configure the solid-state recorder. A Format 1 Computer Generated Data Packet containing the TMATS record utilized to configure the recorder shall be the first packet in each data file.

10.6.8 ARINC-429 Data Packets, Format 0. Data shall be packetized in Word Mode: each 32-bit word of an ARINC-429 bus shall be preceded by an Intra-Packet Header containing an Intra-Packet Data Header only with an identifier (ID WORD) that provides type and status information. The Intra-Packet Header does not contain an Intra-Packet Time Stamp. The packet time in the packet header is the time of the first ARINC data word in the packet, and the time of successive ARINC data words is determined from the first word time using the gap times in the ID words that precede each of the data words. Multiple words of multiple ARINC-429 buses can be inserted into a single packet. The resultant packets shall have the format indicated in Figure [10-35](#).

msb	lsb
15	0
PACKET HEADER	
CHANNEL SPECIFIC DATA (BITS 15-0)	
CHANNEL SPECIFIC DATA (BITS 31-16)	
ID WORD FOR DATA WORD 1	
ID WORD FOR DATA WORD 1	
ARINC-429 DATA WORD 1 (BITS 15-0)	
ARINC-429 DATA WORD 1 (BITS 31-16)	
ID WORD FOR DATA WORD 2	
ID WORD FOR DATA WORD 2	
ARINC-429 DATA WORD 2 (BITS 15-0)	
ARINC-429 DATA WORD 2 (BITS 31-16)	
:	
ID WORD FOR DATA WORD n	
ID WORD FOR DATA WORD n	
ARINC-429 DATA WORD n (BITS 15-0)	
ARINC-429 DATA WORD n (BITS 31-16)	
PACKET TRAILER	

Figure 10-35. ARINC-429 Data Packet format.

 <p><b>NOTE</b></p>	<p>Time tagging of ARINC-429 shall correspond to the first data bit of the packet.</p>
--	--

10.6.8.1 ARINC-429 Packet Channel Specific Data Word. The Packet Body portion of each ARINC-429 data packet shall begin with a Channel Specific Data word formatted as shown in Figure [10-36](#).

msb	lsb
31	0
RESERVED	MSGCOUNT

Figure 10-36. ARINC 429 Packet Channel Specific Data Word format.

where:

Bits 15-0: Message count (MSGCOUNT): indicates the binary value of the number of ARINC-429 words included in the packet.

Bits 31-16: Reserved.

10.6.8.2 Intra-Packet Data Header. Bits 31-0 contain the ARINC-429 ID WORD. Each ARINC-429 bus data word is preceded by an identification word and the bit definitions are as shown in Figure 10-37.

<b>msb</b>								<b>lsb</b>
31	24	23	22	21	20	19		0
SUBCHANNEL-1		FE	PE	BS	RS	GAP TIME		

Figure 10-37. ARINC 429 ID Word bit definitions.

where:

- Bits 19-0: Gap Time: contains a binary value that represents the gap time from the beginning of the preceding bus word to the beginning of this bus word in 0.1 microsecond increments. The gap time of the first word in the packet is GAP TIME = 0. Before total time for packet data reaches 100 milliseconds, a new packet must be started.
- Bit 20: Reserved.
- Bit 21: ARINC-429 Bus (BS) indicates which ARINC-429 bus the data is from.  
0 = Indicates Low-Speed ARINC-429 bus (12.5 kHz).  
1 = Indicates High-Speed ARINC-429 bus (100 kHz).
- Bit 22: Parity Error (PE) indicates an ARINC-429 parity error.  
0 = No parity error has occurred.  
1 = Parity error has occurred.
- Bit 23: Format Error (FE) indicates an ARINC-429 format error.  
0 = No Format Error Has Occurred.  
1 = Format Error Has Occurred.
- Bits 31-24: Subchannel indicates a binary value that defines the ARINC-429 channel number belonging to the following data word. '0' means first channel. Maximum 256 ARINC-429 words can be placed in one packet.

10.6.8.3 ARINC-429 Packet Data Words. ARINC-429 data words shall be inserted into the packet in the original 32-bit format as acquired from the bus.

10.6.9 Message Data Packets, Format 0. The data from one or more separate serial communication interface channels can be placed into a message data packet as shown in Figure 10-38.

<b>msb</b>	<b>lsb</b>
15	0
PACKET HEADER	
CHANNEL SPECIFIC DATA (BITS 15-0)	
CHANNEL SPECIFIC DATA (BITS 31-16)	
INTRA-PACKET TIME STAMP FOR MSG 1 (BITS 15-0)	
INTRA-PACKET TIME STAMP FOR MSG 1 (BITS 31-16)	
INTRA-PACKET TIME STAMP FOR MSG 1 (BITS 47-32)	
INTRA-PACKET TIME STAMP FOR MSG 1 (BITS 63-48)	
INTRA-PACKET DATA HEADER FOR MSG 1 (BITS 15-0)	
INTRA-PACKET DATA HEADER FOR MSG 1 (BITS 31-16)	
BYTE 2	BYTE 1
:	:
FILLER (IF n IS ODD)	BYTE n
:	
INTRA-PACKET TIME STAMP FOR MSG n (BITS 15-0)	
INTRA-PACKET TIME STAMP FOR MSG n (BITS 31--16)	
INTRA-PACKET TIME STAMP FOR MSG n (BITS 47-32)	
INTRA-PACKET TIME STAMP FOR MSG n (BITS 63-48)	
INTRA-PACKET DATA HEADER FOR MSG n (BITS 15-0)	
INTRA-PACKET DATA HEADER FOR MSG n (BITS 31-16)	
BYTE 2	BYTE 1
:	:
FILLER (IF n IS ODD)	BYTE n
PACKET TRAILER	

Figure 10-38. Message Data Packet format.

10.6.9.1 Message Packet Channel Specific Data Word. The packet body portion of each Message Data Packet begins with a Channel Specific Data word. It defines if the Packet Body contains several short messages (type: *complete*) or one segment of a long message (type: *segmented*).

10.6.9.1.1 Complete Message Channel Specific Data Word. The Channel Specific Data word is formatted for the Complete type of packet body as shown in Figure [10-39](#).

<b>msb</b>	<b>lsb</b>
31	0
18 17 16 15	
RESERVED	TYPE COUNTER

Figure 10-39. Complete Message Channel Specific Data Word Format.

where:

Bits 15-0: **Counter:** contains a binary value that represents the number of messages included in the packet.

Bits 17-16: **Type:** indicates the type of Serial Packet.

00 = One or more complete messages.

01 = Reserved.

10 = Reserved.

11 = Reserved.

Bits 31-18: **Reserved.**

10.6.9.1.2 **Segmented Message Channel Specific Data Word.** The Channel Specific Data word is formatted for the Segmented type of packet body as shown in Figure 10-40.

<b>msb</b>						<b>lsb</b>
31		18	17	16	15	0
RESERVED			TYPE		COUNTER	

Figure 10-40. Segmented type of Packet Body Channel Specific Data Word format.

where:

Bits 15-0: **Counter:** contains a binary value that represents the segment number of a long message. The number must start with 1, and must be incremented by one after each packet. The maximum length of a single long message can be 4 Gbytes (combined with the 16-bit Message Length field, see [paragraph 10.6.9.2.2](#)) number of messages included in the packet.

Bits 17-16: **Type:** indicates the type of Serial Packet.

00 = Reserved.

01 = Packet is a beginning of a long message from a single source.

10 = Whole packet is the last part of a long message from a single source.

11 = Whole packet is a middle part of a long message from a single source.

Bits 31-18 **Reserved.**

10.6.9.2. Message Data Intra-Packet Header. After the Channel Specific Data, Message Data is inserted into the packet. Each Message is preceded by an Intra-Packet Header that has both an Intra-Packet Time Stamp and an Intra-Packet Data Header containing a Message ID Word. The length of the Intra-Packet Header is fixed at 12 bytes (96-bits) positioned contiguously in the sequence shown in Figure [10-41](#).

<b>msb</b>	<b>lsb</b>
31	0
15	
TIME (LSLW)	
TIME (MSLW)	
MESSAGE ID WORD	

Figure 10-41. Message Data Intra-Packet Header.

10.6.9.2.1 Intra-Packet Time Stamp. This frame (8 bytes) indicates the time tag of the Message Data. First long word bits 31-0 and second long word bits 31-0 indicate the following values:

- The Relative Time Counter that corresponds to the first data bit in the message with bits 31 to 16 in the second long word zero filled; or
- Time, if enabled by bit 7 in the Packet Header Flags (paragraph 10.6.1.1.7), corresponds to the time format indicated by bits 2 and 3 in the Packet Secondary Header Time format (paragraph [10.6.1.1.7](#)) and to the first data bit in the Message.

10.6.9.2.2 Intra-Packet Data Header. The Intra-Packet Data Header is an identification word (Message ID Word) that precedes the message and is inserted into the packet with the format shown in Figure [10-42](#).

<b>msb</b>		<b>lsb</b>	
31	30	16	15
29		0	
DE	FE	SUBCHANNEL - 1	MESSAGE LENGTH

Figure 10-42. Intra-Packet Data Header format.

where:

- Bits 15-0: Message Length: contains a binary value that represents the length of the message in bytes (n) that follows the ID Word. The maximum length of a message (complete) or a message segment (segmented) is 64K bytes.
- Bits 29-16: Subchannel: contains a binary value that represents the subchannel number belonging to the message that follows the ID Word when the Channel ID in

the packet header defines a group of subchannels. Zero means first and/or only sub-channel.

Bit 30: Format Error (FE): used to indicate a protocol error, such as out-of-sequence data or length errors.

0 = No Format Error.  
1 = Format Error encountered.

Bit 31: Data Error (DE): used to indicate bad data bits as determined by parity, checksums, or CRC words received with the data.

0 = No Data Error has occurred.  
1 = Data Error has occurred.

10.6.10 Video Packets, Format 0 (MPEG-2). Format 0 Video Packets uses the industry standard MPEG-2 Main Profile @ Main Level (MP@ML) and Transport Stream Frames (TSF) per ISO/IEC 13818-1:2000 (see Table 10-6). These two MPEG algorithm features are combined to produce an encoded video stream, which can be encapsulated using conventional IRIG-106 Chapter 4 PCM techniques. This encapsulation method will be specified in this section as it pertains to Format 0 Mpeg-2 Video Packets.

By utilizing MP@ML, which is currently the most common combination of MPEG-2 profiles and levels, it is possible to code an ITU-R 601 recorder picture format without filtering processes before coding. This will eliminate the need for proprietary encoding/decoding (CODEC) filters which would violate the intent of an “open” standard and make decoding of the data difficult without specific knowledge of or access to the encoding process.

TABLE 10-6. MP@ML ALGORITHMS			
Profile Table		Level Table	
B-frames	YES	Maximum Bit Rate	15 Mbps
Chroma_format	4:2:0	Buffer Size	1835008 bits
Scalability	NONE	Maximum Sample Density	720 samples/lines 576 lines/frame 30 frames/s
Intra DC precision	8, 9, 10 bits	Luminance Sample Rate	10368000
		Horizontal Vector Range	-512:+511.5
		Vertical Vector Range (frame pictures)	-128:+127.5



A packet with Format 0 MPEG-2 Video data has the basic structure shown in Figure 10-43. Note that the width of the structure is not related to any number of bits. This figure merely represents the relative placement of data in the packet.

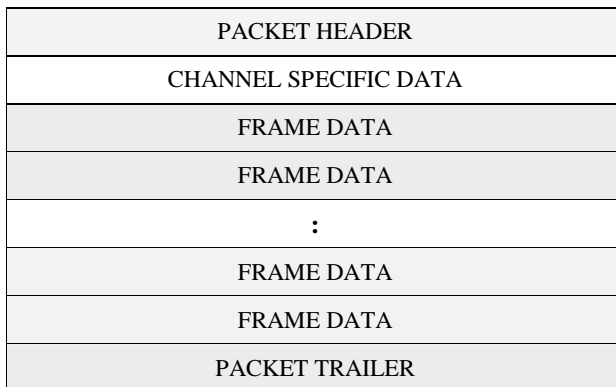

Figure 10-43. General MPEG-2 Video Packet, Format 0.

10.6.10.1 Video Packet Audio. When recording video using Format 0 MPEG-2 Video, and audio is also required data, audio will be inserted into the TSF per ISO/IEC 13818-3. A separate analog channel to specifically record audio is not required as MPEG-2 supports audio insertion into the TSF. By combining video and audio recording, bandwidth and memory capacity will be increased.

10.6.10.2 Video Packet Channel Specific Data Word. The packet body portion of each format 0 MPEG-2 video packet begins with the Channel Specific Data word, which is formatted as shown in Figure 10-44.

<b>msb</b>							<b>lsb</b>		
31	30	29	28	27	24	23	18	17	0
R	R	MA	MI	LOCKST	MODE	RESERVED			

Figure 10-44. Video Packet Channel Specific Data Word format.

where:

Bits 17-0: Reserved.

Bits 23-18: Mode: indicates the Data Packing Mode (ref [10.6.2.2.1](#) and [10.6.2.2.2](#))

Bits 23-20 are reserved.

Bit 19 indicates Packed Data Mode.

- 0 = Packed Data Mode not enabled.
- 1 = Packed Data Mode enabled.

Bit 18 is reserved.

Bits 27-24: Lock Status (LOCKST): indicates the lock status of the frame synchronizer.

Bits 27-26 indicate Minor Frame Status.

- 00 = Reserved.
- 01 = Reserved.
- 10 = Minor Frame Check (after losing Lock).
- 11 = Minor Frame Lock.

Bits 25-24 indicate Major Frame Status.

- 00 = Minor Frames only.
- 01 = Reserved.
- 10 = Major Frame Check (after losing Lock).
- 11 = Major Frame Lock.

Bit 28: Minor Frame Indicator (MI): indicates if the first word in the packet is the beginning of a TSF.

- 0 = First word is not the beginning of a minor frame.
- 1 = First word is the beginning of a minor frame.

Bit 29: Major Frame Indicator (MA): indicates if the first word in the packet is the beginning of a major TSF.

- 0 = First word is not the beginning of a major frame.
- 1 = First word is the beginning of a major frame.

Bits 31-30: Reserved (R).

10.6.10.3 Video Packet Data. A Format 0 Video Packet shall contain an integral number of Transport Stream Frames (TSFs.) No Intra-Packet Headers are inserted in Format 0 Video Data Packets (Figure 10-46). The Packet Header time is the time of the first TSF in the packet. The bit rate of the encoding will be user selectable and within the MP@ML specification, but the frame format must be set up as follows for proper alignment of the TSF:

- a. 94 words per frame (includes sync)
- b. 16 bits per word
- c. 8 bit sync pattern, 01000111 (0x47)

A TSF is made up of fixed-length 188 byte frames containing an 8-bit sync pattern or “sync byte” (starting at bit 0 and ending at bit 7 of the TSF). The sync bytes value is 01000111 (0x47). The first bit (bit 0) of the first word in the PCM frame will be aligned on the first bit (bit 0) of the TSF sync byte. The rest of the TSF 187 data bytes will follow as shown in Fig. 10-45.

<b>msb</b> 15	<b>lsb</b> 0
TSF DATA BITS 15 TO 8	TSF SYNC BYTE BITS 7 TO 0
TSF DATA BITS 31 TO 16	
:	
TSF DATA BITS 1503 TO 1488	

Figure 10-45. Format 0 MPEG-2 Video Frame Sync and Word format.

<b>msb</b> 15	<b>lsb</b> 0
PACKET HEADER	
CHANNEL SPECIFIC DATA (BITS 15-0)	
CHANNEL SPECIFIC DATA (BITS 31-16)	
TSF DATA BITS 15 TO 0	
TSF DATA BITS 31 TO 16	
:	
TSF DATA BITS 1487 TO 1472	
TSF DATA BITS 1503 TO 1488	
TSF DATA BITS 15 TO 0	
TSF DATA BITS 31 TO 16	
:	
TSF DATA BITS 1487 TO 1472	
TSF DATA BITS 1503 TO 1488	
:	
REPEAT FOR EACH TSF	
:	
PACKET TRAILER	

Figure 10-46. Format 0 MPEG-2 Video Data – sample packet.

10.6.11 Image Packets, Format 0. A Format 0 Image Packet shall contain one or more fixed-length segments of one or more video images (Figure 10-47). The Channel Specific Data word for an image packet identifies the number of segments in the packet and the portion of the image or images contained in the packet. If the optional Intra-Packet Header is not included with each segment, the Relative Time Counter in the packet header is the time of the first segment in the packet.

<b>msb</b> 15	<b>lsb</b> 0
PACKET HEADER	
CHANNEL SPECIFIC DATA (BITS 15-0)	
CHANNEL SPECIFIC DATA (BITS 31-16)	
OPTIONAL INTRA-PACKET HEADER FOR SEGMENT 1 (BITS 15-0)	
OPTIONAL INTRA-PACKET HEADER FOR SEGMENT 1 (BITS 31-16)	
OPTIONAL INTRA-PACKET HEADER FOR SEGMENT 1 (BITS 47-32)	
OPTIONAL INTRA-PACKET HEADER FOR SEGMENT 1 (BITS 63-48)	
BYTE 2	BYTE 1
:	:
FILLER (IF n IS ODD)	BYTE n
:	
OPTIONAL INTRA-PACKET HEADER FOR SEGMENT n (BITS 15-0)	
OPTIONAL INTRA-PACKET HEADER FOR SEGMENT n (BITS 31-16)	
OPTIONAL INTRA-PACKET HEADER FOR SEGMENT n (BITS 47-32)	
OPTIONAL INTRA-PACKET HEADER FOR SEGMENT n (BITS 63-48)	
BYTE 2	BYTE 1
:	:
FILLER (IF n IS ODD)	BYTE n
PACKET TRAILER	

Figure 10-47. Image Packet, Format 0.

10.6.11.1 Image Packet Channel Specific Data Word. The Packet Body portion of each Image Packet begins with a Channel Specific Data word. It defines the byte length of each segment and indicates if the Packet Body contains several complete images or partial images, and whether or not the Intra-Packet Data Header precedes each segment (Figure 10-48).

<b>msb</b> 31	30	29	28	27	26	<b>lsb</b> 0
PARTS	SUM	IPH	LENGTH			

Figure 10-48. Image Packet Channel Specific Data Word format.

where:

- Bits 26-0: **Length**: indicates a binary value that represents the byte length of each segment.
- Bit 27: **Intra-Packet Header (IPH)**: indicates that the Intra-Packet Header (Time Stamp) precedes each segment of the image.
  - 0 = Intra-Packet Header not enabled.
  - 1 = Intra-Packet Header enabled.
- Bits 29-28: **Sum**: indicates if the packet contains a partial image, one complete image, multiple complete images, or pieces from multiple images.
  - 00 = Packet contains less than one complete image.
  - 01 = Packet contains one complete image.
  - 10 = Packet contains multiple complete images.
  - 11 = Packet contains multiple incomplete images.
- Bits 31-30: **Parts**: indicates which piece or pieces of the video frame are contained in the packet.
  - 00 = Packet does not contains first or last segment of image.
  - 01 = Packet contains first segment of image.
  - 10 = Packet contains last segment of image.
  - 11 = Packet contains both first and last segment of image.

10.6.11.2 **Image Intra-Packet Header**. After the Channel Specific Data, Format 1 Image Data is inserted into the packet. Each block of data is optionally preceded by an Intra-Packet Header as indicated by the IPH bit in the Channel Specific Data word. When included, the Intra-Packet Header consists of an Intra-Packet Time Stamp only. The length of the Intra-Packet Header is fixed at 8 bytes (64-bits) positioned contiguously in the sequence shown in Figure 10-49.

<b>msb</b>	<b>lsb</b>
31	0
15	
TIME (LSLW)	
TIME (MSLW)	

Figure 10-49. Format 1 Image Data Intra-Packet Data Header.

10.6.11.2.1 **Intra-Packet Time Stamp**. This frame (8 bytes) indicates the time tag of the Format 0 Image Data. First long word bits 31-0 and Second long word bits 31-0 indicate the following values:

- The Relative Time Counter that corresponds to the first data bit in the first byte with bits 31 to 16 in the second long word zero filled; or

- Packet Secondary Header Time Type, if enabled by bit 7 in the Packet Header Flags (paragraph 10.6.1.1.7), corresponds to the time format indicated by bits 2 and 3 in the Packet Secondary Header Time (paragraph 10.6.1.1.7) and to the first data bit in the Message.

10.6.12 UART Data Packets, Format 0. The data from one or more separate asynchronous serial communication interface channels (RS-232, RS-422, RS-485, etc.) can be placed into a UART Data Packet as shown in Figure 10-50.

<b>msb</b> 15	<b>lsb</b> 0
PACKET HEADER	
CHANNEL SPECIFIC DATA (BITS 15-0)	
CHANNEL SPECIFIC DATA (BITS 31-16)	
(OPTIONAL) INTRA-PACKET DATA HEADER FOR UART 1 (BITS 15-0)	
(OPTIONAL) INTRA-PACKET DATA HEADER FOR UART 1 (BITS 31-16)	
(OPTIONAL) INTRA-PACKET DATA HEADER FOR UART 1 (BITS 47-32)	
(OPTIONAL) INTRA-PACKET DATA HEADER FOR UART 1 (BITS 63-48)	
UART ID for UART 1 (BITS 15-0)	
UART ID for UART 1 (BITS 31-16)	
BYTE 2	BYTE 1
:	:
FILLER (IF n IS ODD)	BYTE n
:	
(OPTIONAL) INTRA-PACKET DATA HEADER FOR UART n (BITS 15-0)	
(OPTIONAL) INTRA-PACKET DATA HEADER FOR UART n (BITS 31-16)	
(OPTIONAL) INTRA-PACKET DATA HEADER FOR UART n (BITS 47-32)	
(OPTIONAL) INTRA-PACKET DATA HEADER FOR UART n (BITS 63-48)	
UART ID for UART n (BITS 15-0)	
UART ID for UART n (BITS 31-16)	
BYTE 2	BYTE 1
:	:
FILLER (IF n IS ODD)	BYTE n
PACKET TRAILER	

Figure 10-50. UART Data Packet Format 0.

10.6.12.1 UART Packet Channel Specific Data Word, Format 0. The Packet Body portion of each UART Data Packet begins with a Channel Specific Data word as shown in Figure 10-51.

msb		lsb
31	30	0
IPH	RESERVED	

Figure 10-51. UART Packet Channel Specific Data Word, Format 0.

where:

Bits 30-0: Reserved.

Bit 31: Intra-Packet Header (IPH): indicates that the Intra-Packet Header is inserted before the UART ID Words.

0 = Intra-Packet Header not enabled.

1 = Intra-Packet Header enabled.

10.6.12.2 UART Intra-Packet Header, Format 0. After the Channel Specific Data, UART Data is inserted into the packet. Each block of data is preceded by an Intra-Packet Header consisting of the Intra-Packet Time Stamp and a UART ID Word Intra-Packet Data Header. The length of the Intra-Packet Header is fixed at 8 bytes (64-bits) positioned contiguously in the sequence shown in Figure [10-52](#).

<b>msb</b>		<b>lsb</b>
31	15	0
TIME (LSLW)		
TIME (MSLW)		
UART ID WORD		

Figure 10-52. UART Data Intra-Packet Data Header.

10.6.12.2.1 Intra-Packet Time Stamp. This frame (8 bytes) indicates the time tag of the Format 1 Image Data. First long word bits 31-0 and second long word bits 31-0 indicate the following values:

- The Relative Time Counter that corresponds to the first data bit in the first byte with bits 31 to 16 in the second long word zero filled; or
- Packet Secondary Header Time Type, if enabled by bit 7 in the Packet Header Flags (paragraph 10.6.1.1.7), corresponds to the time format indicated by bits 2 and 3 in the Packet Secondary Header Time (paragraph [10.6.1.1.7](#)) and to the first data bit in the Message.

10.6.12.2.2 Intra-Packet Data Header. The Intra-Packet Data Header is an identification word (UART ID Word) that precedes the data and is inserted into the packet with the format indicated in Figure 10-53.

<b>msb</b>										<b>lsb</b>
31	30		29			16	15			0
PE	RESERVED		SUBCHANNEL - 1			DATA LENGTH				

Figure 10-53. UART Data ID Word format.

where:

- Bits 15-0: Data Length: indicates a binary value that represents the length of the UART data in bytes (n) that follow the UART ID Word.
- Bits 29-16: Subchannel: indicates a binary value that defines the subchannel number belonging to the data that follows the UART ID Word when the Channel ID in the packet header defines a group of subchannels. Zero means first and/or only sub-channel that the Intra-Packet Data Header is inserted before the UART ID Words.
- Bit 30: Reserved.
- Bit 31: Parity Error (PE): indicates a Parity Error.  
 0 = No Parity Error  
 1 = Parity Error

## 10.7 Solid State Recorder Control and Status

10.7.1 Recorder Control. The recorder may be controlled by either discrete control/status lines and/or serial communication ports. The serial interface shall consist of both RS-232 and RS-422 full duplex serial communications.

10.7.2 Communication Ports. The RS-232 and RS-422 serial communication ports shall be functional simultaneously without requiring selection of either port. Status requested by either port shall be returned on both ports. Note that unexpected results may occur if commands are issued on both ports simultaneously.

10.7.3 RS-232 Port. An RS-232 port shall be available at the Download Port.

10.7.4 Commands. Commands received through the serial communication ports shall not override hardware discrete controls.



10.7.5 Status Requests. Status requests received through the serial communication ports shall not interfere with hardware controls.

10.7.6 Serial Status. Serial status shall be provided on either serial status request or discrete activation.

10.7.7 Default Interface. Default Interface with user equipment shall utilize the following ASCII serial communication protocol:

- 38400 baud
- One start bit
- 8 bit data
- No parity
- One stop bit

10.7.8 Serial Commands. The following SSR commands are a subset of the Recorder Command and Control Mnemonics defined in IRIG Standard 106, Chapter 6, section 18, where additional rules regarding command syntax and recorder operation are also specified, along with examples showing the use of each command. The SSR commands are simple ASCII command strings delimited by spaces. All commands begin with an ASCII period (“.”) and, with the single exception of the .TMATS command, end with a carriage return and line-feed terminator sequence. Table 6-15 in Chapter 6 summarizes the required commands.

10.7.9 Required Discrete Control Functions. Required discrete control functions are noted in Figure 10-54.

Description
RECORD
ERASE
DECLASSIFY
ENABLE
BIT

Figure 10-54. Required Discrete Control Functions.

10.7.9.1 Control and Status Lines. In addition to the five contacts for discrete control, five lines for indicating status shall be provided. Grounding a control line (or causing the indicator line to go to ground) referenced to the recorder’s ground completes the circuit to activate a function (Figure 10-55).

10.7.9.1.1 RECORD Command. Activated by toggle switch (normally closed position .55 volts or less), this discrete commands the recorder to start recording. Recorder will remain in this mode until such time as the switch is set to normally open position.

10.7.9.1.2 ERASE Command. Activated by momentary switch (.55 volts or less, minimum duration of 100 ms), this discrete commands the recorder to erase its user data and file directory memory provided the enable switch is also activated.

10.7.9.1.3 DECLASSIFY Command. Activated by momentary switch (.55 volts or less, minimum duration of 100 ms), this discrete causes the recorder to start the declassify procedure provided the enable switch is also activated.

10.7.9.1.4 Command ENABLE. Activated by momentary switch (.55 volts or less) for either ERASE or DECLASSIFY discrete to operate.

10.7.9.1.5 BIT Command. Activated by momentary switch (.55 volts or less), this discrete commands the recorder to start the BIT procedure.

10.7.9.1.6 Record Status. A “record” indication (ON) shall be active at .55 volts or less. A “non-record” indication (OFF) will be an open circuit. Current limit of 60 milliamps required.

10.7.9.1.7 BIT Status. A “BIT” indication (ON) shall be .55 volts or less. A “non-BIT” indication (OFF) will be an open circuit. Current limit of 60 milliamps required.

10.7.9.1.8 Fault Status. A “fault” indication (ON) shall be .55 volts or less. A “non-fault” indication (OFF) will be an open circuit. Current limit of 60 milliamps required.

10.7.9.1.9 Erase Status. An “erase” indication (ON) shall be .55 volts or less. A “non-erase” indication (OFF) will be an open circuit. Current limit of 60 milliamps required.

10.7.9.1.10 Declassify Status. A “declassify” indication (ON) shall be .55 volts or less. A “non-declassify” indication (OFF) will be an open circuit. No discrete control line shall be available at the download port. Current limit of 60 milliamps required.

10.7.10 Voltage. Auxiliary voltage output of 28 Vdc shall be provided from the discrete/control port (250 mA maximum, short circuit protection).

10.7.11 Status Querying. Status querying shall be limited to intervals not to exceed two seconds and not faster than one second.

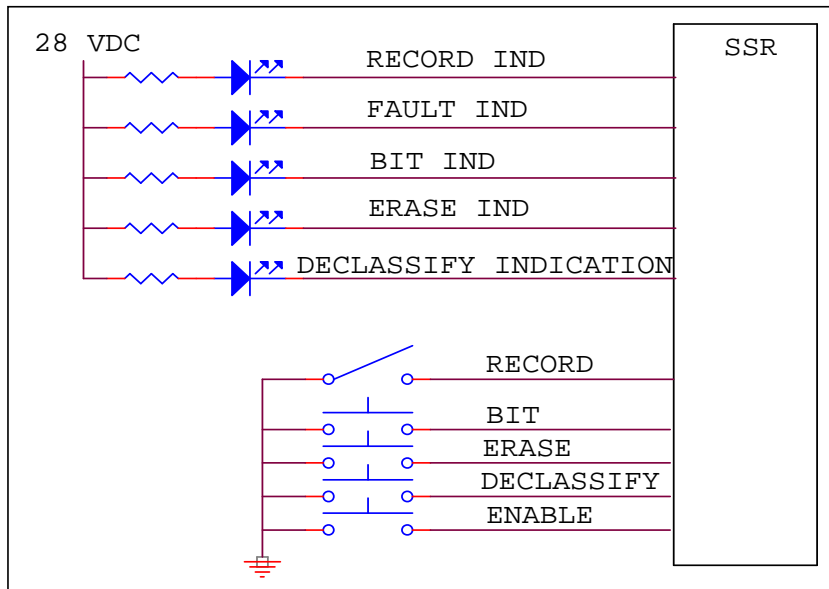

Figure 10-55. Discrete Control and Indicator functional diagram.

## 10.8 Declassification

10.8.1 Associated Documents. Documents such as NSA-130-2, DOD 5200.28 (1972) and DCI-116 historically covered declassification guidelines/requirements. These documents focused on declassification of standard disk and other conventional memory technologies. With the advent of advanced, high-density memory technologies, additional guidance must be provided. A new document that addresses various solid state, hard disk, floppy disk, RAID, and other storage media, declassification is being developed under NTISSP-9 working group for U.S. Policy.

10.8.2 Approach. The following approaches for declassification are currently recommended. The risk that proper declassification has been effectively implemented will reside ultimately with the user/customer/program manager. It is believed that the user is the most qualified to determine the declassification procedures for any program situation. It is their responsibility to correctly apply the guidelines to the program in each location to optimize the cost/effect while providing appropriate protection for the data. The guidelines are planned to be available on the Internet at Defense Link.

10.8.3 Algorithm. The algorithm to erase secure data is described in the sections below. During the Secure Erase procedure, all blocks of memory shall be processed. No block in memory shall be excluded from Secure Erase processing for any reason.

10.8.3.1 First Erase. Every memory block on the board is erased. Any erase failures reported by memory chips will result in the corresponding chip/block being declared a bad block. In the event this bad block is not already in the corresponding board's bad block table, a new bad block

entry will be appended onto the board's bad block table. Note that this new entry will not have the Secure Erase flag set.

10.8.3.2 First Write (0x55). Every memory chip location is recorded with the pattern 0x55. As each location is written, the data is read back to guarantee that all bits were written to the expected pattern. Any write failures reported by the chips, or any data errors will result in the corresponding chip/block being declared a bad block. In the event this bad block is not already in the corresponding board's bad block table, a new bad block entry will be appended onto the board's bad block table. Note that this new entry will not have the Secure Erase flag set.

10.8.3.3 Second Erase. Every memory chip shall be erased. Any erase failures reported by the memory chips will result in the corresponding chip/block being declared a bad block. In the event this bad block is not already in the corresponding board's bad block table, a new bad block entry will be appended onto the board's bad block table. Note that this new entry will not have the Secure Erase flag set.

10.8.3.4 Second Write (0xAA). Every memory chip location is recorded with the pattern 0xAA. As each location is written, the data is read back to guarantee that all bits were written to the expected pattern. Any write failures reported by the memory chips, or any data errors will result in the corresponding chip/block being declared a bad block. In the event this bad block is not already in the corresponding board's bad block table, a new bad block entry will be appended onto the board's bad block table. Note that this new entry will not have the Secure Erase flag set.

10.8.3.5 Third Erase. Every memory location is erased. Any erase failures reported by the memory chips will result in the corresponding chip/block being declared a bad block. In the event this bad block is not already in the corresponding board's bad block table, a new bad block entry will be appended onto the board's bad block table. Note that this new entry will not have the Secure Erase flag set.

10.8.3.6 Usable Secure Erased Blocks. All blocks that do not have an entry in the bad block table are now considered to be Secure Erased.

10.8.3.7 Unusable Secure Erased Blocks. If a bad block entry contains the flag indicating it has already been secure erased, this block has already been Secure Erased and requires no further processing, since it is known that this block was skipped during the previous recording.

10.8.3.8 Unsecure Bad Block Processing. A board's bad block table may contain bad block entries that have not previously been Secure Erased. If any such entries exist, the following steps are performed on each block.

10.8.3.8.1 Write Zeros Loop. For each page in the block, a pattern of all zeros is written to the page, and the page is checked to determine if any unexpected ones (UOs) are found. If any UOs are found, the page is re-written to all zeros. This process is repeated up to 16 times. After all allowed re-writes, the board, chip, and block numbers of the block containing any remaining UOs are written to a "Failed Erase Table".

10.8.3.8.2 Write Ones Loop. For each page in the block, the page is erased (to all ones) and checked to determine if any unexpected zeros (UZs) are found. If any UZs are found, another erase command is issued to the block. This process is repeated up to 16 times. After all allowed erase operations, the board, chip, and block numbers of the block containing any remaining UZs are written to the Failed Erase Table.

10.8.3.9 Failed Erase Table Processing. Any remaining entries in the Failed Erase Table correspond to blocks that cannot be erased. These blocks may still contain user data and, therefore, are declared to have failed the Secure Erase.

A count of the number of bad blocks in the Failed Erase Table that have not been Secure Erased is returned as part of the Secure Erase results. A non-zero count indicates a Secure Erase failure of at least one block. A command will allow the user to retrieve the Failed Erase Table. A command will also allow a user to retrieve the data from such blocks and manually determine if these blocks can be designated as "Secure Erased." In most cases a single stuck bit will not compromise any user data and the offending block can be manually declared to be Secure Erased. If the results of manual inspection are indeterminate, the chip containing the failed block must be removed and destroyed, and the Secure Erase procedure must be repeated.

10.8.3.10 Secure Erase Completion. When all blocks are secure erased (no entries in the Failed Erase Table), a single file is written that completely fills the memory. The content of the file is the ASCII string "Secure Erase" repeated over and over. The name of the file in the file table is "SecureErase."

This page intentionally left blank.



## APPENDIX A

# FREQUENCY CONSIDERATIONS FOR TELEMETRY

## 1.0 Purpose

This appendix was prepared with the cooperation and assistance of the Range Commanders Council (RCC) Frequency Management Group (FMG). This appendix provides guidance to telemetry users for the most effective use of the ultra high frequency (UHF) telemetry bands, 1435 to 1535 MHz, 2200 to 2290 MHz, and 2310 to 2390 MHz. Coordination with the frequency managers of the applicable test ranges and operating areas is recommended before a specific frequency band is selected for a given application. Government users should coordinate with the appropriate Area Frequency Coordinator and commercial users should coordinate with the Aerospace and Flight Test Radio Coordinating Council (AFTRCC). A list of the points of contact can be found in the National Telecommunications and Information Administration's (NTIA) Manual of Regulations and Procedures for Federal Radio Frequency Management. The manual is at <http://www.ntia.doc.gov/osmhome/redbook/redbook.html>.

## 2.0 Scope

This appendix is to be used as a guide by users of telemetry frequencies at Department of Defense (DoD)-related test ranges and contractor facilities. The goal of frequency management is to encourage maximal use and minimal interference among telemetry users and between telemetry users and other users of the electromagnetic spectrum.

2.1 Definitions. The following terminology is used in this appendix.

Allocation (of a Frequency Band). Entry of a frequency band into the Table of Frequency Allocations<sup>30</sup> for use by one or more radio communication services or the radio astronomy service under specified conditions.

Assignment (of a Radio Frequency or Radio Frequency Channel). Authorization given by an administration for a radio station to use a radio frequency or radio frequency channel under specified conditions.

Authorization. Permission to use a radio frequency or radio frequency channel under specified conditions.

---

<sup>30</sup> The definitions of the radio services that can be operated within certain frequency bands contained in the radio regulations as agreed to by the member nations of the International Telecommunications Union. This table is maintained in the United States by the Federal Communications Commission and the NTIA.

Certification. The Military Communications-Electronics Board's (MCEB) process of verifying that a proposed system complies with the appropriate rules, regulations, and technical standards.

J/F 12 Number. The identification number assigned to a system by the MCEB after the Application for Equipment Frequency Allocation (DD Form 1494) is approved; for example, J/F 12/6309 (sometimes called the J-12 number).

Resolution Bandwidth. The -3 dB bandwidth of the measurement device.

## 2.2 Modulation methods.

Deleted: 5

2.2.1 Traditional Modulation Methods. The traditional modulation methods for aeronautical telemetry are Frequency Modulation (FM) and Phase Modulation (PM). Pulse Code Modulation (PCM)/Frequency Modulation (FM) has been the most popular telemetry modulation since around 1970. The PCM/FM method could also be called filtered Continuous Phase Frequency Shift Keying (CPFSK). The RF signal is typically generated by filtering the baseband non-return-to-zero-level (NRZ-L) signal and then frequency modulating a voltage-controlled oscillator (VCO). The optimum peak deviation is 0.35 times the bit rate and a good choice for a premodulation filter is a multi-pole linear phase filter with bandwidth equal to 0.7 times the bit rate. Frequency and phase modulation have a variety of desirable features but may not provide the required bandwidth efficiency, especially for higher bit rates.

2.2.2 Improved Bandwidth Efficiency. When better bandwidth efficiency is required, the standard methods for digital signal transmission are the Feher Patented Quadrature Phase Shift Keying (FQPSK-B and FQPSK-JR), the Shaped Offset Quadrature Phase Shift Keying (SOQPSK-TG), and the Advanced Range Telemetry (ARTM) Continuous Phase Modulation (CPM). Each of these methods offers constant, or nearly constant, envelope characteristics and are compatible with non-linear amplifiers with minimal spectral regrowth and minimal degradation of detection efficiency. The first three methods (FQPSK-B, FQPSK-JR, and SOQPSK-TG) are interoperable and require the use of the differential encoder described in Chapter 2, paragraph 2.4.3.1.1. Additional information on this differential encoder is contained in Appendix M. All of these bandwidth-efficient modulation methods require the data to be randomized.

Deleted: 2.4.5

2.3 Other Notations. The following notations are used in this appendix. Other references may define these terms slightly differently.

- $B_{99\%}$  Bandwidth containing 99 percent of the total power
- $B_{-25dBm}$  Bandwidth containing all components larger than -25 dBm
- $B_{-60dBc}$  Bandwidth containing all components larger than the power level that is 60 dB below the unmodulated carrier power
- dBc Decibels relative to the power level of the unmodulated carrier
- $f_c$  Assigned center frequency



### 3.0 Authorization to Use a Telemetry System

All radio frequency (RF) emitting devices must have approval to operate in the United States and Possessions (US&P) via a frequency assignment unless granted an exemption by the national authority. The NTIA is the President's designated national authority and spectrum manager. The NTIA manages and controls the use of RF spectrum by federal agencies in US&P territory. Obtaining a frequency assignment involves the two-step process of obtaining an RF spectrum support certification of major RF systems design, followed by an operational frequency assignment to the RF system user. These steps are discussed below.

3.1 RF Spectrum Support Certification. All major RF systems used by federal agencies must be submitted to the NTIA, via the Interdepartmental Radio Advisory Committee (IRAC), for system review and spectrum support certification prior to committing funds for acquisition/procurement. During the system review process, compliance with applicable RF standards, and RF allocation tables, rules, and regulations is checked. For Department of Defense (DoD) agencies, and for support of DoD contracts, this is accomplished via the submission of a DD Form 1494 to the MCEB. Noncompliance with standards, the tables, rules, or regulations can result in denial of support, limited support, or support on an unprotected non-priority basis. All RF users must obtain frequency assignments for any RF system (even if not considered major). This assignment is accomplished by submission of frequency use proposals through the appropriate frequency management offices. Frequency assignments may not be granted for major systems that have not obtained spectrum support certification.

3.1.1 Frequency Allocation. As stated before, telemetry systems must normally operate within the frequency bands designated for their use in the National Table of Frequency Allocations. With sufficient justification, use of other bands may at times be permitted, but the certification process is much more difficult, and the outcome is uncertain. Even if certification is granted on a noninterference basis to other users, the frequency manager is often unable to grant assignments because of local users who will get interference.

3.1.1.1 Telemetry Bands. Air and space-to-ground telemetering is allocated in the UHF bands 1435 to 1535, 2200 to 2290, and 2310 to 2390 MHz, commonly known as the lower-L band, the lower-S band, and the upper-S band. Other mobile bands, such as 1755-1850 MHz, can also be used at many test ranges. Since these other bands are not considered a standard telemetry band per this document, potential users must coordinate, in advance, with the individual range(s) and ensure use of this band can be supported at the subject range(s) and that their technical requirements will be met.

3.1.1.2 Very High Frequency (VHF) Telemetry. The VHF band, 216-265 MHz, was used for telemetry operations in the past. Telemetry bands were moved to the UHF bands as of 1 January 1970 to prevent interference to critical government land mobile and military tactical communications. Telemetry operation in this band is strongly discouraged and is considered only on an exceptional case-by-case basis.

3.1.2 Technical Standards. The MCEB and the NTIA review proposed telemetry systems for compliance with applicable technical standards. For the UHF telemetry bands, the current revisions of the following standards are considered applicable:

- RCC Document IRIG 106, Telemetry Standards
- MIL-STD-461, Requirements for the Control of Electromagnetic Interference Emissions and Susceptibility
- Manual of Regulations and Procedures for Federal Radio Frequency Management (NTIA)

Applications for certification are also thoroughly checked in many other ways including necessary and occupied bandwidths, modulation characteristics, reasonableness of output power, correlation between output power and amplifier type, and antenna type and characteristics. The associated receiver normally must be specified or referenced. The characteristics of the receiver are also verified.

3.2 Frequency Authorization. Spectrum certification of a telemetry system verifies that the system meets the technical requirements for successful operation in the electromagnetic environment. However, a user is not permitted to radiate with the telemetry system before requesting and receiving a specific frequency assignment. The assignment process considers when, where, and how the user plans to radiate. Use of the assignments is tightly scheduled by and among the individual ranges to make the most efficient use of the limited telemetry radio frequency (RF) spectrum and to ensure that one user does not interfere with other users.

#### 4.0 Frequency Usage Guidance

Frequency usage is controlled by scheduling in the areas where the tests will be conducted. The following recommendations are based on good engineering practice for such usage and it is assumed that the occupied bandwidth fits within the telemetry band in all cases.

##### 4.1 Minimum Frequency Separation.

The minimum required frequency separation can be calculated using the formula:

$$\Delta F_0 = a_s \cdot R_s + a_i \cdot R_i \quad (A-1)$$

where:

$\Delta F_0$  = the minimum required center frequency separation in MHz

$R_s$  = bit rate of desired signal in Mb/s

$R_i$  = bit rate of interfering signal in Mb/s

$a_s$  is determined by the desired signal type and receiving equipment (Table A-1).

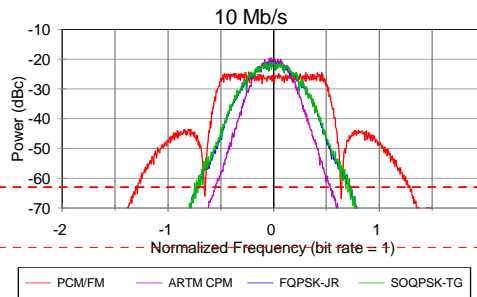

Figure A-1. Spectra of 10-Mb/s CPFSK, ARTM CPM, FQPSK-JR, SOQPSK-TG signals.

- Deleted: D
- Deleted: A
- Deleted: S
- Deleted: B
- Deleted: I
- Deleted: D
- Deleted: S
- Deleted: I
- Deleted: A

TABLE A-1. COEFFICIENTS FOR MINIMUM FREQUENCY SEPARATION CALCULATION		
Modulation Type	$a_s$	$a_i$
NRZ PCM/FM	1.0* for receivers with RLC final Intermediate Frequency (IF) filters	1.2
	0.7 for receivers with Surface Acoustic Wave (SAW) or digital IF filters	
	0.5 with multi-symbol detectors (or equivalent devices)	
FQPSK-B, FQPSK-JR, SOQPSK-TG	0.45	0.65
ARTM CPM	0.35	0.5

\*The minimum frequency separation for typical receivers with Resistor-Inductor-Capacitor (RLC) final IF filters and NRZ-L PCM/FM signals is the larger of 1.5 times the actual IF -3 dB bandwidth and the value calculated using the equation above.

The minimum spacing needs to be calculated for signal 1 as the desired signal and signal 2 as the interferer and vice versa. Note that the values for  $a_i$  match the -57 dBc points for the four modulation methods shown in Figure A-1 quite closely. It is not surprising that the required frequency spacing from the interferer is directly related to the power spectrum of the interfering signal. The values for  $a_s$  are a function of the effective detection filter bandwidths and the co-channel interference resistance of the desired signal modulation method and detector. The values for  $a_s$  and  $a_i$  are slightly conservative for most cases and assume the receiver being used does not have spurious responses that cause additional interference. This section was completely rewritten from previous editions of the Telemetry Standards because addition of new modulation methods and new receiving equipment rendered the old method obsolete. The values of  $a_s$  and  $a_i$  were determined empirically from the results of extensive adjacent channel interference testing. The main assumptions are as follows:

- The NRZ PCM/FM signals are assumed to be premodulation filtered with a multi-pole filter with -3 dB point of 0.7 times the bit rate and the peak deviation is assumed to be approximately 0.35 times the bit rate.
- The receiver IF filter is assumed to be no wider than 1.5 times the bit rate and provides at least 6 dB of attenuation of the interfering signal.
- The interfering signal is assumed to be no more than 20 dB stronger than the desired signal.
- The receiver is assumed to be operating in linear mode; no significant intermodulation products or spurious responses are present.

Examples are shown below:

5 Mb/s PCM/FM and 0.8 Mb/s PCM/FM using a receiver with 6 MHz IF bandwidth for the 5 Mb/s signal (this receiver has RLC IF filters)

$1.0 * 5 + 1.2 * 0.8 = 5.96 \text{ MHz}$ ,  $1.0 * 8 + 1.2 * 5 = 6.8 \text{ MHz}$ ,  $1.5 * 6 = 9.0 \text{ MHz}$ ;  
 the largest value is 9 MHz and the frequencies are assigned in 1 MHz steps so the minimum spacing is 9 MHz

5 Mb/s PCM/FM and 5 Mb/s PCM/FM using a receiver with 6 MHz IF bandwidth for the 5 Mb/s signals (these receivers have RLC IF filters; see Figure A-2)

$1.0 * 5 + 1.2 * 5 = 11 \text{ MHz}$ ,  $1.5 * 6 = 9.0 \text{ MHz}$ ;  
 the larger value is 11 MHz and the frequencies are assigned in 1 MHz steps so the minimum spacing is 11 MHz

5 Mb/s PCM/FM and 5 Mb/s PCM/FM using a receiver with 6 MHz IF bandwidth for the 5 Mb/s signal (this receiver has RLC IF filters but a multi-symbol detector is used)

$0.5 * 5 + 1.2 * 5 = 8.5 \text{ MHz}$ ;  
 the frequencies are assigned in 1 MHz steps so the minimum spacing is 9 MHz

5 Mb/s PCM/FM and 5 Mb/s SOQPSK-TG using a receiver with 6 MHz IF bandwidth for the 5 Mb/s signals (this receiver has RLC IF filters but a multi-symbol detector is used)

$0.5 * 5 + 0.65 * 5 = 5.75 \text{ MHz}$ ,  $0.45 * 5 + 1.2 * 5 = 8.25 \text{ MHz}$ ;  
 the largest value is 8.25 MHz and the frequencies are assigned in 1 MHz steps so the minimum spacing is 9 MHz

5 Mb/s FQPSK-B and 5 Mb/s ARTM CPM using a receiver with 6 MHz IF bandwidth for the 5 Mb/s signals

$0.45 * 5 + 0.5 * 5 = 4.75 \text{ MHz}$   $0.35 * 5 + 0.7 * 5 = 5.25 \text{ MHz}$ ;  
 the largest value is 5.25 MHz and the frequencies are assigned in 1 MHz steps so the minimum spacing is 6 MHz

10 Mb/s ARTM CPM and 10 Mb/s ARTM CPM (see Figure A-3)

$0.35 * 10 + 0.5 * 10 = 8.5 \text{ MHz}$ ;  
 the frequencies are assigned in 1 MHz steps so the minimum spacing is 9 MHz

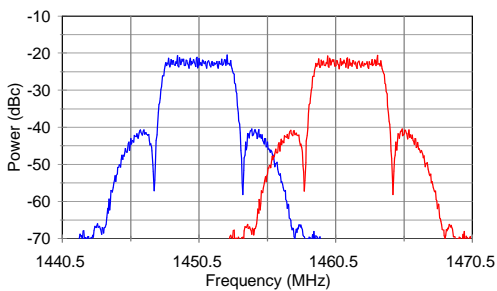

Figure A-2. 5 Mb/s PCM/FM signals with 11 MHz center frequency separation.

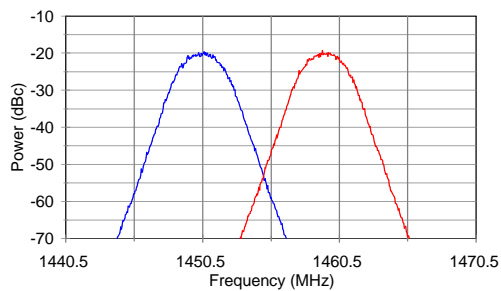

Figure A-3. 10 Mb/s ARTM CPM signals with 9 MHz center frequency separation

4.2 Alternative method for determining frequency separation. In some cases it may be desirable to set aside a bandwidth for each signal independent of other signals. If one uses a bandwidth factor of  $2 \cdot a_i$  for each signal, then one gets a separation of  $\Delta F_0 = a_i \cdot R_s + a_i \cdot R_i$  and one gets a more conservative (wider) separation than one would using  $\Delta F_0 = a_s \cdot R_s + a_i \cdot R_i$  because the value of  $a_i$  is bigger than the value of  $a_s$  for all of these modulation methods. One problem with this approach is that it does not include receiver or detector characteristics and therefore the calculated frequency separations are often different from those calculated using the formula in section 4.1.

- Deleted: B
- Formatted
- Deleted:  $DF = B_s \cdot S + B_i \cdot I$
- Deleted:  $DF = A \cdot S + B \cdot I$
- Deleted: B
- Deleted: A

Examples of frequency separation are shown below:

5 Mb/s PCM/FM and 0.8 Mb/s PCM/FM using a receiver with 6 MHz IF bandwidth for the 5 Mb/s signal (this receiver has RLC IF filters)

$$1.2 \cdot 5 + 1.2 \cdot 0.8 = 6.96 \text{ MHz};$$

the frequencies are assigned in 1 MHz steps so the minimum spacing is 7 MHz

5 Mb/s PCM/FM and 5 Mb/s PCM/FM using a receiver with 6 MHz IF bandwidth for the 5 Mb/s signals (these receivers have RLC IF filters)

$$1.2 \cdot 5 + 1.2 \cdot 5 = 12 \text{ MHz};$$

the frequencies are assigned in 1 MHz steps so the minimum spacing is 12 MHz

5 Mb/s PCM/FM and 5 Mb/s PCM/FM using a receiver with 6 MHz IF bandwidth for the 5 Mb/s signal (this receiver has RLC IF filters but a multi-symbol detector is used)

$$1.2 \cdot 5 + 1.2 \cdot 5 = 12 \text{ MHz};$$

the frequencies are assigned in 1 MHz steps so the minimum spacing is 12 MHz

5 Mb/s PCM/FM and 5 Mb/s SOQPSK-TG using a receiver with 6 MHz IF bandwidth for the 5 Mb/s signals (this receiver has RLC IF filters but a multi-symbol detector is used)

$$1.2 \cdot 5 + 0.65 \cdot 5 = 9.25 \text{ MHz};$$

the frequencies are assigned in 1 MHz steps so the minimum spacing is 10 MHz

5 Mb/s FQPSK-B and 5 Mb/s ARTM CPM using a receiver with 6 MHz IF bandwidth for the 5 Mb/s signals

$$0.7 \cdot 5 + 0.5 \cdot 5 = 6 \text{ MHz};$$

the frequencies are assigned in 1 MHz steps so the minimum spacing is 6 MHz

10 Mb/s ARTM CPM and 10 Mb/s ARTM CPM

$$0.5 \cdot 10 + 0.5 \cdot 10 = 10 \text{ MHz};$$

the frequencies are assigned in 1 MHz steps so the minimum spacing is 10 MHz

4.3 Geographical Separation. Geographical separation can be used to further reduce the probability of interference from adjacent signals.

4.4 Multicarrier Operation. If two transmitters are operated simultaneously and sent or received through the same antenna system, interference due to intermodulation is likely at  $(2f_1 - f_2)$  and

$(2f_2 - f_1)$ . Between three transmitters, the two-frequency possibilities exist, but intermodulation products may exist as well at  $(f_1 + f_2 - f_3)$ ,  $(f_1 + f_3 - f_2)$ , and  $(f_2 + f_3 - f_1)$ , where  $f_1$ ,  $f_2$ , and  $f_3$  represent the output frequencies of the transmitters. Intermodulation products can arise from nonlinearities in the transmitter output circuitry that cause mixing products between a transmitter output signal and the fundamental signal coming from nearby transmitters. Intermodulation products also can arise from nonlinearities in the antenna systems. The generation of intermodulation products is inevitable, but the effects are generally of concern only when such products exceed -25 dBm. The general rule for avoiding third-order intermodulation interference is that in any group of transmitter frequencies, the separation between any pair of frequencies should not be equal to the separation between any other pair of frequencies. Because individual signals have sidebands, it should be noted that intermodulation products have sidebands spectrally wider than the sidebands of the individual signals that caused them.

4.5 Transmitter Antenna System Emission Testing. Radiated tests will be made in lieu of transmitter output tests only when the transmitter is inaccessible. Radiated tests may still be required if the antenna is intended to be part of the filtering of spurious products from the transmitter or is suspected of generating spurious products by itself or in interaction with the transmitter and feed lines. These tests should be made with normal modulation.

## 5.0 Bandwidth

The definitions of bandwidth in this section are universally applicable. The limits shown here are applicable for telemetry operations in the telemetry bands 1435 to 1535, 2200 to 2290, and 2310 to 2390 MHz. For the purposes of telemetry signal spectral occupancy, the bandwidths used are the 99-percent power bandwidth and the -25 dBm bandwidth. A power level of -25 dBm is exactly equivalent to an attenuation of the transmitter power by  $55 + 10 \times \log(P)$  dB where P is the transmitter power expressed in watts. How bandwidth is actually measured and what the limits are, expressed in terms of that measuring system, are detailed in the following paragraphs.

5.1 Concept. The term "bandwidth" has an exact meaning in situations where an amplitude modulation (AM), double sideband (DSB), or single sideband (SSB) signal is produced with a band-limited modulating signal. In systems employing frequency modulation (FM) or phase modulation (PM), or any modulation system where the modulating signal is not band limited, bandwidth is infinite with energy extending toward zero and infinite frequency falling off from the peak value in some exponential fashion. In this more general case, bandwidth is defined as the band of frequencies in which most of the signal's energy is contained. The definition of "most" is imprecise. The following terms are applied to bandwidth.

5.1.1 Authorized Bandwidth. For purposes of this document, the authorized bandwidth is the necessary bandwidth required for transmission and reception of intelligence and does not include allowance for transmitter drift or Doppler shift.

5.1.2 Occupied Bandwidth. The width of a frequency band such that below the lower and above the upper frequency limits, the mean powers emitted are each equal to a specified percentage of the total mean power of a given emission. Unless otherwise specified by the International

Telecommunication Union (ITU) for the appropriate class of emission, the specified percentage shall be 0.5 percent. The occupied bandwidth is also called the 99-percent power bandwidth.

5.1.3 Necessary Bandwidth For a Given Class of Emission. For a given class of emission, the width of the frequency band which is just sufficient to ensure the transmission of information at the rate and with the quality required under specified conditions.

5.1.3.1 The NTIA Manual of Regulations and Procedures for Federal Radio Frequency Management states that "All reasonable effort shall be made in equipment design and operation by Government agencies to maintain the occupied bandwidth of the emission of any authorized transmission as closely to the necessary bandwidth as is reasonably practicable."

5.1.3.2 Necessary Bandwidth (DD Form 1494). The necessary bandwidth is part of the emission designator on the DD Form 1494. For telemetry purposes, the necessary bandwidth can be calculated using the equations shown below. Equations for other modulation methods are contained in the NTIA Manual of Regulations and Procedures for Federal Radio Frequency Management. The necessary bandwidth as calculated below is a reasonable bandwidth to use for telemetry frequency scheduling.

Filtered non-return-to-zero (NRZ) pulse code modulation/frequency modulation (PCM/FM)

$B_n = 2.4 \times \text{bit rate}$  with  $h=0.7$  and premodulation filter bandwidth = 0.7 times bit rate.

Example: PCM/FM modulation used to send 5 megabits per second using frequency modulation with 2 signaling states and 1.75 MHz peak deviation; bit rate= $5 \times 10^6$ ; necessary bandwidth ( $B_n$ ) = 12 MHz.

Constant envelope offset quadrature phase shift keying; Feher's patented quadrature phase shift keying (FQPSK-B, FQPSK-JR) or shaped offset quadrature phase shift keying (SOQPSK-TG)

$B_n = 1.3 \times \text{bit rate}$ . Example: SOPQSK-TG modulation used to send 5 megabits per second using 4 signaling states; bit rate= $5 \times 10^6$ ;  $B_n = 6.5$  MHz.

Advanced Range Telemetry (ARTM) Continuous Phase Modulation (CPM)

$B_n = \text{bit rate}$  with  $h=4/16$  and  $5/16$  on alternating symbols; Digital modulation used to send 5 megabits per second using frequency modulation with 4 signaling states and with alternating modulation index each symbol; bit rate= $5 \times 10^6$ ;  $B_n = 5$  MHz.

5.1.4 Received (or Receiver) Bandwidth. The received bandwidth is usually the -3 dB bandwidth of the receiver intermediate frequency (IF) section.

5.2 Bandwidth Estimation and Measurement. Various methods are used to estimate or measure the bandwidth of a signal that is not band limited. The bandwidth measurements are performed using a spectrum analyzer (or equivalent device) with the following settings: 30-kHz resolution bandwidth, 300-Hz video bandwidth, and no max hold detector or averaging. These settings are different than those in earlier versions of the Telemetry Standards. The settings were changed to get more consistent results across a variety of bit rates, modulation methods, and spectrum analyzers. The most common measurement and estimation methods are described in the following paragraphs.

5.2.1 99-Percent Power Bandwidth. This bandwidth contains 99 percent of the total power. The 99-percent power bandwidth is typically measured using a spectrum analyzer or estimated using equations for the modulation type and bit rate used. If the two points that define the edges of the band are not symmetrical about the assigned center frequency, their actual frequencies and difference should be noted. The 99-percent power band edges of randomized NRZ (RNRZ) PCM/FM signals are shown in Figure A-4 below. Table A-2 presents the 99-percent power bandwidth for several digital modulation methods as a function of the bit rate (R).

TABLE A-2. 99PERCENT POWER BANDWIDTHS FOR VARIOUS DIGITAL MODULATION METHODS	
DESCRIPTION	99% POWER BANDWIDTH
NRZ PCM/FM, premod filter BW=0.7R, $\Delta f=0.35R$	1.16 R
NRZ PCM/FM, no premod filter, $\Delta f=0.25R$	1.18 R
NRZ PCM/FM, no premod filter, $\Delta f=0.35R$	1.78 R
NRZ PCM/FM, no premod filter, $\Delta f=0.40R$	1.93 R
NRZ PCM/FM, premod filter BW=0.7R, $\Delta f=0.40R$	1.57 R
Minimum shift keying (MSK), no filter	1.18 R
FQPSK-B, FQPSK-JR or SQPSK-TG	0.78 R
ARTM CPM	0.56 R

5.2.2 -25 dBm Bandwidth. The -25 dBm bandwidth is the bandwidth containing all components larger than -25 dBm. A power level of -25 dBm is exactly equivalent to an attenuation of the transmitter power by  $55 + 10 \times \log(P)$  dB where P is the transmitter power expressed in watts. The -25 dBm bandwidth limits are shown in Figure A-4. The -25 dBm bandwidth is primarily a function of the modulation method, transmitter power, and bit rate. The transmitter design and construction techniques also strongly influence the -25 dBm bandwidth. With a bit rate of 5 Mb/s and a transmitter power of 5 watts the -25 dBm bandwidth of an NRZ PCM/FM system with near optimum parameter settings is about 13.3 MHz, while the -25 dBm bandwidth of an equivalent FQPSK-B system is about 7.5 MHz, and the -25 dBm bandwidth of an equivalent ARTM CPM system is about 5.8 MHz.

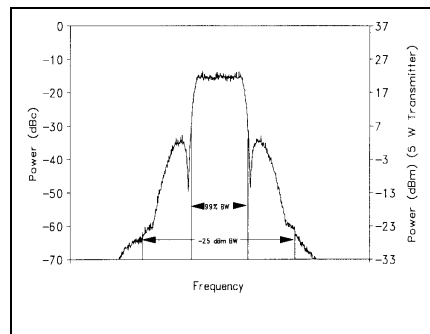

Figure A-4. RNRZ PCM/FM signal.



5.2.3 Other Bandwidth Measurement Methods. The methods discussed above are the standard methods for measuring the bandwidth of telemetry signals. The following methods are also sometimes used to measure or to estimate the bandwidth of telemetry signals.

5.2.3.1 Below Unmodulated Carrier. This method measures the power spectrum with respect to the unmodulated carrier power. To calibrate the measured spectrum on a spectrum analyzer, the unmodulated carrier power must be known. This power level is the 0-dB reference (commonly set to the top of the display). In AM systems, the carrier power never changes; in FM and PM systems, the carrier power is a function of the modulating signal. Therefore, a method to estimate the unmodulated carrier power is required if the modulation cannot be turned off. For most practical angle modulated systems, the total carrier power at the spectrum analyzer input can be found by setting the spectrum analyzer's resolution and video bandwidths to their widest settings, setting the analyzer output to max hold, and allowing the analyzer to make several sweeps (see Figure A-3 above). The maximum value of this trace will be a good approximation of the unmodulated carrier level. Figure A-5 shows the spectrum of a 5-Mb/s RNRZ PCM/FM signal measured using the standard spectrum analyzer settings discussed previously and the spectrum measured using 3-MHz resolution, video bandwidths, and max hold. The peak of the spectrum measured with the latter conditions is very close to 0-dBc and can be used to estimate the unmodulated carrier power (0-dBc) in the presence of frequency or phase modulation. In practice, the 0-dBc calibration would be performed first, and the display settings would then be adjusted to use the peak of the curve as the reference level (0-dBc level) to calibrate the spectrum measured using the standard spectrum analyzer settings. With the spectrum analyzer set for a specific resolution bandwidth, video bandwidth, and detector type, the bandwidth is taken as the distance between the two points outside of which the spectrum is thereafter some number (say, 60 dB) below the unmodulated carrier power determined above. The -60 dBc bandwidth for the 5-Mb/s signal shown in Figure A-5 is approximately 13 MHz.

The -60 dBc bandwidth of a random NRZ PCM/FM signal with a peak deviation of  $0.35R$ , a four-pole premodulation filter with -3 dB corner at  $0.7R$ , and a bit rate greater than or equal to 1 Mb/s can be approximated by

$$B_{-60\text{dBc}} = \{2.78 - 0.3 \times \log_{10}(R)\} \times R \quad (\text{A-3})$$

where B is in MHz and R is in Mb/s.

Thus the -60 dBc bandwidth of a 5-Mb/s RNRZ signal under these conditions would be approximately 12.85 MHz. The -60 dBc bandwidth will be greater if peak deviation is increased or the number of filter poles is decreased.

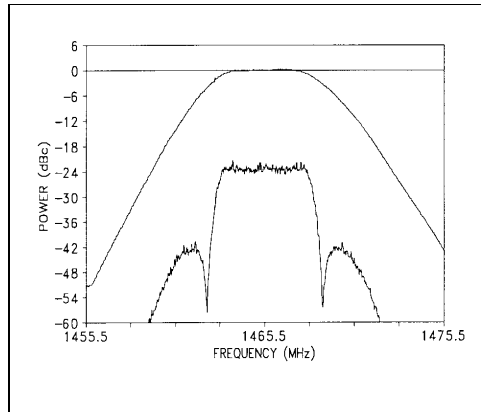

Figure A-5. Spectrum analyzer calibration of 0-dBc level

5.2.3.2 Below Peak. This method is not recommended

for measuring the bandwidth of telemetry signals. The modulated peak method, the least accurate measurement method, measures between points where the spectrum is thereafter XX dB below the level of the highest point on the modulated spectrum. Figure A-6 shows the radio frequency spectrum of a 400-kb/s Biφ-L PCM/PM signal with a peak deviation of 75° and a pre-modulation filter bandwidth of 800 kHz. The largest peak has a power level of -7 dBc. In comparison, the largest peak in Figure A-5 had a power level of -22 dBc. This 15-dB difference would skew a bandwidth comparison that used the peak level in the measured spectrum as a common reference point. In the absence of an unmodulated carrier to use for calibration, the below peak measurement is often (erroneously) used and described as a below unmodulated carrier measurement. Using max hold exacerbates this effect still further. In all instances the bandwidth is overstated, but the amount varies.

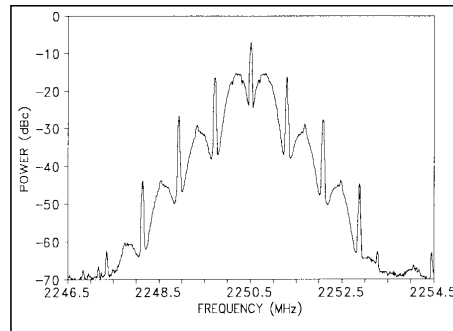

Figure A-6. Biφ PCM/PM signal

5.2.3.3 Carson's Rule. Carson's Rule is a method to estimate the bandwidth of an FM subcarrier system. Carson's Rule states that

$$B = 2 \times (\Delta f + f_{\max}) \tag{A-4}$$

where B is the bandwidth, Δf is the peak deviation of the carrier frequency, and f<sub>max</sub> is the highest frequency in the modulating signal. Figure A-7 shows the spectrum that results when a 12-channel constant bandwidth

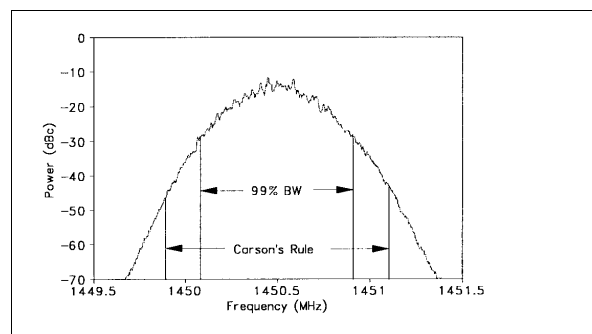

Figure A-7. FM/AM signal and Carson's Rule

multiplex with 6-dB/octave pre-emphasis frequency modulates an FM transmitter. The 99-percent power bandwidth and the bandwidth calculated using Carson's Rule are also shown. Carson's Rule will estimate a value greater than the 99-percent power bandwidth if little of the carrier deviation is due to high-frequency energy in the modulating signal.

5.2.4 Spectral Equations. The following equations can be used to calculate the RF spectra for several digital modulation methods with unfiltered waveforms.<sup>31, 32, 33</sup> These equations can be modified to include the effects of filtering.<sup>34, 35</sup>

- Random NRZ PCM/FM (valid when  $D \neq \text{integer}$ ,  $D = 0.5$  gives MSK spectrum)

$$S(f) = \frac{4 B_{SA}}{R} \left( \frac{D}{\pi(D^2 - X^2)} \right)^2 \frac{(\cos \pi D - \cos \pi X)^2}{1 - 2 \cos \pi D \cos \pi X + \cos^2 \pi D}, \quad \cos \pi D < Q \quad (\text{A-5})$$

- Random NRZ PSK

$$S(f) = \frac{B_{SA}}{R} \frac{\sin^2 \left( \frac{\pi X}{2} \right)}{\left( \frac{\pi X}{2} \right)^2} \quad (\text{A-6})$$

- Random NRZ QPSK and OQPSK

$$S(f) = \frac{2 B_{SA}}{R} \frac{\sin^2(\pi X)}{(\pi X)^2} \quad (\text{A-7})$$

- Random Bi $\phi$  PCM/FM

$$S(f) = \frac{B_{SA}}{4R} \left( \frac{\pi D}{2} \frac{\sin \left( \frac{\pi(X-D)}{4} \right)}{\frac{\pi(X-D)}{4}} \frac{\sin \left( \frac{\pi(X+D)}{4} \right)}{\frac{\pi(X+D)}{4}} \right)^2 + \left( \frac{D \sin \left( \frac{\pi D}{2} \right)}{\pi(X^2 - D^2)} \right)^2 \delta\{(f - f_c) - nR\} \quad (\text{A-8})$$

<sup>31</sup> I. Korn, Digital Communications, New York, Van Nostrand, 1985.

<sup>32</sup> M. G. Pelchat, "The Autocorrelation Function and Power Spectrum of PCM/FM with Random Binary Modulating Waveforms," IEEE Transactions, Vol. SET-10, No. 1, pp. 39-44, March 1964.

<sup>33</sup> W. M. Tey, and T. T. Tjhung, "Characteristics of Manchester-Coded FSK," IEEE Transactions on Communications, Vol. COM-27, pp. 209-216, January 1979.

<sup>34</sup> A. D. Watt, V. J. Zurick, and R. M. Coon, "Reduction of Adjacent-Channel Interference Components from Frequency-Shift-Keyed Carriers," IRE Transactions on Communication Systems, Vol. CS-6, pp. 39-47, December 1958.

<sup>35</sup> E. L. Law, "RF Spectral Characteristics of Random PCM/FM and PSK Signals," International Telemetry Conference Proceedings, pp. 71-80, 1991.

- Random Biφ PCM/PM

$$S(f) = \frac{B_{SA} \sin^2(\beta)}{R} \frac{\sin^4\left(\frac{\pi X}{4}\right)}{\left(\frac{\pi X}{4}\right)^2} + \cos^2(\beta) \delta(f - f_c), \quad \beta \leq \frac{\pi}{2} \quad (\text{A-9})$$

where

- S(f) = power spectrum (dBc) at frequency f
- B<sub>SA</sub> = spectrum analyzer resolution bandwidth\*
- R = bit rate
- D = 2Δf/R
- X = 2(f-f<sub>c</sub>)/R
- Δf = peak deviation
- β = peak phase deviation in radians
- f<sub>c</sub> = carrier frequency
- δ = Dirac delta function
- n = 0, ±1, ±2, ...
- Q = quantity related to narrow band spectral peaking when D≈1, 2, 3, ...
- Q ≈ 0.99 for B<sub>SA</sub> = 0.003 R, Q ≈ 0.9 for B<sub>SA</sub> = 0.03 R

\*The spectrum analyzer resolution bandwidth term was added to the original equations.

5.2.5 Receiver Bandwidth. Receiver predetection bandwidth is typically defined as the points where the response to the carrier before demodulation is -3 dB from the center frequency response. The carrier bandwidth response of the receiver is, or is intended to be, symmetrical about the carrier in most instances. Figure A-8 shows the response of a typical older generation telemetry receiver with RLC IF filters and a 1 MHz IF bandwidth selected. Outside the stated bandwidth, the response usually falls fairly rapidly with the response often 20 dB or more below the passband response at 1.5 to 2 times the passband response.

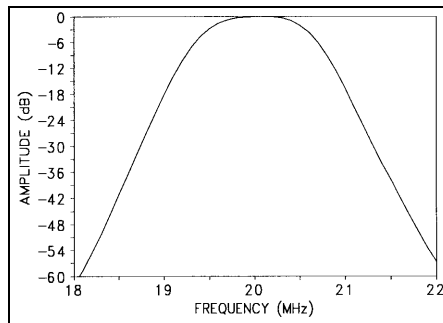
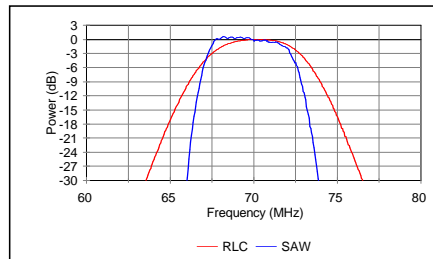

Figure A-8. Typical receiver RLC IF filter response (-3 dB bandwidth = 1 MHz).

Figure A-9 shows an overlay of an RLC IF filter and a surface acoustic wave (SAW) filter. Note that the SAW filter rolls off much more rapidly than the RLC filter. The rapid falloff outside the passband helps reduce interference from nearby channels and has minimal effect on data.



filters

5.2.6 Receiver Noise Bandwidth. For the purpose of calculating noise in the receiver, the bandwidth must be integrated over the actual shape of the IF, which, in general, is not a square-sided function. Typically, the value used for noise power calculations is the -3 dB bandwidth of the receiver.

5.3 Symmetry. Many modulation methods produce a spectrum that is asymmetrical with respect to the carrier frequency. Exceptions include FM/FM systems, randomized NRZ PCM/FM systems, and randomized FQPSK, SOQPSK-TG, and ARTM CPM systems. The most extreme case of asymmetry is due to single-sideband transmission, which places the carrier frequency at one edge of the occupied spectrum. If the spectrum is not symmetrical about the band center, the bandwidth and the extent of asymmetry must be noted for frequency management purposes.

5.4 FM Transmitters (ac coupled). The ac-coupled FM transmitters should not be used to transmit NRZ signals unless the signals to be transmitted are randomized because changes in the ratio of “ones” to “zeros” will increase the occupied bandwidth and may degrade the bit error rate. When ac-coupled transmitters are used with randomized NRZ signals, it is recommended that the lower -3 dB frequency response of the transmitter be no greater than the bit rate divided by 4000. For example, if a randomized 1-Mb/s NRZ signal is being transmitted, the lower -3 dB frequency response of the transmitter should be no larger than 250 Hz.

## 6.0 Spectral Occupancy Limits

Telemetry applications covered by this standard shall use 99-percent power bandwidth to define occupied bandwidth and -25 dBm bandwidth as the primary measure of spectral efficiency. The spectra are assumed symmetrical about the center frequency unless otherwise specified. The primary reason for controlling the spectral occupancy is to control adjacent channel interference, thereby allowing more users to be packed into a given amount of frequency spectrum. The adjacent channel interference is determined by the spectra of the signals and the filter characteristics of the receiver.

6.1 Spectral Mask. One common method of describing the spectral occupancy limits is a spectral mask. The aeronautical telemetry spectral mask is described below. Note that the mask in this standard is different than the masks contained in the earlier versions of the Telemetry Standards. All spectral components larger than  $-(55 + 10 \times \log(P))$  dBc, (i.e. larger than -25 dBm) at the transmitter output must be within the spectral mask calculated using the following equation:

$$M(f) = K + 90 \log R - 100 \log |f - f_c|; \quad |f - f_c| \geq \frac{R}{m} \quad (\text{A-10})$$

where

- $M(f)$  = power (dBc) at frequency  $f$  (MHz)
- $K$  = -20 for analog signals
- $K$  = -28 for binary signals
- $K$  = -61 for FQPSK-B, FQPSK-JR, SOQPSK-TG
- $K$  = -73 for ARTM CPM
- $f_c$  = transmitter center frequency (MHz)
- $R$  = bit rate (Mb/s) for digital signals or  $(\Delta f + f_{\max})(\text{MHz})$  for analog FM signals
- $m$  = number of states in modulating signal;
  - $m = 2$  for binary signals
  - $m = 4$  for quaternary signals and analog signals
- $\Delta f$  = peak deviation
- $f_{\max}$  = maximum modulation frequency

These bandwidths are measured using a spectrum analyzer with settings of 30-kHz resolution bandwidth, 300-Hz video bandwidth, and no max hold detector or averaging. Note that these settings are different than those listed in previous editions of the Telemetry Standards. The changes were made to get more consistent results with various bit rates and spectrum analyzers. The spectra measured with these settings give slightly larger power levels than with the previous settings; this is why the value of “K” was changed from -63 to -61 for FQPSK and SOQPSK signals. The power levels near center frequency should be approximately  $J - 10 \log(R)$  dBc where  $J = -10$  for ARTM CPM,  $-12$  for FQPSK and SOQPSK-TG, and  $-15.5$  for PCM/FM signals. For a bit rate of 5 Mb/s, the levels would be approximately -17 dBc for ARTM CPM, -19 dBc for FQPSK, and -22.5 dBc for PCM/FM. If the power levels near center frequency are not within 3 dB of these values, then a measurement problem exists and the carrier power level (0 dBc) and spectrum analyzer settings should be verified.

Deleted: -like

The -25 dBm bandwidth is not required to be narrower than 1 MHz. The first term “K” in equation (A-10) accounts for bandwidth differences between modulation methods. Equation (A-10) can be rewritten as  $M(f) = K - 10 \log R - 100 \log |(f - f_c)/R|$ . When equation (A-10) is written this way, the  $10 \log R$  term accounts for the increased spectral spreading and decreased power per unit bandwidth as the modulation rate increases. The last term forces the spectral mask to roll off at 30-dB/octave (100-dB/decade). Any error detection or error correction bits, which are added to the data stream, are counted as bits for the purposes of this spectral mask.

The spectral masks are based on the power spectra of random real-world transmitter signals. For instance, the binary signal spectral mask is based on the power spectrum of a binary NRZ PCM/FM signal with peak deviation equal to 0.35 times the bit rate and a multipole premodulation filter with a -3 dB frequency equal to 0.7 times the bit rate (see Figure A-4 above). This peak deviation minimizes the bit error rate (BER) with an optimum receiver bandwidth while also providing a compact RF spectrum. The premodulation filter attenuates the RF sidebands while only degrading the BER by the equivalent of a few tenths of a dB of RF power. Further decreasing of the premodulation filter bandwidth will only result in a slightly narrower RF spectrum, but the BER will increase dramatically. Increasing the premodulation filter bandwidth will result in a wider RF spectrum, and the BER will only be decreased slightly. The recommended premodulation filter for NRZ PCM/FM signals is a multipole linear phase filter with a -3 dB frequency equal to 0.7 times the bit rate. The unfiltered NRZ PCM/FM signal rolls off at 12-dB/octave so at least a three-pole filter (filters with four or more poles are recommended) is required to achieve the 30-dB/octave slope of the spectral mask. The spectral mask includes the effects of reasonable component variations (unit-to-unit and temperature).

## 6.2 Spectral Mask Examples.

Figures A-10 and A-11 show the binary spectral mask of equation (A-10) and the RF spectra of 5-Mb/s randomized NRZ PCM/FM signals. The RF spectra were measured using a spectrum analyzer with 30-kHz resolution bandwidth, 300-Hz video bandwidth, and no max hold detector. The span of the frequency axis is 20 MHz. The transmitter power was 5 watts, and the peak deviation was 1750 kHz. The modulation signal for Figure A-10 was filtered with a 4-pole linear-phase filter with -3 dB frequency of 3500 kHz. All spectral components in Figure A-10 were contained within the spectral mask. The minimum value of the spectral mask was -62 dBc (equivalent to -25 dBm). The peak modulated signal power levels were about 22.5 dB below the unmodulated carrier level (-22.5 dBc). Figure A-11 shows the same signal with no premodulation filtering. The signal was not contained within the spectral mask when a premodulation filter was not used.

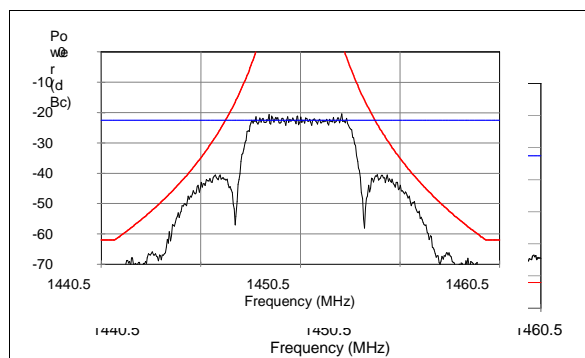

Figure A-10. Filtered 5-Mb/s NRZ PCM/FM signal and spectral mask.

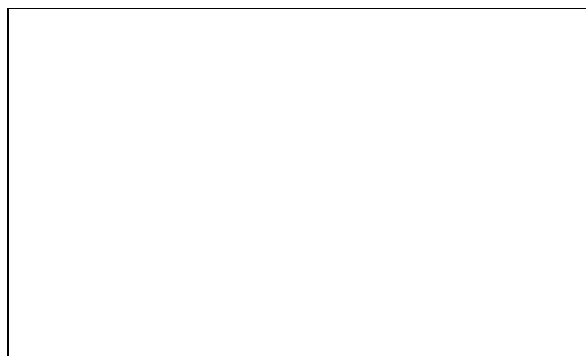

Figure A-11. Unfiltered 5-Mb/s NRZ PCM/FM signal and spectral mask.

Figure A-12 shows the FQPSK/SOQPSK mask of equation (A-10) and the RF spectrum of a 5-Mb/s SOQPSK-TG signal. The transmitter power was assumed to be 5 watts in this example. The peak value of the SOQPSK-TG signal was about -19 dBc. Figure A-13 shows a typical 5-Mb/s ARTM CPM signal and its spectral mask. The peak value of the ARTM CPM signal was about -17 dBc.

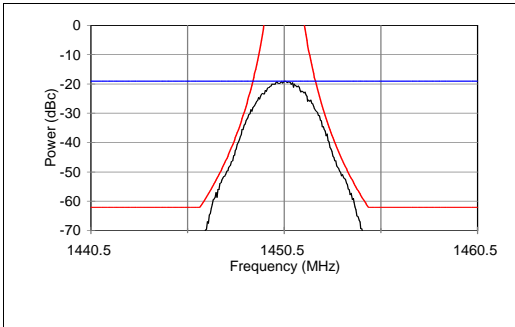

Figure A-12. Typical 5-Mb/s SOQPSK-TG signal and spectral mask.

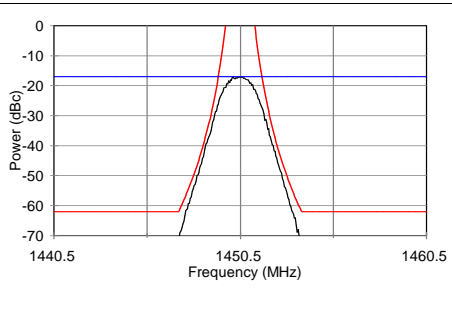

Figure A-13. Typical 5-Mb/s ARTM CPM signal and spectral mask.

## 7.0 Technical Characteristics of Digital Modulation Methods

Table A-3 provides a summary of some of the technical characteristics of the modulation methods discussed in this summary.

TABLE A-3. CHARACTERISTICS OF VARIOUS MODULATION METHODS.				
Characteristic	PCM/FM with single symbol detection	PCM/FM with multi-symbol detection	FQPSK-B, FQPSK-JR, SOQPSK-TG	ARTM CPM
Occupied Bandwidth	1.16 bit rate	1.16 bit rate	0.78 bit rate	0.56 bit rate
Sensitivity ( $E_b/N_0$ for BEP=1e-5)	11.8-15+ dB	9.5 dB	11.8-12.2 dB	12.5 dB
Synchronization time	100 to 10,000 bits	250 bits	5,000 to 30,000 bits	30,000 to 150,000 bits
Synchronization threshold level ( $E_b/N_0$ )	3 to 4 dB	2 dB	4.5 to 5 dB	8.5 dB
Phase noise susceptibility*	2	1	3	4
Co-channel interference susceptibility*	2	1	3	4

\* 1=Best, 2=Second Best, 3=Third Best, 4=Worst

- Deleted: 3
- Deleted: 3
- Deleted: 2
- Deleted: 1
- Deleted: 2 - 4
- Deleted: 1
- Deleted: 2
- Deleted: 3
- Deleted: 1
- Deleted: 2
- Deleted: 4
- Deleted: 1
- Deleted: 2
- Deleted: 1
- Deleted: 3
- Deleted: 4



## 8.0 FQPSK-B and FQPSK-JR Characteristics

Feher's-patented quadrature phase shift keying<sup>36, 37</sup> (FQPSK-B and FQPSK-JR) modulations are a variation of offset quadrature phase shift keying (OQPSK). OQPSK is described in most communications textbooks. A generic OQPSK (or quadrature or I & Q) modulator is shown in Figure A-14. In general, the odd bits are applied to one channel (say Q), and the even bits are applied to the I channel.

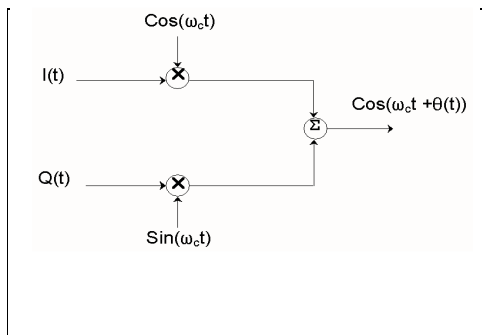

Figure A-14. OQPSK modulator.

If the values of I and Q are  $\pm 1$ , we get the diagram shown in Figure A-15. For example, if  $I=1$  and  $Q=1$  then the phase angle is 45 degrees  $\{(I,Q) = (1, 1)\}$ . A constant envelope modulation method, such as minimum shift keying (MSK), would follow the circle indicated by the small dots in Figure A-15 to go between the large dots. In general, band-limited QPSK and OQPSK signals are not constant envelope and would not follow the path indicated by the small dots but rather would have a significant amount of amplitude variation, however FQPSK-B and FQPSK-JR are nearly constant envelope and essentially follow the path indicated by the small dots in Figure A-15.

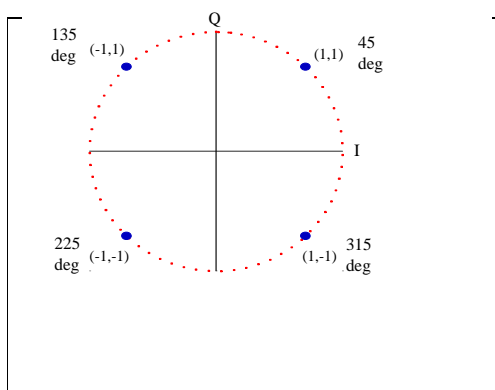

Figure A-15. I & Q constellation.

<sup>36</sup> K. Feher et al.: US Patents 4,567,602; 4,644,565; 5,491,457; and 5,784,402, post-patent improvements and other U.S. and international patents pending.

<sup>37</sup> Kato, Shuzo and Kamilo Feher, "XPSK: A New Cross-Correlated Phase Shift Keying Modulation Technique," IEEE Trans. Comm., vol. COM-31, May 1983.

The typical implementation of FQPSK-B or FQPSK-JR involves the application of data and a bit rate clock to the baseband processor of the quadrature modulator. The data are differentially encoded and converted to I and Q signals as described in Chapter 2. The I and Q channels are then cross-correlated, and specialized wavelets are assembled that minimize the instantaneous variation of  $(I^2(t) + Q^2(t))$ . The FQPSK-B baseband wavelets are illustrated in Figure A-16.

The appropriate wavelet is assembled based on the current and immediate past states of I and Q. Q is delayed by one-half symbol (one bit) with respect to I as shown in Figure A-17.

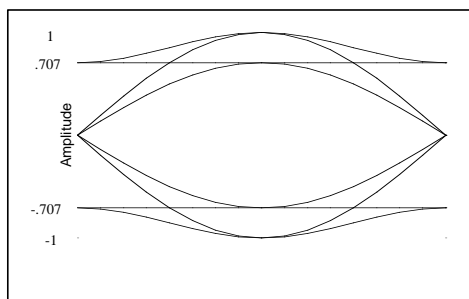

Figure A-16. FQPSK wavelet eye diagram.

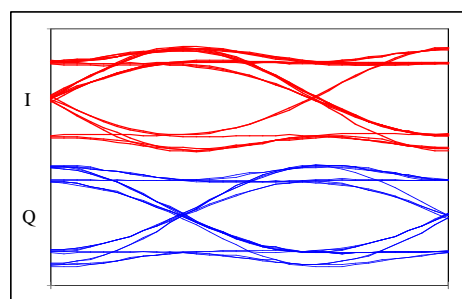

Figure A-17. FQPSK-B I & Q eye diagrams (at input to IQ modulator).

A common method of looking at I-Q modulation signals is called a vector diagram. One method of generating a vector diagram is to use an oscilloscope that has an XY mode. The vector diagram is generated by applying the I signal to the X input and the Q signal to the Y input. A sample vector diagram of FQPSK-B at the input terminals of an I-Q modulator is illustrated in Figure A-18. Note that the vector diagram values are always within a few percent of being on a circle. Any amplitude variations may cause spectral spreading at the output of a non-linear amplifier.

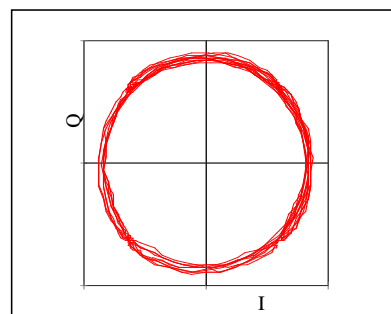

Figure A-18. FQPSK-B vector diagram.

Figure A-19 illustrates a nearly ideal FQPSK-JR spectrum (blue trace) and an FQPSK-JR spectrum with moderately large modulator errors (red trace). These spectra were measured at the output of a fully saturated RF non-linear amplifier with a random pattern of “1’s” and “0’s” applied to the input. The bit rate for Figure A-19 was 5 Mb/s. The peak of the spectrum was approximately  $-19$  dBc. The 99-percent bandwidth of FQPSK-B is typically about 0.78 times the bit rate. Note that with a properly randomized data sequence and proper transmitter design, FQPSK-B does not have significant sidebands (blue trace).

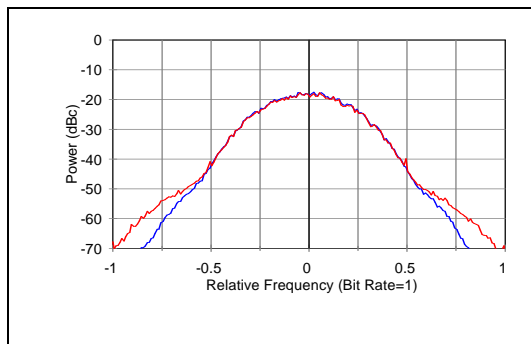

Figure A-19. 5 Mb/s FQPSK-JR spectrum with random input data and small (blue) and large (red) modulator errors.

Figure A-20 illustrates an FQPSK-B transmitter output with all “0’s” as the input signal. With an all “0’s” input, the differential encoder, cross-correlator, and wavelet selector provide unity amplitude sine and cosine waves with a frequency equal to 0.25 times the bit rate to the I and Q modulator inputs. The resulting signal (from an ideal modulator) would be a single frequency component offset from the carrier frequency by exactly  $+0.25$  times the bit rate. The amplitude of this component would be equal to 0 dBc. If modulator errors exist (they always will), additional frequencies will appear in the spectrum as shown in Figure A-20. The spectral line at a normalized frequency of 0 (carrier frequency) is referred to as the remnant carrier. This component is largely caused by DC imbalances in the I and Q signals. The remnant carrier power in Figure A-20 is approximately  $-31$  dBc. Well designed FQPSK-B transmitters will have a remnant carrier level less than  $-30$  dBc. The spectral component offset, 0.25 times the bit rate below the carrier frequency, is the other sideband. This component is largely caused by unequal amplitudes in I and Q and by a lack of quadrature between I and Q. The power in this component should be limited to  $-30$  dBc or less for good system performance.

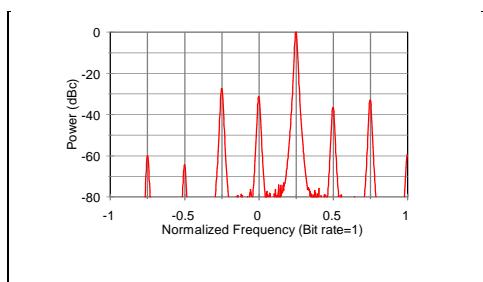

Figure A-20. FQPSK-B spectrum with all 0’s input and large modulator errors.

Figure A-21 shows the measured bit error probability (BEP) versus signal energy per bit/noise power per Hz ( $E_b/N_0$ ) of two FQPSK-JR modulator/demodulator combinations including non-linear amplification and differential encoding/decoding in an additive white Gaussian noise environment (AWGN) with no fading. Other combinations of equipment may have different performance. Phase noise levels higher than those recommended in Chapter 2 can significantly degrade the BEP performance. Computer simulations have shown that a BEP of  $10^{-5}$  may be achievable with an  $E_b/N_0$  of slightly greater than 11 dB (with differential

encoding/decoding). The purpose of the differential encoder/decoder is to resolve the phase detection ambiguities that are inherent in QPSK, OQPSK, and FQPSK modulation methods. The differential encoder/decoder used in this standard will cause one isolated symbol error to appear as two bits in error at the demodulator output. However, many aeronautical telemetry channels are dominated by fairly long burst error events, and the effect of the differential encoder/decoder will often be masked by the error events.

### 9.0 SOQPSK-TG Characteristics.

SOQPSK is a family of constant envelope continuous phase modulation (CPM) waveforms defined by Mr. T. Hill<sup>38, 39, 40, 41</sup>. The details of SOQPSK-TG are described in paragraphs 2.4.3.2 and 2.4.3.2.1 of this document. The SOQPSK-TG signal amplitude is constant and the phase trajectory is determined by the coefficients in Table 2-4. Therefore, SOQPSK-TG can be implemented using a precision phase or frequency modulator with proper control of the phase trajectory. Figure A-22 illustrates the measured phase trajectory of an SOQPSK-TG signal. The vertical lines correspond approximately to the “bit” decision times.



Figure A-21. FQPSK-JR BEP vs.  $E_b/N_0$ .

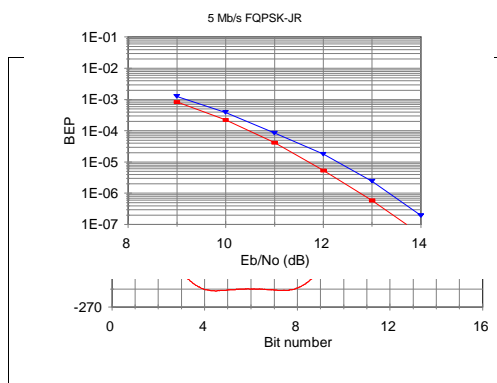

Figure A-22. Measured SOQPSK-TG phase trajectory

<sup>38</sup> Hill T., “An Enhanced, Constant Envelope, Interoperable Shaped Offset QPSK (SOQPSK) Waveform for Improved Spectral Efficiency”, Proceedings of the International Telemetry Conference, San Diego, California, October 2000.

<sup>39</sup> Younes B., Brase J., Patel C., Wesdock J., “An Assessment of Shaped Offset QPSK for Use in NASA Space Network and Ground Network Systems”, Meetings of Consultative Committee for Space Data Systems, Toulouse, France, October, 2000.

<sup>40</sup> Geoghegan, M., “Implementation and Performance Results for Trellis Detection of SOQPSK”, Proceedings of the International Telemetry Conference, Las Vegas, Nevada, October 2001.

<sup>41</sup> Simon, M., Bandwidth-Efficient Digital Modulation with Application to Deep Space Communications, Monograph number 3, DESCANSO Monograph Series, JPL Publication 00-17, Jet Propulsion Laboratory, California Institute of Technology, 2001. This publication is available free via the Internet: <http://descanso.jpl.nasa.gov/Monograph/series3/complete1.pdf> (note: do not use WWW prefix for this URL).

The power spectrum of a random 5 Mb/s SOQPSK-TG signal is shown in Figure A-23. The -60 dBc bandwidth of this 5 Mb/s signal was about 7.34 MHz. Note that the maximum power level is about -19 dBc.

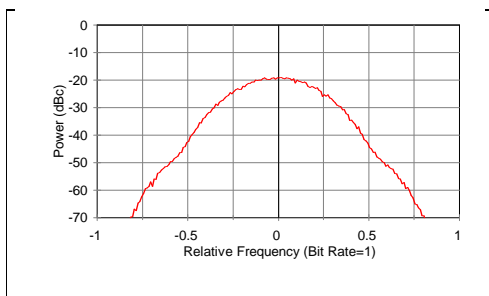

Figure A-23. SOQPSK-TG Power Spectrum (5 Mb/s).

Figure A-24 shows the measured bit error probability (BEP) versus signal energy per bit/noise power per Hz ( $E_b/N_0$ ) of two SOQPSK-TG modulator/demodulator combinations including non-linear amplification and differential encoding/decoding in an additive white Gaussian noise environment (AWGN) with no fading. Other combinations of equipment may have different performance. Phase noise levels higher than those recommended in Chapter 2 can significantly degrade the BEP performance.

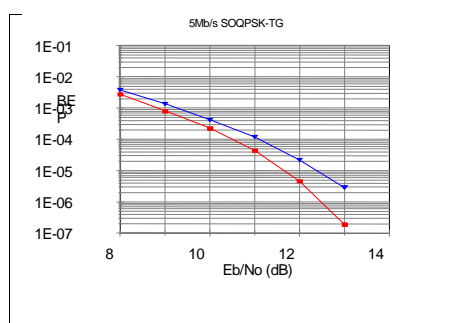

Figure A-24. BEP versus  $E_b/N_0$  performance of 5 Mb/s SOQPSK-TG.

## 10.0 Advanced Range Telemetry (ARTM) CPM Characteristics.

ARTM CPM is a quaternary signaling scheme in which the instantaneous frequency of the modulated signal is a function of the source data stream. The frequency pulses are shaped for spectral containment purposes. As defined for this standard, the modulation index alternates at the symbol rate between  $h=4/16$  and  $h=5/16$ . The purpose of alternating between two modulation indices is to maximize the minimum distance between data symbols, which results in minimizing the bit error probability. These particular modulation indices were selected as a good tradeoff between spectral efficiency and data-detection ability. Figure A-25 shows the power spectrum of a 5 Mb/s ARTM CPM signal and Figure A-26 shows

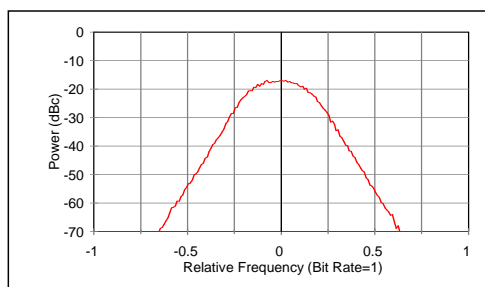

Figure A-25. Power spectrum of 5 Mb/s ARTM CPM.

the measured BEP versus  $E_b/N_o$ . The maximum power level was about  $-19$  dBc. The  $-60$  dBc bandwidth of this 5 Mb/s signal was about 5.54 MHz. Note that the power spectrum of ARTM CPM is about 25% narrower than that of SOQPSK-TG but the BEP performance is worse. ARTM CPM is also more susceptible to phase noise than SOQPSK-TG.

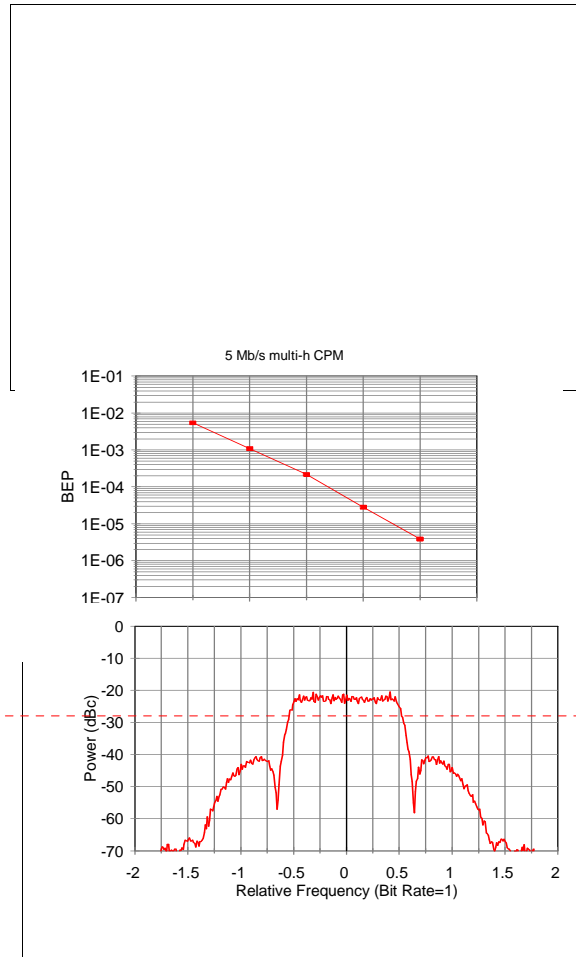

Figure A-27. Power spectrum of 5 Mb/s PCM/FM signal.

### 11.0 PCM/FM

Pulse code modulation (PCM)/frequency modulation (FM) has been the most popular telemetry modulation since about 1970. This method could also be called filtered continuous phase frequency shift keying (CPFSK). The RF signal is typically generated by filtering the baseband non-return-to-zero-level (NRZ-L) signal and then frequency modulating a voltage controlled oscillator (VCO). The optimum peak deviation is 0.35 times the bit rate ( $h=0.7$ ) and a good choice for a premodulation filter is a multi-pole linear phase filter with bandwidth equal to 0.7 times the bit rate. Figure A-27 shows the power spectrum of a pseudo-random 5 Mb/s PCM/FM signal with peak deviation of 1.75 MHz and a 3.5 MHz linear phase low-pass filter. Note that the spectrum is nearly flat from a frequency equal to  $-0.5$  times the bit rate to a frequency equal to  $+0.5$  times the bit rate. The power level near the center frequency is about  $-22.5$  dBc for a bit rate of 5 Mb/s and the standard spectrum analyzer settings.

Deleted: from at least 1970-2003

Figure A-28 shows the BEP versus  $E_b/N_o$  performance of 5 Mb/s PCM/FM with a multi-symbol bit detector and with 3 different receivers/detectors. Note that an  $E_b/N_o$  of about 9.5 dB is required to achieve a BEP of about  $10^{-5}$  with the multi-symbol detector<sup>42, 43</sup> while an  $E_b/N_o$  of about 12 to 14 dB is typically required to achieve a BEP of about  $10^{-5}$  with typical FM demodulators and single symbol detectors. The PCM/FM modulation method is fairly insensitive to phase noise.

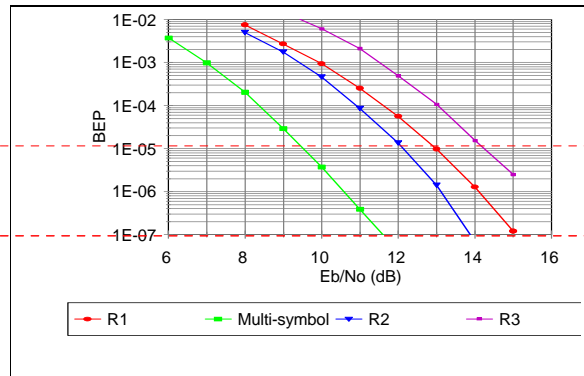

Figure A-28. BEP versus  $E_b/N_o$  performance of 5 Mb/s PCM/FM with multi-symbol bit detector and three single symbol receivers/detectors.

Deleted: 4

Deleted: or

Deleted: 13

<sup>42</sup> Osborne W.P., Luntz M.B., "Coherent and Noncoherent Detection of CPFASK", IEEE Transactions on Communications, August 1974.

<sup>43</sup> Geoghegan M.S., "Improving the Detection Efficiency of Conventional PCM/FM Telemetry by using a Multi-Symbol Demodulator", Proceedings of the 2000 International Telemetry Conference, Volume XXXVI, 675-682, San Diego CA, October 2000.

This page intentionally left blank.



## APPENDIX B

### USE CRITERIA FOR FREQUENCY DIVISION MULTIPLEXING

#### 1.0 General

Successful application of frequency division multiplexing telemetry standards depends on recognition of performance limits and performance tradeoffs, which may be required in implementation of a system. The use criteria included in this Appendix are offered in this context as a guide for orderly application of the standards, which are presented in Chapter 3. It is the responsibility of the telemetry system designer to select the range of performance that will meet data measurement requirements and at the same time permit operation within the limits of the standards. A designer or user must also recognize the fact that even though the standards for FM/FM multiplexing encompass a broad range of performance limits, tradeoffs such as data accuracy for data bandwidth may be necessary. Nominal values for such parameters as frequency response and rise time are listed to indicate the majority of expected use and should not be interpreted as inflexible operational limits. It must be remembered that system performance is influenced by other considerations such as hardware performance capabilities. In summary, the scope of the standards together with the use criteria is intended to offer flexibility of operation and yet provide realistic limits.

#### 2.0 FM Subcarrier Performance

The nominal and maximum frequency response of the subcarrier channels listed in Tables [3-1A](#), [3-1B](#) and [3-1C](#) and Table [3-2](#) is 10 and 50 percent of the maximum allowable deviation bandwidth. The nominal frequency response of the channels employs a deviation ratio of five. The deviation ratio of a channel is one-half the defined deviation bandwidth divided by the cutoff frequency of the discriminator output filter.

2.1 The use of other deviation ratios for any of the subcarrier channels listed may be selected by the range users to conform with the specific data response requirements for the channel. As a rule, the rms signal-to-noise ratio (SNR) of a specific channel varies as the three-halves power of that subcarrier deviation ratio.

2.2 The nominal and minimum channel rise times indicated in Tables [3-1A](#), [3-1B](#) and [3-1C](#) and Table [3-2](#) have been determined from the equation which states that rise time is equal to 0.35 divided by the frequency response for the nominal and maximum frequency response. The equation is normally employed to define 10 to 90 percent rise time for a step function of the channel input signal. However, deviations from these values may be encountered because of variations in subcarrier components in the system.

### 3.0 FM Subcarrier Performance Tradeoffs

The number of subcarrier channels that may be used simultaneously to modulate an RF carrier is limited by the RF channel bandwidth and by the output SNR that is acceptable for the application at hand. As channels are added, it is necessary to reduce the transmitter deviation allowed for each individual channel to keep the overall multiplex within the RF channel assignment. This reduction lowers the subcarrier-to-noise performance at the discriminator inputs. Thus, the system designer's problem is to determine acceptable tradeoffs between the number of subcarrier channels and acceptable subcarrier-to-noise ratios.

3.1 Background information relating to the level of performance and the tradeoffs that may be made is included in Telemetry FM/FM Baseband Structure Study, volumes I and II; which were completed under a contract administered by the Telemetry Working Group of the IRIG in 1965. The results of the study show that proportional bandwidth channels with center frequencies up to 165 kHz and constant bandwidth channels with center frequencies up to 176 kHz may be used within the constraints of these standards. The test criteria included the adjustment of the system components for approximately equal SNRs at all of the discriminator outputs with the receiver input near RF threshold. Intermodulation, caused by the radio-link components carrying the composite multiplex signal, limits the channel's performance under large signal conditions.

**Comment [VR1]:** The RCC cannot locate this study, nor does it appear to be at current DTIC publications.

3.2 With subcarrier deviation ratios of four, channel data errors on the order of 2 percent rms were observed. Data channel errors on the order of 5 percent rms of full-scale bandwidth were observed when subcarrier deviation ratios of two were employed. When deviation ratios of one were used, it was observed that channel-data errors exceeded 5 percent. Some channels showed peak-to-peak errors as high as 30 percent. It must be emphasized, however, that the results of the tests performed in this study are based on specific methods of measurement on one system sample and that this system sample represents a unique configuration of components. Systems having different performance characteristics may not yield the same system performance.

3.3 System performance may be improved, in terms of better data accuracy, by sacrificing system data bandwidth; that is, if the user is willing to limit the number of subcarrier channels in the multiplex, particularly the higher frequency channels, the input level to the transmitter can be increased. The SNR of each subcarrier is then improved through the increased per-channel transmitter deviation. For example, the baseband structure study indicated that when the 165-kHz channel and the 93-kHz channel were not included in the proportional-bandwidth multiplex, performance improvement can be expected in the remaining channels equivalent to approximately 12 dB increased transmitter power.

3.4 Likewise, elimination of the five highest frequency channels in the constant bandwidth multiplex allowed a 6-dB increase in performance.

3.5 A general formula,<sup>44</sup> which can be used to estimate the thermal noise performance of an FM/FM channel above threshold, is as follows:

---

<sup>44</sup> K.M. Uglow, *Noise and Bandwidth in FM/FM Radio Telemetry*, "IRE Transaction on Telemetry and Remote Control," (May 1957) pp 19-22.

$$\left(\frac{S}{N}\right)_d = \left(\frac{S}{N}\right)_c \left(\frac{3}{4}\right)^{1/2} \left[\frac{B_c}{F_{ud}}\right]^{1/2} \left(\frac{f_{dc}}{f_s}\right) \left(\frac{f_{ds}}{F_{ud}}\right) \quad (\text{B-1})$$

where:

$\left(\frac{S}{N}\right)_d$  = discriminator output signal-to-noise ratio (rms voltage ratio)

$\left(\frac{S}{N}\right)_c$  = receiver carrier-to-noise ratio (rms voltage ratio)

$B_c$  = carrier bandwidth (receiver IF bandwidth)

$F_{ud}$  = subcarrier discriminator output filter: 3-dB frequency

$f_s$  = subcarrier center frequency

$f_{dc}$  = carrier peak deviation of the particular subcarrier of interest

$f_{ds}$  = subcarrier peak deviation

If the RF carrier power is such that the thermal noise is greater than the intermodulation noise, the above relation provides estimates accurate to within a few decibels. Additional information is contained in RCC Document 119, *Telemetry Applications Handbook*.

3.6 The FM/FM composite-multiplex signal used to modulate the RF carrier may be a proportional-bandwidth format, a constant-bandwidth format, or a combination of the two types provided only that guard bands allowed for channels used in a mixed format be equal to or greater than the guard band allowed for the same channel in an unmixed format.

#### 4.0 FM System Component Considerations

System performance is dependent on all components in the system. Neglecting the effects of the RF and recording system, data channel accuracy is primarily a function of the linearity and frequency response of the subcarrier oscillators and discriminators employed. Systems designed to transmit data frequencies up to the nominal frequency responses shown in Tables [3-1A](#), [3-1B](#) and [3-1C](#) and [3-2](#) have generally well-known response capabilities, and reasonable data accuracy estimates can be easily made. For data-channel requirements approaching the maximum frequency response of Tables [3-1A](#), [3-1B](#) and [3-1C](#) and [3-2](#), oscillator and discriminator characteristics are less consistent and less well-defined, making data accuracy estimates less dependable.

4.1 The effect of the RF system on data accuracy is primarily in the form of noise because of intermodulation at high RF signal conditions well above threshold. Under low RF signal conditions, noise on the data channels is increased because of the degraded SNR existing in the receiver.

4.2 Intermodulation of the subcarriers in a system is caused by characteristics such as amplitude and phase nonlinearities of the transmitter, receiver, magnetic tape recorder/reproducer, or other system components required to handle the multiplex signal under the modulation conditions employed. In systems employing pre-emphasis of the upper subcarriers, the lower subcarriers may experience intermodulation interference because of the difference frequencies of the high-frequency and high-amplitude channels.

4.3 The use of magnetic tape recorders for recording a subcarrier multiplex may degrade the data channel accuracy because of the tape speed differences or variations between record and playback. These speed errors can normally be compensated for in present discriminator systems when the nominal response rating of the channels is employed and a reference frequency is recorded with the subcarrier multiplex.

## **5.0 Range Capability For FM Subcarrier Systems**

The following subparagraphs outline additional range capabilities:

5.1 Receivers and Tape Recorders. The use of subcarrier frequencies greater than 2 MHz may require tape recorders of a greater capability than are in current use at some ranges. It is recommended that users, who anticipate employing any of the above channels at a range, check the range's capability at a sufficiently early date to allow procurement of necessary equipment.

5.2 Discriminator Channel Selection Filters. Inclusion of the higher frequency proportional-bandwidth channels and the constant-bandwidth channels may require the ranges to acquire additional band selection filters. In addition to referencing Tables [3-1A](#), [3-1B](#) and [3-1C](#), and [3-2](#) for acquiring channel-selector filters, consideration should also be given to acquiring discriminators corresponding to the predetection carrier frequencies shown in Table [6-6](#). In applications where minimum time delay variation within the filter is important, such as tape speed compensation or high-rate PAM or PCM, constant-delay filter designs are recommended.

## APPENDIX C

### PCM STANDARDS (ADDITIONAL INFORMATION AND RECOMMENDATIONS)

#### 1.0 Bit Rate Versus Receiver Intermediate-Frequency Bandwidth

The following subparagraphs contain information about selection of receiver intermediate-frequency (IF) bandwidths. Additional information is contained in RCC document 119, *Telemetry Applications Handbook*.

1.1 The standard receiver IF bandwidth values are listed in Table 2-1. Not all bandwidths are available on all receivers or at all test ranges. Additional bandwidths may be available at some test ranges. The IF bandwidth, for data receivers, should typically be selected so that 90 to 99 percent of the transmitted power spectrum is within the receiver 3-dB bandwidth.

1.2 For reference purposes, in a well-designed PCM/FM system (NRZ-L data code) with peak deviation equal to 0.35 times the bit rate and an IF bandwidth (3 dB) equal to the bit rate, a receiver IF signal-to-noise ratio (SNR) of approximately 13 dB will result in a bit error probability (BEP) of  $10^{-6}$ . A 1-dB change in this SNR will result in approximately an order of magnitude change in the BEP. The relationship between BEP and IF SNR in a bandwidth equal to the bit rate is illustrated in Figure C-1 for IF bandwidths equal to the bit rate and 1.5 times the bit rate. An approximate expression for the BEP is

$$\text{BEP} = 0.5 e^{(k \cdot \text{SNR})} \quad (\text{C-1})$$

where:

$k \approx -0.7$  for IF bandwidth equal to bit rate

$k \approx -0.65$  for IF bandwidth equal to 1.2 times bit rate

$k \approx -0.55$  for IF bandwidth equal to 1.5 times bit rate

$\text{SNR} = \text{IF SNR} \cdot \text{IF bandwidth/bit rate}$ .

Other data codes and modulation techniques have different BEP versus SNR performance characteristics.

1.3 It is recommended that the maximum period between bit transitions be 64-bit intervals to ensure adequate bit synchronization. Table C-1 contains recommended frame synchronization patterns for general use in PCM telemetry.

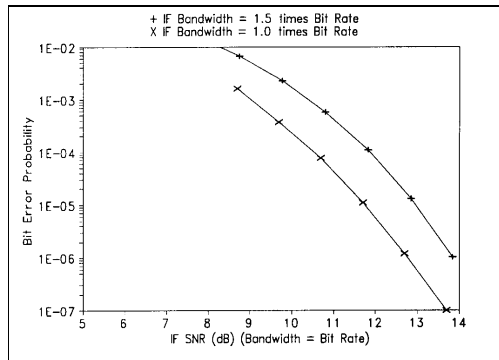

Figure C-1. BEP vs IF SNR in bandwidth = bit rate for NRZ-L PCM/FM.

## 2.0 Recommended PCM Synchronization Patterns

Table C-1 contains recommended frame synchronization patterns for general use in PCM telemetry. Patterns are shown in the preferred order of transmission with "111" being the first bit sequence transmitted. This order is independent of data being LSB or MSB aligned. The technique used in the determination of the patterns for lengths 16 through 30 was essentially that of the patterns of  $2^n$  binary patterns off a given length,  $n$ , for that pattern with the smallest total probability of false synchronization over the entire pattern overlap portion of the ground station frame synchronization.<sup>45</sup> The patterns for lengths 31 through 33 were obtained from a second source.<sup>46</sup>

## 3.0 Spectral and BEP Comparisons for NRZ and Bi $\phi$ <sup>47</sup>

Figure C-2 shows the power spectral densities of baseband NRZ and Bi $\phi$  codes with random data. These curves were calculated using the equations presented below. Figure C-3 presents the theoretical bit error probabilities versus signal-to-noise ratio for the level, mark, and space versions of baseband NRZ and Bi $\phi$  codes and also for RNRZ-L. The noise is assumed to be additive white gaussian noise.

$$\text{NRZ SPECTRAL DENSITY} \propto \frac{\sin^2(\pi fT)}{(\pi fT)^2} \quad (\text{C-2})$$

$$\text{Bi}\phi \text{ SPECTRAL DENSITY} \propto \frac{\sin^4(\pi fT/2)}{(\pi fT/2)^2} \quad (\text{C-3})$$

where  $T$  is the bit period.

---

<sup>45</sup> A more detailed account of this investigation can be found in a paper by J. L. Maury, Jr. and J. Styles, "Development of Optimum Frame Synchronization Codes for Goddard Space Flight Center PCM Telemetry Standards," in *Proceedings of the National Telemetry Conference*, June 1964.

<sup>46</sup> The recommended synchronization patterns for lengths 31 through 33 are discussed more fully in a paper by E. R. Hill, "Techniques for Synchronizing Pulse-Code Modulated Telemetry," in *Proceedings of the National Telemetry Conference*, May 1963.

<sup>47</sup> Material presented in paragraph 3.0 is taken from a study by W. C. Lindsey (University of Southern California), *Bit Synchronization System Performance Characterization, Modeling and Tradeoff Study*, Naval Missile Center Technical Publication.

**TABLE C-1. OPTIMUM FRAME SYNCHRONIZATION PATTERNS FOR PCM TELEMETRY**

<u>Pattern Length</u>	<u>Patterns</u>										
16	111	010	111	001	000	0					
17	111	100	110	101	000	00					
18	111	100	110	101	000	000					
19	111	110	011	001	010	000	0				
20	111	011	011	110	001	000	00				
21	111	011	101	001	011	000	000				
22	111	100	110	110	101	000	000	0			
23	111	101	011	100	110	100	000	00			
24	111	110	101	111	001	100	100	000			
25	111	110	010	110	111	000	100	000	0		
26	111	110	100	110	101	100	110	000	00		
27	111	110	101	101	001	100	110	000	000		
28	111	101	011	110	010	110	011	000	000	0	
29	111	101	011	110	011	001	101	000	000	00	
30	111	110	101	111	001	100	110	100	000	000	
31	111	111	100	110	111	110	101	000	010	000	0
32	111	111	100	110	101	100	101	000	010	000	00
33	111	110	111	010	011	101	001	010	010	011	000

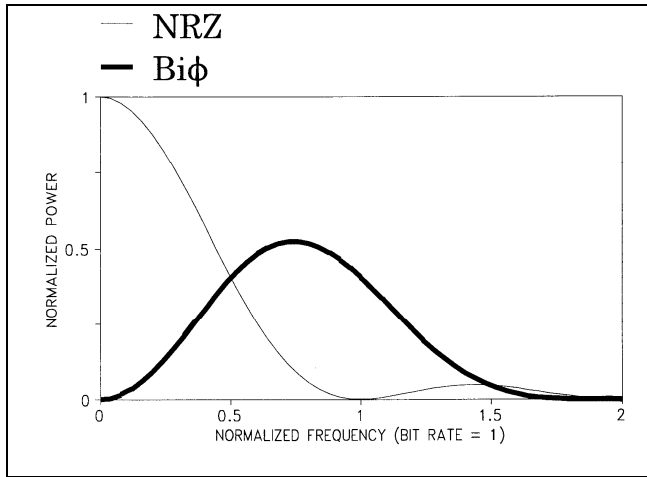

Figure C-2. Spectral densities of random NRZ and Biφ codes.

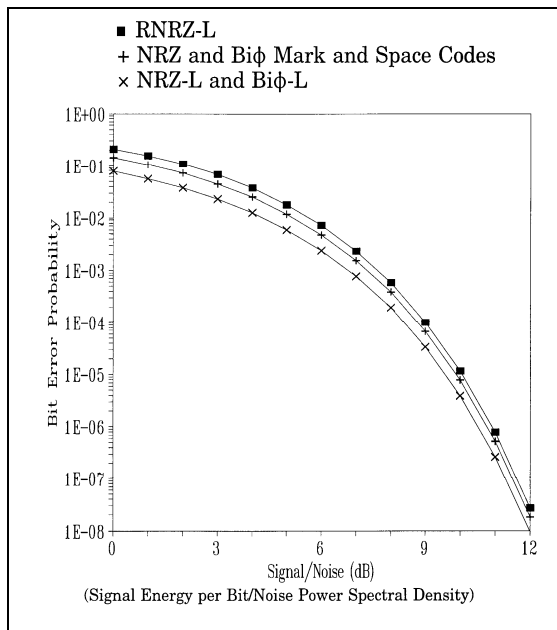

Figure C-3. Theoretical bit error probability performance for various baseband PCM signaling techniques (perfect bit synchronization assumed).



#### 4.0 PCM Frame Structure Examples

Figures C-4, C-5, and C-6 show examples of allowable PCM frame structures. In each example, the Minor Frame Sync Pattern is counted as one word in the minor frame. The first word after the Minor Frame Sync Pattern is word 1.

Figures C-5 and C-6 show the preferred method of placing the subframe ID counter in the minor frame. The counter is placed before the parameters that are referenced to it.

Major Frame Length is as follows:

Figure [C-4](#): Major Frame Length = Minor Frame Maximum Length.

Figure [C-5](#): Major Frame Length = Minor Frame Maximum Length multiplied by Z.

Figure [C-6](#): Major Frame Length = Minor Frame Maximum Length multiplied by Z.

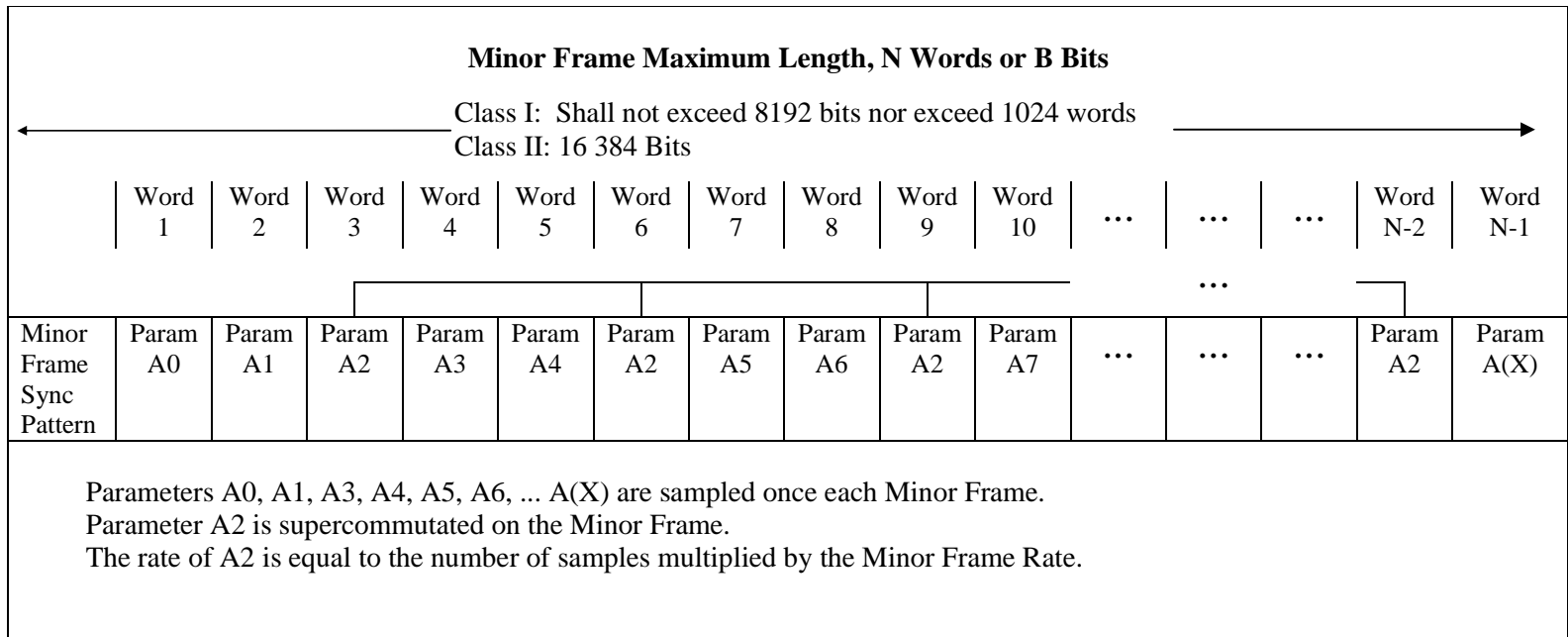

Figure C-4. Major Frame Length = Minor Frame Maximum Length.

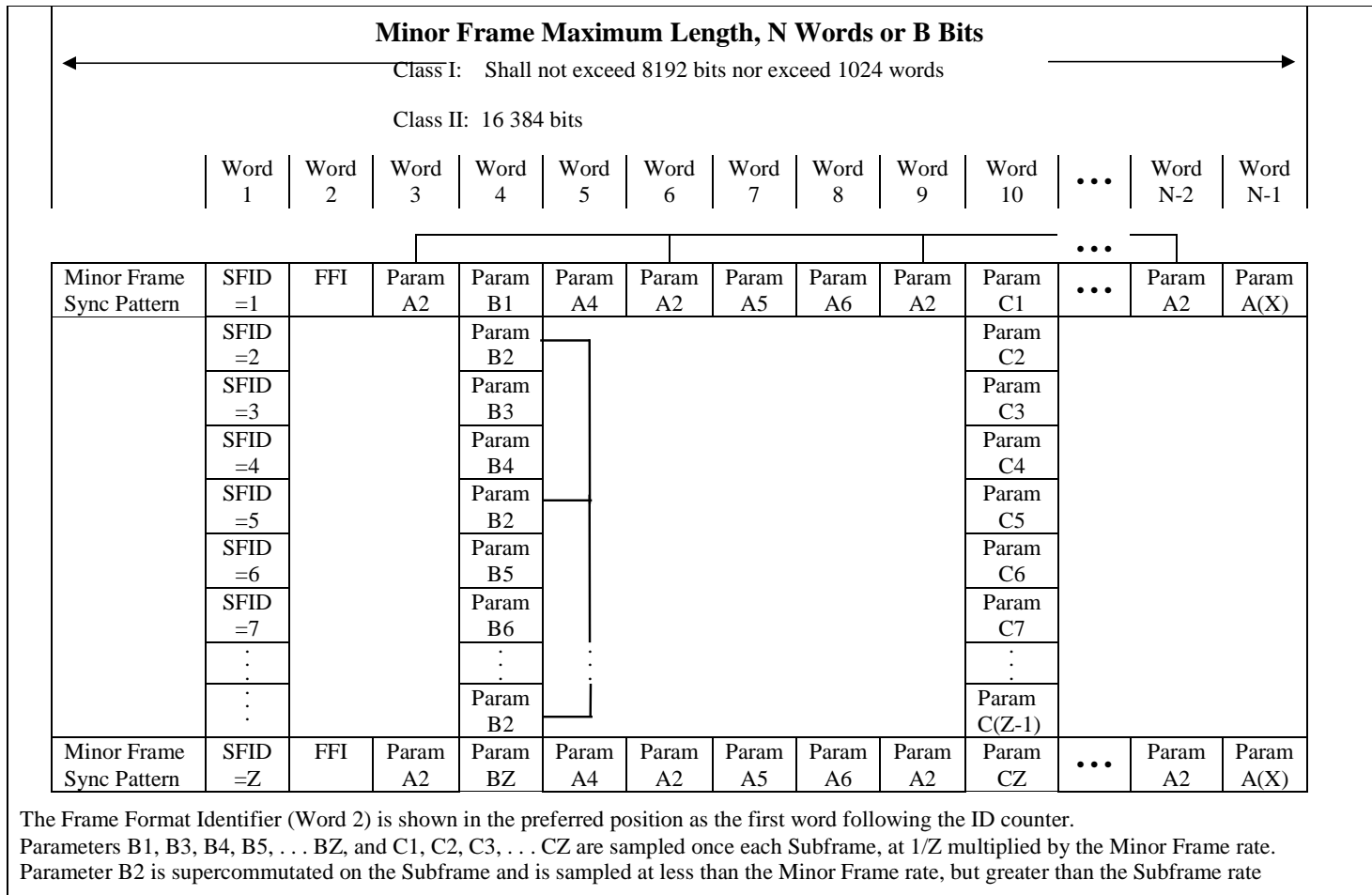

Figure C-5. Major Frame Length = Minor Frame Maximum Length multiplied by Z.

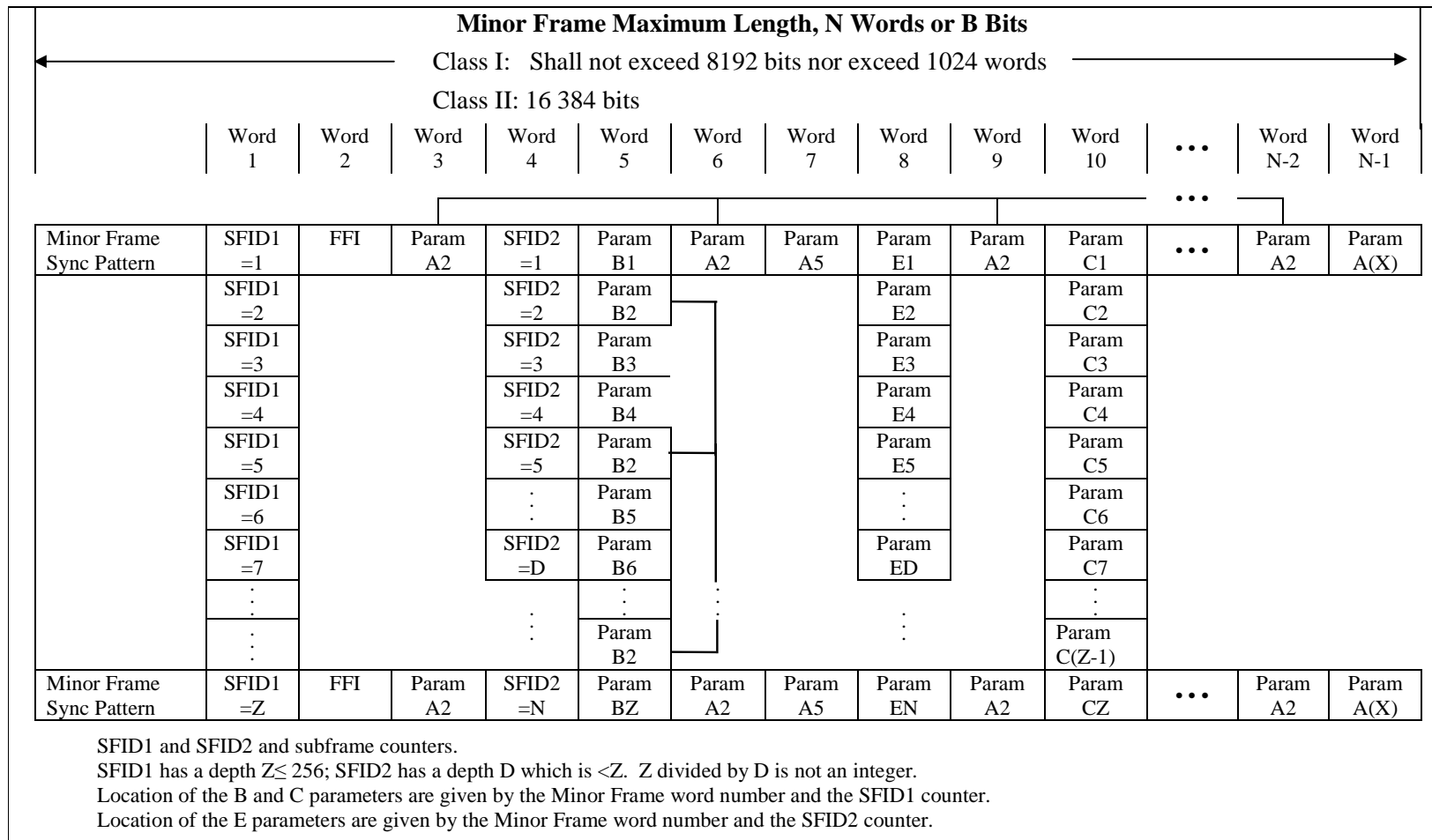

Figure C-6. Major Frame Length = Minor Frame Maximum Length multiplied by Z.

## APPENDIX D

### MAGNETIC TAPE RECORDER AND REPRODUCER INFORMATION AND USE CRITERIA

#### 1.0 Other Instrumentation Magnetic Tape Recorder Standards

The X3B6 Committee of the American National Standards Institute and the International Standards Organizations have prepared several standards for instrumentation magnetic tape recording. Documents may be obtained by contacting the American National Standards Institute (<http://webstore.ansi.org>).

1.1 Documentation Applicable to this Appendix is shown in the following subparagraphs.

1.1.1 ISO 1860 (1986), *Information Processing - Precision reels for magnetic tape used in interchange instrumentation applications.*

1.1.2 ISO 6068 (1985), *Information Processing - Recording characteristics of instrumentation magnetic tape (including telemetry systems) - interchange requirements.*

1.1.3 ISO/IEC TR 6371:1989, *Information Processing - Interchange practices and test methods for unrecorded instrumentation magnetic tape.*

1.1.4 ISO/IEC 8441/1:1991, *Information technology -- High Density Digital Recording (HDDR) - Part 1: Unrecorded magnetic tape for HDDR applications.*

1.1.5 ISO/IEC 8441/2:1991, *Information technology -- High Density Digital Recording (HDDR) - Part 2: Guide for interchange practice.*

1.1.6 ANSI INCITS 175-1999, *19 mm Type ID-1 Recorded Instrumentation -- Digital Cassette Tape Format* (formerly ANSI X3.175-1990).

#### 2.0 Double-Density Longitudinal Recording

Wide band double-density analog recording standards allowing recording of up to 4 MHz signals at 3048 mm/s (120 in./s) are included in these standards. For interchange purposes, either narrow track widths 0.635 mm (25 mils) must be employed, or other special heads must be used. These requirements are necessary because of the difficulty in maintaining individual head-segment gap-azimuth alignment across a head close enough to keep each track's response within the  $\pm 2$ -dB variation allowed by the standards. Moreover, at the lower tape speeds employed in double-density recording, the 38-mm (1.5-in.) spacing employed in interlaced head assemblies results in interchannel time displacement variations between odd and even tracks that may be unacceptable for some applications. For those reasons, it was decided that a 14-track in-line configuration on 25.4-mm (1-in.) tape should be adopted as a standard. This configuration results in essentially the same format as head number one of the 28-track interlaced configuration in the standards.

2.1 The 14-track interlaced heads are not compatible with tapes produced on an in-line standard configuration, and if tapes must be interchanged, a cross-configuration dubbing may be required, or a change of head assemblies on the reproducing machine is necessary.

2.2 High energy magnetic tape is required for double-density systems. Such tapes are available but may require special testing for applications requiring a low number of dropouts per track.

2.2.1 Other Track Configurations. The previously referenced standards include configurations resulting in 7, 14, and 21 tracks in addition to the 14- and 28-track configurations listed in Chapter 6. The HDDR standards also reference an 84-track configuration on 50.8-mm (2-in.) tape. Figure [D-1](#) and Table [D-1](#) show the 7 track on 12.7-mm (1/2-in.) tape, Table [D-2](#) shows the 14 track on 12.7-mm (1/2-in.) tape, and Table [D-3](#) shows the 42 track on 25.4-mm (1-in.) tape configurations.

2.2.2 High-Density PCM Recording. High-density digital recording systems are available from most instrumentation recorder manufacturers. Such systems will record at linear packing densities of 33 000-bits-per-inch or more per track. Special systems are available for error detection and correction with overhead penalties depending on the type and the sophistication of the system employed. The HDDR documents listed in paragraph 2.0 of this appendix reference six different systems that have been produced; others are available.

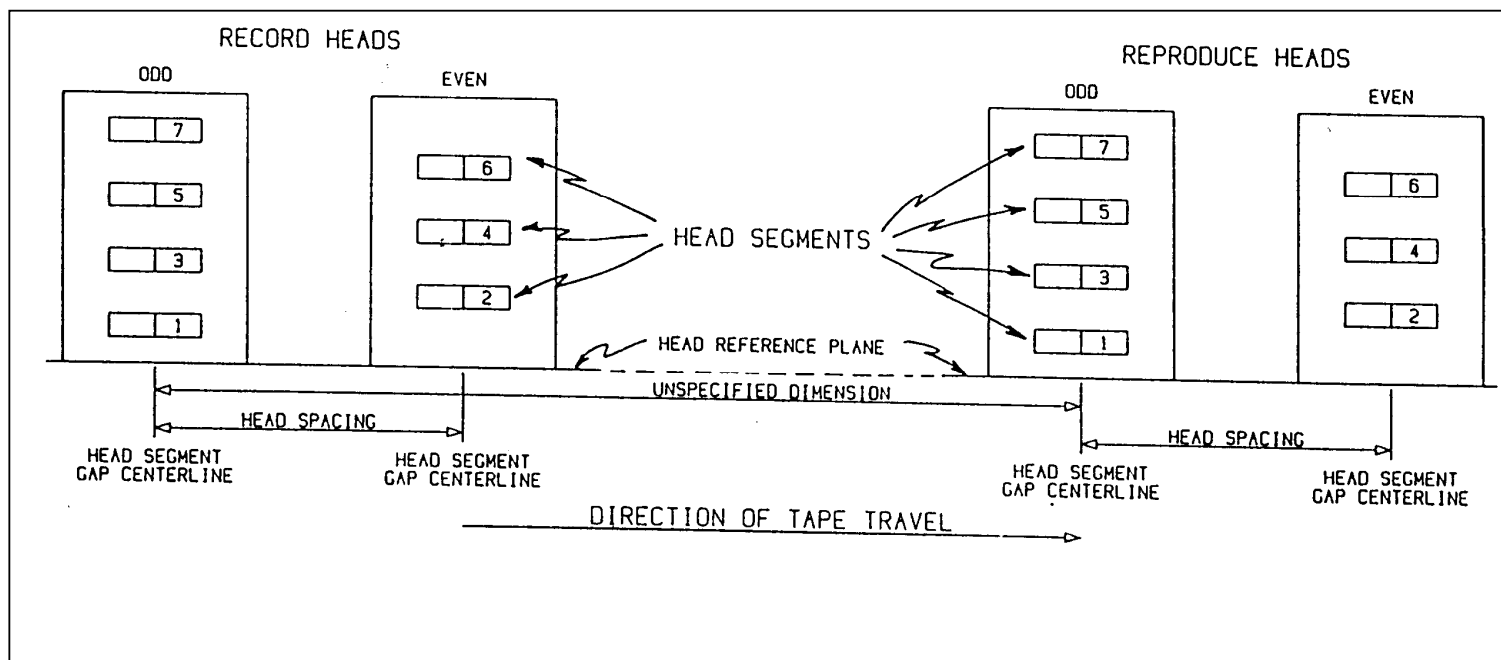

Figure D-1. Record and reproduce head and head segment identification and location (7-track interlaced system).

**TABLE D-1. DIMENSIONS - RECORDED TAPE FORMAT**  
**7 Tracks Interlaced on 12.7-mm (1/2 in.) Wide Tape**  
 (Refer to Figure 6-1)

Parameters	Millimeters		Inches
	<u>Maximum</u>	<u>Minimum</u>	
Track Width	1.397	1.143	0.050 ±0.005
Track Spacing		1.778	0.070
Head Spacing:			
Fixed Heads	38.125	38.075	1.500 ±0.001
Adjustable Heads	38.151	38.049	1.500 ±0.002
Edge Margin, Minimum		0.127	0.005
Reference Track			
Location	1.067	0.965	0.040 ±0.002
Track Location			
Tolerance	0.051	-0.051	±0.002
		<u>Location of nth track</u>	
<u>Track Number</u>	<u>Maximum</u>	<u>Minimum</u>	<u>Inches</u>
1 (Reference)	0.000	0.000	0.000
2	1.829	1.727	0.070
3	3.607	3.505	0.140
4	5.385	5.283	0.210
5	7.163	7.061	0.280
6	8.941	8.839	0.350
7	10.719	10.617	0.420



**TABLE D-2. DIMENSIONS - RECORDED TAPE FORMAT**  
**14 Tracks Interlaced on 12.7-mm (1/2 in.) Wide Tape**  
(Refer to Figure 6-1)

Parameters	Millimeters		Inches
	<u>Maximum</u>	<u>Minimum</u>	
Track Width	0.660	0.610	0.025 ±0.001
Track Spacing	0.889		0.035
Head Spacing:			
Fixed Heads	38.125	38.075	1.500 ±0.001
Adjustable Heads	38.151	38.049	1.500 ±0.002
Edge Margin, Minimum	0.127		0.005
Reference Track			
Location	0.546	0.470	0.0200 ±0.001
Track Location			
Tolerance	0.038	-0.038	±0.0015
	<u>Location of nth track</u>		
<u>Track Number</u>	<u>Millimeters</u>		<u>Inches</u>
	<u>Maximum</u>	<u>Minimum</u>	
1 (Reference)	0.000	0.000	0.000
2	0.927	0.851	0.035
3	1.816	1.740	0.070
4	2.705	2.629	0.105
5	3.594	3.518	0.140
6	4.483	4.407	0.175
7	5.372	5.292	0.210
8	6.261	6.185	0.245
9	7.150	7.074	0.280
10	8.039	7.963	0.315
11	8.928	8.852	0.350
12	9.817	9.741	0.385
13	10.706	10.630	0.420
14	11.595	11.519	0.455

**TABLE D-3. DIMENSIONS - RECORDED TAPE FORMAT**  
**42 Tracks Interlaced on 25.4-mm (1-in.) Wide Tape**  
(Refer to Figure 6-1)

Parameters	Millimeters		Inches
	<u>Maximum</u>	<u>Minimum</u>	
Track Width	0.483	0.432	0.018 ±0.001
Track Spacing	0.584		0.023
Head Spacing:			
Fixed Heads	38.125	38.075	1.500 ±0.001
Adjustable Heads	38.151	38.049	1.500 ±0.002
Edge Margin, Minimum	0.305		0.012
Reference Track			
Location	0.737	0.660	0.0275 ±0.015
Track Location			
Tolerance	0.025	-0.025	±0.0000
<u>Location of nth track</u>			
<u>Track Number</u>	<u>Millimeters</u>		<u>Inches</u>
	<u>Maximum</u>	<u>Minimum</u>	
1 (Reference)	0.000	0.000	0.000
2	0.610	0.559	0.023
3	1.194	1.143	0.046
4	1.778	1.727	0.069
5	2.362	2.311	0.092
6	2.946	2.896	0.115
7	3.531	3.480	0.138
8	4.115	4.064	0.161
9	4.699	4.648	0.184
10	5.283	5.232	0.207
11	5.867	5.817	0.230
12	6.452	6.401	0.253
13	7.036	6.985	0.276
14	7.620	7.569	0.299
15	8.204	8.153	0.322
16	8.788	8.738	0.345

(Continued on next page)

**TABLE D-3 (cont'd.) DIMENSIONS - RECORDED TAPE FORMAT**  
**42 Tracks Interlaced on 25.4-mm (1-in.) Wide Tape**  
 (Refer to Figure 6-1)

<u>Track Number</u>	<u>Location of nth track</u>		<u>Inches</u>
	<u>Millimeters</u>	<u>Millimeters</u>	
	<u>Maximum</u>	<u>Minimum</u>	
17	9.373	9.322	0.368
18	9.957	9.906	0.391
19	10.541	10.490	0.414
20	11.125	11.074	0.437
21	11.709	11.659	0.460
22	12.294	12.243	0.483
23	12.878	12.827	0.506
24	13.462	13.411	0.529
25	14.046	13.995	0.552
26	14.630	14.580	0.575
27	15.215	15.164	0.598
28	15.799	15.748	0.621
29	16.383	16.332	0.664
30	16.967	16.916	0.667
31	17.551	17.501	0.690
32	18.136	18.085	0.713
33	18.720	18.660	0.736
34	19.304	19.253	0.759
35	19.888	19.837	0.782
36	20.472	20.422	0.805
37	21.057	21.006	0.828
38	21.641	21.590	0.851
39	22.225	22.174	0.874
40	22.809	22.758	0.897
41	23.393	23.343	0.920
42	23.978	23.927	0.943

### 3.0 Serial HDDR

The following subparagraphs give some background for selecting the bi-phase and RNRZ-L systems specified in subparagraph [6.11.3](#), Chapter 6 of this document.

3.1 Serial HDDR is a method of recording digital data on a magnetic tape where the digital data is applied to one track of the recording system as a bi-level signal. The codes recommended for serial HDDR recording of telemetry data are Bi $\phi$ -L and randomized NRZ-L (RNRZ-L) (refer to paragraph [6.11](#), Chapter 6).

3.2 In preparing paragraph 6.11 of Chapter 6, the following codes were considered: Delay Modulation (Miller Code), Miller Squared, Enhanced NRZ, NRZ Level, NRZ Mark, and NRZ Space. These codes are not recommended for interchange applications at the bit rates given in paragraph 6.11.

3.3 The properties of the Bi $\phi$ -L and RNRZ-L codes relevant to serial HDDR and the methods for generating and decoding RNRZ-L are described next. Recording with bias is required for interchange applications, because reproduce amplifier phase and amplitude equalization adjustments for tapes recorded without bias usually differ from those required for tapes recorded with bias.

3.4 The Bi $\phi$ -L and RNRZ-L codes were selected for this standard because the "level" versions are easier to generate and are usually available as outputs from bit synchronizers. "Mark" and "Space" codes also have about twice as many errors as the level codes for the same SNR. If polarity insensitivity is a major consideration, agreement between interchange parties should be obtained before these codes are used.

3.5 Some characteristics of the Bi $\phi$ -L code favorable to serial HDDR are listed in the following subparagraphs.

3.5.1 Only a small proportion of the total signal energy occurs near dc.

3.5.2 The maximum time between transitions is a 1-bit period.

3.5.3 The symbols for one and zero are antipodal; that is, the symbols are exact opposites of each other. Therefore, the bit error probability versus SNR performance is optimum.

3.5.4 The Bi $\phi$ -L can be decoded using existing bit synchronizers.

3.5.5 The Bi $\phi$ -L is less sensitive to misadjustments of bias and reproducer equalizers than most other codes.

3.5.6 The Bi $\phi$ -L performs well at low tape speeds and low bit rates.

3.6 The most unfavorable characteristic of the Bi $\phi$ -L code is that it requires approximately twice the bandwidth of NRZ. Consequently, the maximum bit packing density that can be recorded on magnetic tape is relatively low.

3.7 Characteristics of the RNRZ-L code which favor its use for serial HDDR are included in the following subparagraphs.

3.7.1 The RNRZ-L requires approximately one-half the bandwidth of Bi $\phi$ -L.

3.7.2 The symbols for one and zero are antipodal; therefore, the bit error probability versus SNR performance is optimum.

3.7.3 The RNRZ-L decoder is self-synchronizing.

3.7.4 The RNRZ-L data can be bit synchronized and signal conditioned using existing bit synchronizers with the input code selector set to NRZ-L.

3.7.5 The RNRZ-L code is easily generated and decoded.

3.7.6 The RNRZ-L data can be easily decoded in the reverse mode of tape playback.

3.7.7 The RNRZ-L data are bit detected and decoded using a clock at the bit rate. Therefore, the phase margin is much larger than that of codes that require a clock at twice the bit rate for bit detection.

3.7.8 The RNRZ-L code does not require overhead bits.

3.8 Unfavorable characteristics of the RNRZ-L code for serial HDDR are described next.

3.8.1 Long runs of bits without a transition are possible although the probability of occurrence is low, and the maximum run length can be limited by providing transitions in each data word.

3.8.2 Each isolated bit error that occurs after the data has been randomized causes 3-bit errors in the derandomized output data.

3.8.3 The decoder requires 15 consecutive error-free bits to establish and reestablish error-free operation.

3.8.4 The RNRZ-L bit stream can have a large low frequency content. Consequently, reproducing data at tape speeds which produce PCM bit rates less than 200 kb/s is not recommended unless a bit synchronizer with specially designed dc and low frequency restoration circuitry is available.

### 3.9 Randomizer for RNRZ-L

The randomizer is implemented with a network of shift registers and modulo-2 adders (exclusive-OR gates). The RNRZ-L bit stream is generated by adding (modulo-2) the reconstructed NRZ-L PCM data to the modulo-2 sum of the outputs of the 14th and 15th stages of a shift register. The output RNRZ-L stream is also the input to the shift register (see Figure D-2).

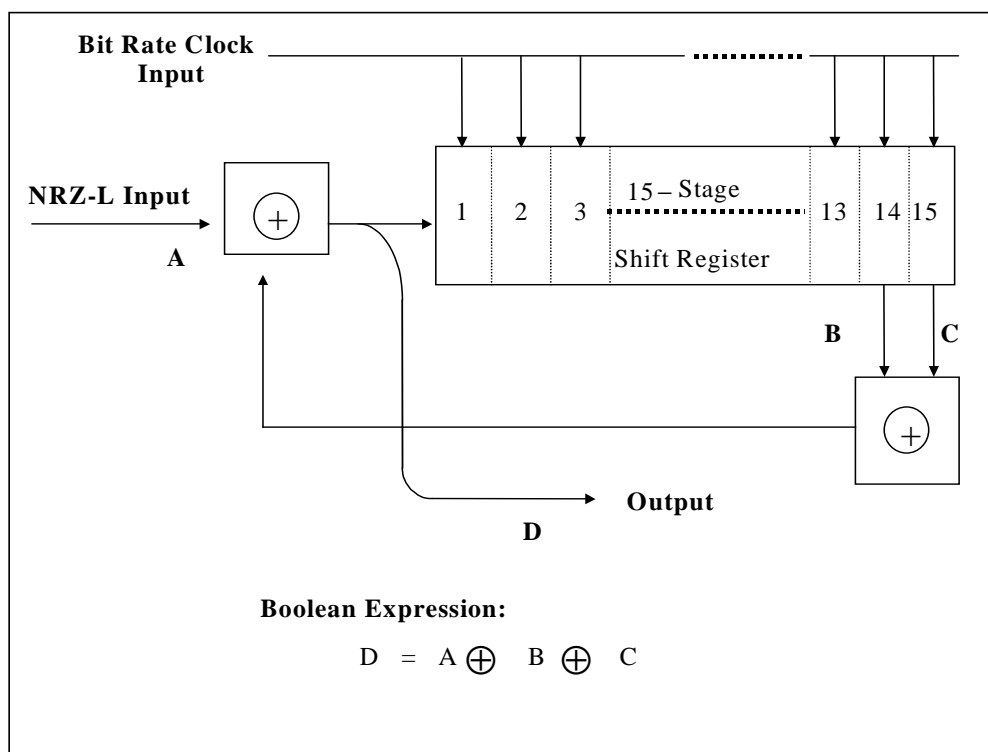

Figure D-2. Randomizer block diagram.

3.9.1 The properties of an RNRZ-L bit stream are similar to the properties of a pseudo-random sequence. A 15-stage RNRZ-L encoder will generate a maximal length pseudo-random sequence of  $2^{15}-1$  (32 767) bits if the input data consists only of zeros and there is at least a single one in the shift register. A maximal length pseudo-random sequence is also generated when the input data consists only of ones and the shift register contains at least a single zero. However, if the shift register contains all zeros at the moment that the input bit stream is all zeros, the RNRZ-L output bit stream will also be all zeros. The converse is also true: when the shift register is filled with ones and the input bit stream is all ones, the RNRZ-L output bit stream

will contain only ones. In these two cases, the contents of the shift register does not change and the output data is not randomized.

However, the randomizer is not permanently locked-up in this state because a change in the input data will again produce a randomized output. In general, if the input bit stream contains runs of  $X$  bits without a transition with a probability of occurrence of  $p(X)$ , the output will contain runs having a length of up to  $(X+15)$  bits with a probability of  $(2^{-15} \cdot p(X))$ . Therefore, the output can contain long runs of bits without a transition, but the probability of occurrence is low.

3.9.2 The RNRZ-L bit stream is decoded (derandomized) by adding (modulo-2) the reconstructed RNRZ-L bit stream to the modulo-2 sum of the outputs of the 14th and 15th stages of the shift register. The reconstructed RNRZ-L bit stream is the input to the shift register (see Figure D-3). The RNRZ-L data which is reproduced using the reverse playback mode of operation is decoded by adding (modulo-2) the reconstructed RNRZ-L bit stream to the modulo-2 sum of the outputs of the 1st and 15th stages of the shift register (see Figure D-3). The net effect is that the decoding shift register runs "backwards" with respect to the randomizing shift register.

3.9.3 Although the RNRZ-L decoder is self-synchronizing, 15 consecutive error-free bits must be loaded into the shift register before the output data will be valid. A bit slip will cause the decoder to lose synchronization, and 15 consecutive error-free data bits must again be loaded into the shift register before the output data is valid. The decoded output data, although correct, will contain the bit slip causing a shift in the data with respect to the frame synchronization pattern. Therefore, frame synchronization must be reacquired before the output provides meaningful data.

3.9.4 The RNRZ-L decoding system has an error multiplication factor of 3 for isolated bit errors (separated from adjacent bit errors by at least 15 bits). An isolated bit error introduced after randomization will produce 3 errors in the output data; the original bit in error, plus 2 additional errors 14 and 15 bits later. In addition, a burst of errors occurring after the data has been randomized will produce a burst of errors in the derandomized output. The number of errors in the output depends on the distribution of errors in the burst and can be greater than, equal to, or less than the number of errors in the input to the derandomizer. However, the derandomization process always increases the number of bits between the first and last error in the burst by 15. Errors introduced prior to randomization are not affected by either the randomizer or the derandomizer. The reverse decoder has the same bit error properties as the forward decoder.

3.9.5 Input data containing frequent long runs of bits without transitions creates potential dc and low frequency restoration problems in PCM bit synchronizers because of the low frequency cutoff of direct recorder and reproducer systems. The restoration problem can be minimized by reproducing the data at tape speeds that produce a bit rate for which the maximum time between transitions is less than 100 microseconds. Additional methods of minimizing these effects include selecting bit synchronizers containing special dc and low frequency restoration circuitry or recording data using Bi $\phi$ -L code.

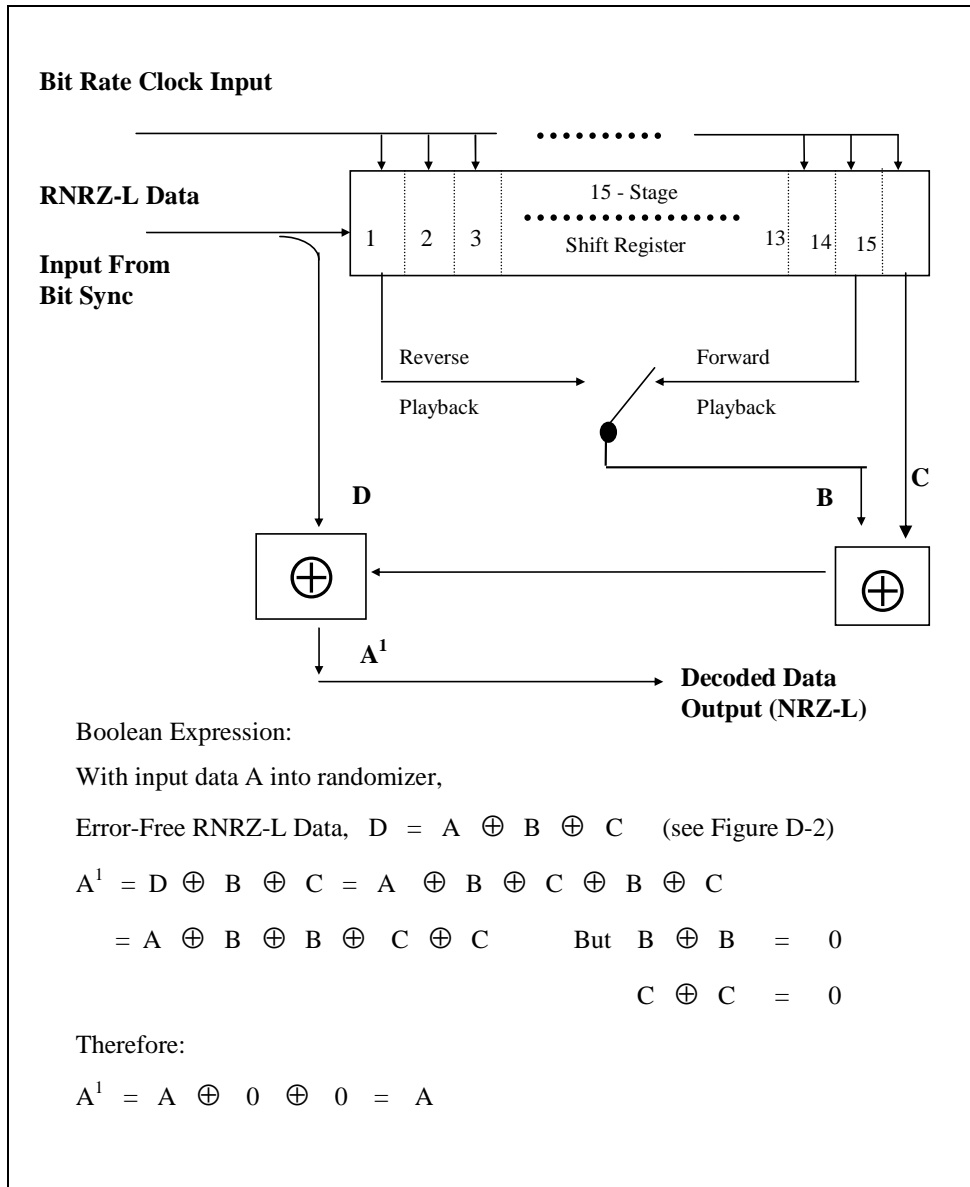

Figure D-3. Randomized NRZ-L decoder block diagram.



3.9.6 The power spectra of the RNRZ-L and Bi $\phi$ -L codes are shown in Figure D-4. The power spectral density of RNRZ-L is concentrated at frequencies, which are less than one-half the bit rate. The power spectral density of Bi $\phi$ -L is concentrated at frequencies in a region around 0.75 times the bit rate. The concentration of energy in the low-frequency region (when using the RNRZ-L code) has the effect of reducing the SNR as well as creating baseline wander, which the bit synchronizer must follow. Therefore, reproducing data at tape speeds which produce PCM bit rates of less than 200 kb/s is not recommended when using RNRZ-L unless a bit synchronizer with specially designed dc and low frequency restoration circuitry is available.

3.9.7 Alignment of the reproducer system is very important to reproducing high quality PCM data, that is, with the lowest possible bit error probability. A PCM signature using the standard 2047-bit pseudo-random pattern, recorded on the leader or the trailer tape, provides a good method for reproducer alignment. When a pseudo-random bit error detection system is not available or when a PCM signature signal is not recorded, the recommended procedure for reproducer alignment involves the use of the eye pattern technique. The eye pattern is the result of superpositioning the zeros and ones in the PCM bit stream. The eye pattern is displayed on an oscilloscope by inserting the raw reproduced bit stream into the vertical input and the reconstructed bit-rate clock into the external synchronization input of the oscilloscope. The reproducer head azimuth, amplitude equalizers, and phase equalizers are then adjusted to produce the eye pattern with the maximum height and width opening.

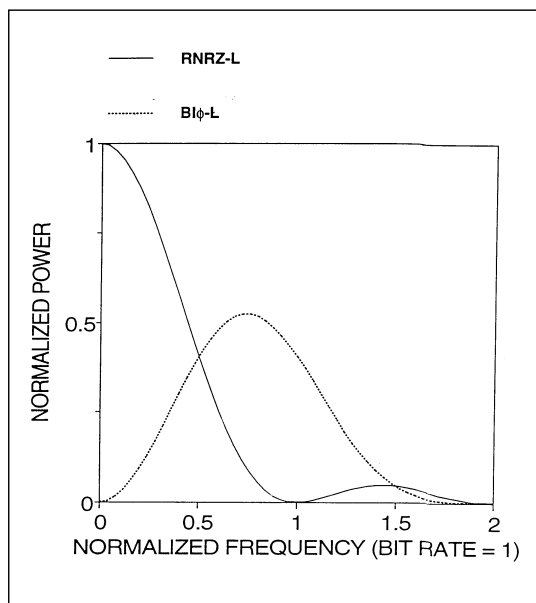

Figure D-4. Random PCM power spectra.

3.9.8 Sample eye patterns are shown in Figures [D-5a](#) and [D-5b](#). Figure D-5a shows a Bi $\phi$ -L eye pattern at a recorded bit packing density of 15 kb/in (450 kb/s at 30 in./s). Figure D-5b shows an RNRZ-L eye pattern at a recorded bit packing density of 25 kb/in (750 kb/s at 30 in./s).

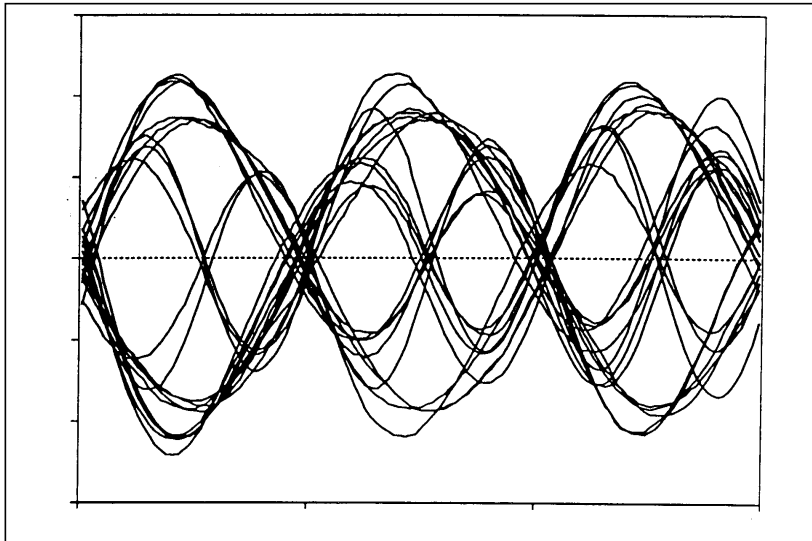

Figure D-5a. Bi $\phi$ -L at bit packing density of 15 kb/in.

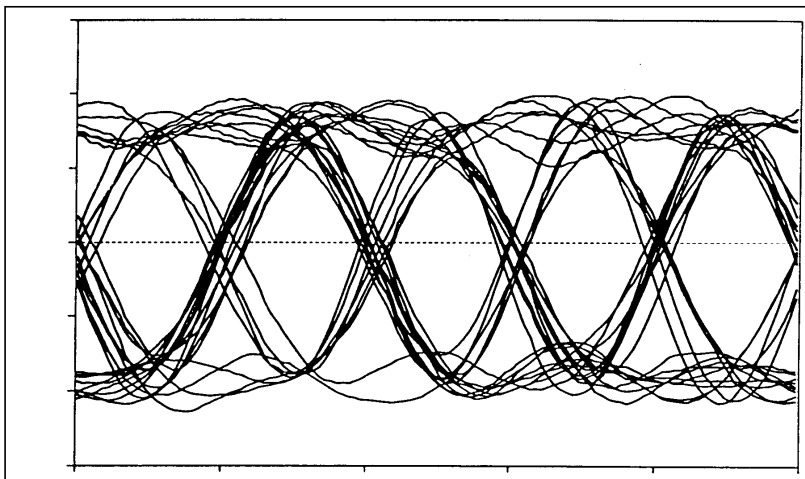

Figure D-5b. RNRZ-L at bit packing density of 25 kb/in.

## 4.0 Head Parameters

The following subparagraphs describe the head parameters.

4.1 Gap Scatter. Refer to the definitions in subparagraphs [6.2](#) in Chapter 6. Gap scatter contains components of azimuth misalignment and deviations from the average line defining the azimuth. Since both components affect data simultaneity from record to reproduce, the measurement is the inclusive distance containing the combined errors. Because azimuth adjustment affects the output of wide band systems, a 5.08- $\mu\text{m}$  (0.0002-in.) gap scatter is allowed for such recorders and reproducers. A 2.54- $\mu\text{m}$  (0.0001-in.) gap scatter is recommended for fixed-head systems (see upper illustration in Figure 6-3).

4.2 Head Polarity. The requirement that a positive pulse at a record amplifier input generate a south-north-north-south magnetic sequence and that a south-north-north-south magnetic sequence on tape produce a positive pulse at the reproduce amplifier output, still leaves two interdependent parameters unspecified. These parameters are (1) polarity inversion or noninversion in record and playback amplifiers and (2) record or playback head winding sense. For the purpose of head replacement, it is necessary that these parameters be determined by the user so that an unsuspected polarity inversion, on tape or off tape, will not occur after heads are replaced.

## 5.0 Record Level

The standard record level is established as the input level of a sinusoidal signal set at the record level set frequency which, when recorded, produces a signal containing 1 percent third harmonic distortion at the output of a properly terminated reproduce amplifier (see subparagraph 5.3.8.1 of Volume III, RCC Document 118). A 1 percent harmonic distortion content is achieved when the level of the third harmonic component of the record level set frequency is  $40 \pm 1$  dB below the level of a sinusoidal signal of 0.3 UBE which is recorded at the standard record level. Standard test and operating practice is to record and reproduce sinusoidal signals at 0.1 and 0.3 UBE and adjust the equalizers as necessary to establish the reproduced output at 0.3 UBE to within  $\pm 1.0$  dB of the output at 0.1 UBE. Then a 1-V rms signal at the record level set frequency is applied to the record amplifier input and the record and reproduce level controls are adjusted until the reproduced output contains 1 percent third harmonic distortion at a level of 1 V rms.

The optimum level for recording data will seldom be equal to the standard record level. Signals having noise-like spectral distribution such as baseband multiplexes of FM subcarriers contain high crest factors so that it may be necessary (as determined in paragraph 1.1, Noise Power Ratio (NPR) Test, Volume IV, RCC Document 118, *Test Methods for Data Multiplex Equipment*) to record at levels below the standard record level. On the other hand, for predetection and HDDR recording, signals may have to be recorded above the standard record level to give optimum performance in the data system.

## 6.0 Tape Crossplay Considerations

Figure [D-6](#) illustrates the typical departure from optimum frequency response that may result when crossplaying wide band tapes which were recorded with heads employing different record-head gap lengths. Line AA is the idealized output-versus-frequency plot of a machine with record bias and record level, set upper IRIG standards, using a 3.05- $\mu\text{m}$  (120-microinch) record-head gap length and a 1.02- $\mu\text{m}$  (40-microinch) reproduce-head gap length. Lines BB and CC represent the output response curves of the same tapes recorded on machines with 5.08- $\mu\text{m}$  (200-microinch) and 1.27- $\mu\text{m}$  (50-microinch) record-head gap lengths. Each of these recorders was set up individually per IRIG requirements. The tapes were then reproduced on the machine having a 1.02- $\mu\text{m}$  (40-microinch) reproduce-head gap length without readjusting its reproduce equalization.

6.1 The output curves have been normalized to 0 dB at the 0.1 UBE frequency for the purpose of clarity. The normalized curves may be expected to exhibit a  $\pm 2.0$  dB variance in relative output over the passband. The tape recorded with the shortest head segment gap length will provide the greatest relative output at the UBE.

6.2 While the examples shown are from older equipment with record gap lengths outside the limits recommended in subparagraph [6.5.4](#), Chapter 6, they illustrate the importance of the record gap length in tape interchange applications.

## 7.0 Standard Tape Signature Procedures

The following subparagraphs describe the PCM signature and the swept-frequency signature.

7.1 PCM Signature Recording Procedures. Configure test equipment as described in paragraph 2.1, Volume IV, RCC Document 118. The configuration should simulate the operational link as closely as possible, for example, same RF frequency, deviation, bit rate, code type, predetection frequency, receiver bandwidth, and recorder speed.

7.1.1 While recording the pseudo-random data at standard record level, adjust the signal generator output level until approximately one error per  $10^5$  bits is obtained on the error counter.

7.1.2 Record 30 seconds of the pseudo-random data at the beginning or end of the tape for each data track. A separate 30-second tape signature is recommended for each different data format.

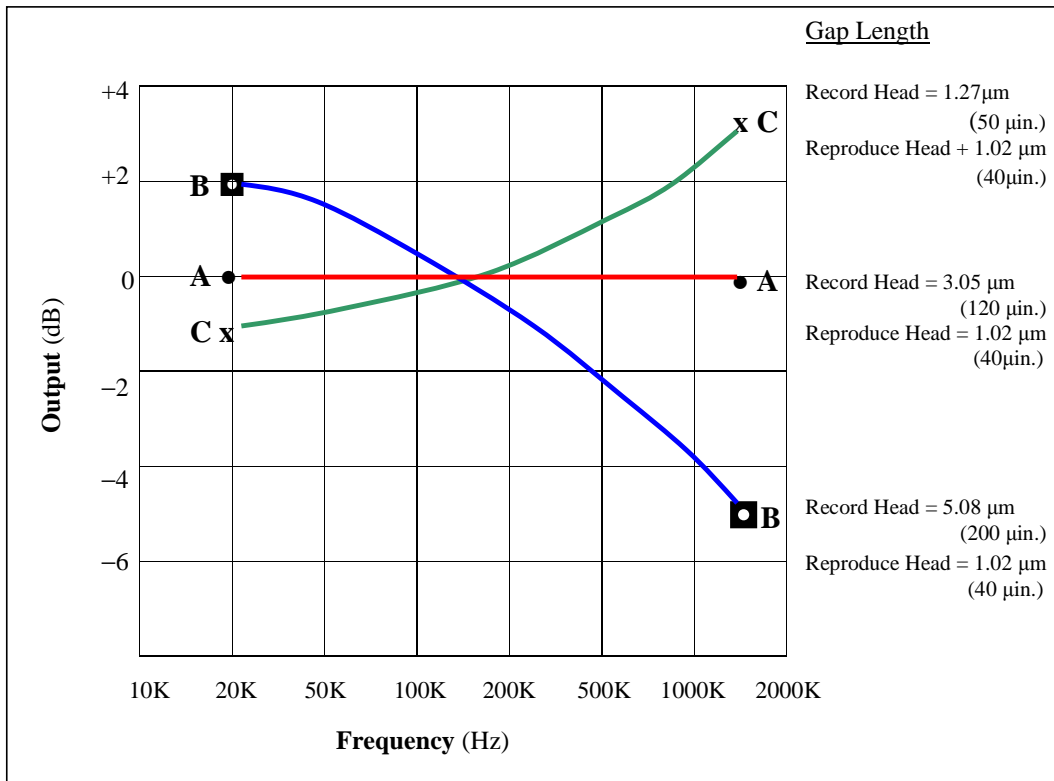

Figure D-6. Tape crossplay.

7.1.3 The content, track assignments, and location on the tape leader and trailer of signature signals should be noted on the tape label.

7.2 PCM Signature Playback Procedure. The following subparagraphs explain the playback procedure.

7.2.1 Optimize playback equipment such as receiver tuning and bit synchronizer setup for data being reproduced.

7.2.2 Reproduce the tape signature and observe the error rate on the error counter.

7.2.3 Optimize head azimuth for maximum signal output and minimum errors.

7.2.4 If more than one error per  $10^4$  bits is obtained, initiate corrective action.

7.2.5 Repeat for each data track.

7.3 Swept Frequency Signature Recording Procedure. The following subparagraphs describe the recording procedure for the swept-frequency signature.

7.3.1 Patch a sweep-frequency oscillator output to all prime data tracks (up to 6 on 7-track recorders or up to 13 on 14-track recorders) (see Appendix A, Volume III of RCC Document 118). As a minimum, patch the sweep oscillator to one odd and one even track.

7.3.2 Connect the sync output of the sweep oscillator to a track not used for sweep signals, preferably an outside track.

7.3.3 Record the signature signals for a minimum of 30 seconds at standard record level.



Record levels may be either preadjusted or quickly adjusted in all tracks during the first few seconds of the signature recording.

7.3.4 The content, track assignments, and location on the leader or trailer tape of signature signals should be noted on the tape label.

7.4 Swept-Frequency Signature Playback Procedure. The following subparagraphs define the steps for the playback procedure.

7.4.1 Connect the sync track output of the reproducer to the sync input of the scope.

7.4.2 Select an odd-numbered sweep-signal track and connect the output of the reproducer to the vertical input of the scope. Playback the sweep signal and adjust the scope gain for an amplitude of approximately  $\pm 10$  minor vertical divisions about the center baseline. Adjust the odd-track azimuth for maximum amplitude of the highest frequency segment (extreme right of the sweep pattern).

7.4.3 Observe amplitude variations through the sweep pattern and adjust the equalization, if necessary, to maintain the amplitude within the required tolerance over the required frequency range.



A decrease of sweep signal amplitude to about 0.7 represents a 3-dB loss.

7.4.4 Repeat the playback procedure in subparagraphs 7.4.2 and 7.4.3 for azimuth and equalization adjustments of an even-numbered tape track.

7.4.5 Repeat the procedure in subparagraph 7.4.3 for equalization only of other selected prime data tracks, as required.

## **8.0 Equipment Required for Swept-Frequency Procedures**

Equipment required at the recording site consists of a sweep-frequency oscillator having a constant amplitude sweep range of approximately 400 Hz through 4.4 MHz with frequency markers at 62.5, 125, 250, and 500 kHz and 1.0, 2.0, and 4.0 MHz. The sweep range to 4.4 MHz may be used for all tape speeds because the bandwidth of the recorder and reproducer will attenuate those signal frequencies beyond its range. The sweep rate should be approximately 25 Hz. Care should be exercised in the installation of the sweep generator to ensure a flat response of the sweep signal at the input terminals of the recorder. Appropriate line-driver amplifiers may be required for long cable runs or the low impedance of paralleled inputs.

8.1 A stepped-frequency oscillator could be substituted for the sweep-frequency generator at the recording location. Recommended oscillator wavelengths at the mission tape speed are 7.62 mm (300 mils), 3.81 mm (150 mils), 0.254 mm (10 mils), 0.0254 mm (1 mil), 0.0127 mm (0.5 mil), 0.0064 mm (0.25 mil), 0.0032 mm (0.125 mil), 0.0025 mm (0.1 mil), 0.0020 mm (0.08 mil), and 0.0015 mm (0.06 mil).

8.2 Equipment required at the playback site consists of an ordinary oscilloscope having a flat frequency response from 400 Hz through 4.4 MHz.

## **9.0 Fixed-Frequency Plus White Noise Procedure**

The signature used in this method is the same for all applications. For direct recording of subcarrier multiplexes, only static nonlinearity (nonlinearity which is independent of frequency) is important for crosstalk control. Subparagraph [6.8.2](#) in Chapter 6 provides a reference level for static nonlinearity. All formats of data recording are sensitive to SNR. Predetection recording and HDDR are sensitive to equalization. The following signature procedure satisfies all the above requirements.

9.1 Record a sine-wave frequency of 0.1 UBE (see Table [6-3](#)) with the following amplitudes.

9.1.1 Equal to the standard record level for direct recording of subcarrier multiplexes and HDDR (see subparagraph [6.8.2](#), Chapter 6).

9.1.2 Equal to the carrier amplitude to be recorded for pre-detection recording of PCM/FM, PCM/PM, FM/FM, and PAM/FM.

9.2 Record flat band-limited white noise of amplitude 0.7 of the true rms value of the 0-dB standard record level as described in subparagraph [6.8.2](#), Chapter 6. Noise must be limited by a low-pass filter just above the UBE.

9.3 Record with zero input (input terminated in 75 ohms). The three record steps previously described can consist of 10 seconds each. The spectra can be obtained with three manually initiated sweeps of less than a second each, because no great frequency resolution is required. All of the spectrum analyzer parameters can be standardized and set in prior to running the mission tape.

## **10.0 Signature Playback and Analysis**

Before analyzing the signature, the reproducer azimuth should be adjusted. With the short signature, it is probably more convenient to use the data part of the recording for this purpose. If predetection recording is used, the azimuth can be adjusted to maximize the output as observed on the spectrum analyzer or on a voltmeter connected to the output. If baseband recording is used, the azimuth can be adjusted to maximize the spectrum at the upper end of the band. Using a spectrum analyzer, reproduce, store, and photograph the spectra obtained from paragraphs 9.1, 9.2, and 9.3 in this appendix. Store and photograph the spectrum analyzer input level of zero.

10.1 It is evident that any maladjustment of the recorder and reproducer or magnetization of the heads will result in the decrease of SNR across the band and will be seen from the stored spectra or photograph.

10.2 By having a photograph of the spectra, amplitude equalization can be accomplished without shuttling the mission tape as follows.

10.2.1 Use an auxiliary tape (not the mission tape, but preferably the same type tape). With a white-noise input signal band limited, adjust the amplitude equalization of the recorder and reproducer at the tape dubbing or data reduction site and photograph the output spectrum (see paragraph 9.0 of this appendix).

10.2.2 Compare this photo with the photo made from the signature. Note the difference at several points across the band.

10.2.3 Using the auxiliary tape, adjust the amplitude equalization to compensate for the differences noted.

10.2.4 Recheck with the mission tape to verify that the desired amplitude equalization has been achieved.

10.3 If the phase equalization is to be checked, a square wave signal can be added to the signature in accordance with the manufacturer's specification (see Volume III, RCC Document 118). The same procedure as that recommended for amplitude equalization can be used, except based on oscillograms.



## 11.0 Recording and Playback Alignment Procedures

When using standard preamble (or postamble), see paragraph [6.12](#), Chapter 6.

### 11.1 Recording of Preamble for Direct Electronics Alignment

11.1.1 Patch a square wave generator output set to 1/11 band edge to all tracks having direct electronics or initiate procedure for recording internally generated 1/11 band edge square wave according to manufacturer's instructions.

11.1.2 If the preamble will be used for a manual adjustment, record for a minimum of 30 seconds at the standard record level and tape speed to be used for data recording.

11.1.3 If the preamble will be used only for automatic alignment, record at the standard record level and tape speed to be used for data recording for a sufficient time as specified by the manufacturer of the playback recorder reproducer or as agreed by the interchange parties.

11.2 Playback of Preamble for Direct Electronics Alignment. For systems so equipped, initiate automatic alignment procedure per manufacturer's instructions. The procedure for manual adjustment is described in the following subparagraphs.

11.2.1 Display fundamental and odd harmonics of the square wave (third through eleventh) of selected odd numbered direct track near center of head stack on the spectrum analyzer. Adjust azimuth by peaking output amplitude of the third through eleventh harmonic. Final adjustment should peak the eleventh harmonic.

11.2.2 Repeat the above subparagraph for even numbered direct track. (Only one track is necessary for double density, 14-track, in-line system.)

11.2.3 Observe frequency response across the band pass on selected track and correct if necessary. For a flat response, the third harmonic will be 1/3 of the amplitude of the fundamental, fifth harmonic 1/5 the amplitude, and so on. A convenient method is to compare the recorder/reproducer output with that of a square wave generator patched directly to the spectrum analyzer.



An alternate, but less accurate, method is to optimize the square wave as displayed on an oscilloscope rather than a spectrum analyzer.

11.2.4 Repeat the previous subparagraph for each direct track.

11.2.5 Display square wave on oscilloscope. Adjust phase for best square wave response as shown in Figure D-7.

11.2.6 Repeat the previous subparagraph for each direct track.

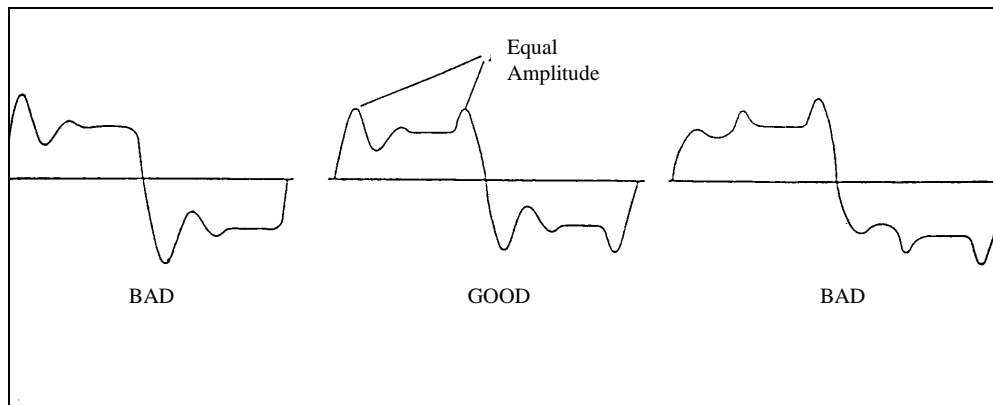

Figure D-7. Square wave responses.

11.3 Recording of Preamble for FM Electronics Alignment. If available, initiate procedure for recording internally generated 1/11 band edge square wave and  $\pm 1.414$  Vdc per manufacturer's instructions. Otherwise, patch a square wave generator output to all tracks having FM electronics. A near dc signal may be obtained by setting the square wave generator to 0.05 Hz and  $\pm 1.414$  V or by using a separate dc source.

11.3.1 If the preamble will be used for manual alignment, record at least one cycle of the 0.05 Hz square wave at  $\pm 1.414$  V or a positive and negative 1.414 Vdc for a minimum of 10 seconds each at the tape speed to be used for data recording. Next, record a 1/11 band edge square wave for a minimum of 20 seconds.

11.3.2 If the preamble will be used only for automatic alignment, record the above sequence for a sufficient time as specified by the manufacturer of the playback recorder/reproducer or as agreed by the interchange parties.

11.4 Playback of Preamble for FM Electronics Alignment. For systems so equipped, initiate automatic alignment procedure per manufacturer's instructions. The procedure for manual adjustment is described in the next subparagraphs.

11.4.1 Check and adjust for 0-V output at center frequency per RCC Document 118, *Test Methods for Telemetry Systems and Subsystems*, Volume III, Test Methods for Recorder/Reproducer Systems and Magnetic Tape.

11.4.2 Use dc voltmeter to verify a full positive and negative output voltage on the selected track and correct if necessary.

11.4.3 Display fundamental and odd harmonics of the square wave (third through eleventh) on the spectrum analyzer.

11.4.4 Observe frequency response per subparagraph 11.2.3.

11.4.5 Repeat subparagraphs 11.4.1 through 11.4.3 for each FM track.

This page intentionally left blank.

**APPENDIX E DELETED**

**AVAILABLE TRANSDUCER DOCUMENTATION**

**(This Appendix Has Been Intentionally Deleted)**

This page intentionally left blank.

## APPENDIX F

### CONTINUOUSLY VARIABLE SLOPE DELTA MODULATION

#### 1.0 General

The continuously variable slope delta (CVSD) modulation is a nonlinear, sampled data, feedback system which accepts a band-limited analog signal and encodes it into binary form for transmission through a digital channel. At the receiver, the binary signal is decoded into a close approximation of the original analog signal. A typical CVSD converter consisting of an encoder and decoder is shown in Figures [F-1a](#) and [F-1b](#).

#### 2.0 General Descriptions

A general description of the delta modulation and the CVSD converter can be found in the succeeding subparagraphs.

2.1 Delta Modulation. Delta modulation is an A-D conversion technique resulting in a form of digital pulse modulation. A delta modulator periodically samples the amplitude of a band-limited analog signal, and the amplitude differences of two adjacent samples are coded into n-bit code words. This nonlinear, sampled-data, feedback system then transmits the encoded bit stream through a digital channel. At the receiving end, an integrating network converts the delta-modulated bit stream through a decoding process into a close approximation of the original analog signal.

2.1.2 CVSD Converter. A typical CVSD converter consists of an encoder and a decoder (see Figures [F-1a](#) and [b](#)). The analog input signal of the CVSD encoder is band-limited by the input band, pass filter. The CVSD encoder compares the band-limited analog input signal with an analog feedback approximation signal generated at the reconstruction integrator output. The digital output signal of the encoder is the output of the first register in the "run-of-three" counter. The digital output signal is transmitted at the clock (sample) rate and will equal "1" if the analog input signal is greater than or equal to the analog feedback signal at the instant of sampling. For this value of the digital output signal, the pulse amplitude modulator (PAM) applies a positive feedback pulse to the reconstruction integrator; otherwise, a negative pulse is applied. This function is accomplished by the polarity control signal, which is equal to the digital encoder output signal. The amplitude of the feedback pulse is derived by means of a 3-bit shift register, logic sensing for overload, and a syllabic lowpass filter. When a string of three consecutive ONES or ZEROS appears at the digital output, a discrete voltage level is applied to the syllabic filter, and the positive feedback pulse amplitude increases until the overload string is broken. In such an event, ground potential is fed to the filter by the overload algorithm, forcing a decrease in the amplitude of the slope voltage out of the syllabic filter. The encoder and decoder have identical characteristics except for the comparator and filter functions.

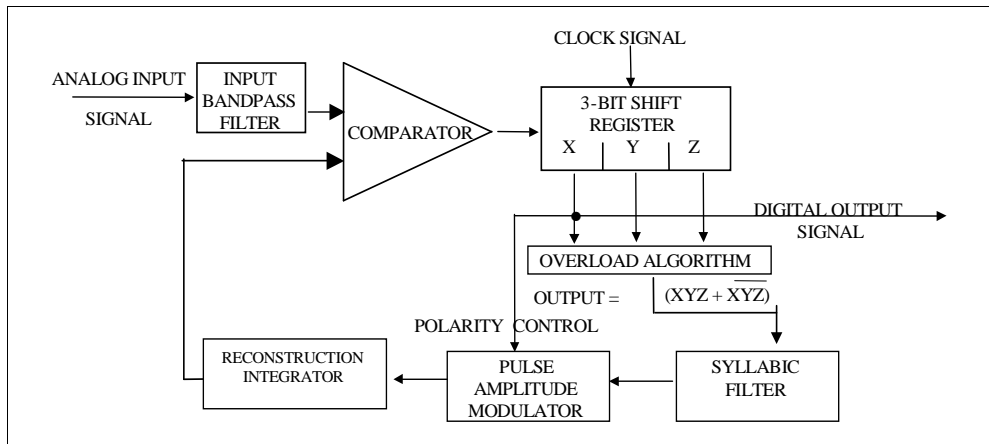

Figure F-1a. Typical CVSD encoder.

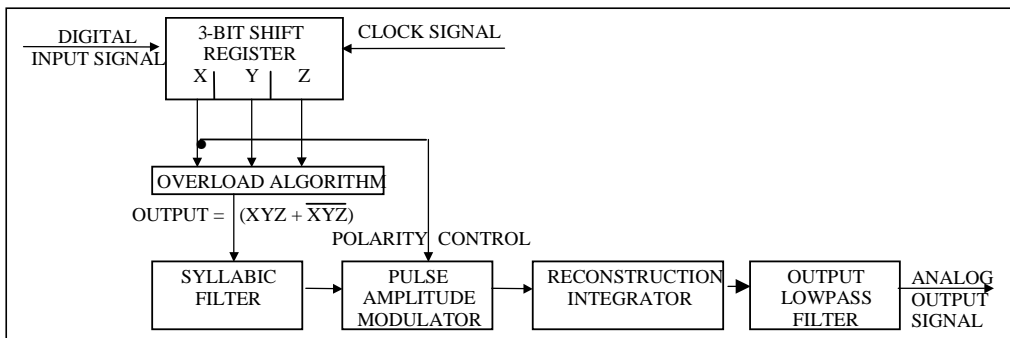

Figure F-1b. Typical CVSD decoder.

The CVSD decoder consists of the input band pass filter, shift register, overload algorithm, syllabic filter, PAM and reconstruction integrator used in the encoder, and an output low-pass filter. The decoder performs the inverse function of the encoder and regenerates speech by passing the analog output signal of the reconstruction integrator through the low-pass filter. Other characteristics optimize the CVSD modulation technique for voice signals. These characteristics include:



- a. Changes in the slope of the analog input signal determine the step-size changes of the digital output signal.
- b. The feedback loop is adaptive to the extent that the loop provides continuous or smoothly incremental changes in step size.
- c. Companding is performed at a syllabic rate to extend the dynamic range of the analog input signal.
- d. The reconstruction integrator is of the exponential (leaky) type to reduce the effects of digital errors.

### 3.0 Detailed Descriptions

The characteristics described in subparagraphs 3.1 through 3.9 are in addition to those specified in paragraph 5.0 of this standard and are for guidance only.

3.1 Input Band Pass Filter. The input filter provides band-limiting and is typically a second- or higher-order filter (see Figure F-1a).

3.2 Comparator. The comparator compares the band-limited analog input signal from the filter with the output signal of the reconstruction integrator (see Figure F-1a). This comparison produces the digital error signal input to the 3-bit shift register. The transfer characteristic of the comparator is such that the difference between the two input signals causes the output signal to be driven to saturation in the direction of the sign of the difference.

3.3 3-Bit Shift Register. The 3-bit shift register acts as a sampler which clocks the digital error signal from the comparator at the specified data signaling rate and stores the current samples and two previous samples of the error signal (see Figures F-1a and b). The digital output signal is a binary signal having the same polarity as the input signal from the comparator at the time of the clock signal. The digital output signal is also the digital output of the encoder and is referred to as the baseband signal. Further processing for transmission such as conditioned diphase modulation may be applied to the baseband signal. It is necessary that the inverse of any such processing be accomplished and the baseband signal restored before the CVSD decoding process is attempted.

3.4 Overload Algorithm. The overload algorithm operates on the output of the 3-bit shift register (X, Y, Z) using the run-of-threes coincidence algorithm so that the algorithm output equals  $(XYZ + \overline{XYZ})$  (see Figures F-1a and b). The output signal is a binary signal at the clock signaling rate and is true for one clock period following the detection of three like bits and false at all other times.

3.5 Syllabic Filter. The syllabic filter acts as a low-pass filter for the output signal from the overload algorithm (see Figures [F-1a](#) and [b](#)). The slope-voltage output of the syllabic filter is the modulating input to the PAM. The step-function response of the syllabic filter is related to the syllabic rate of speech, is independent of the sampling rate, and is exponential in nature. When the overload algorithm output is true, a charging curve is applicable. When this output is false, a discharging curve is applicable.

3.6 Pulse Amplitude Modulator (PAM). The PAM operates with two input signals: the output signal from the syllabic filter, and the digital signal from the 3-bit shift register (see Figures [F-1a](#) and [b](#)). The syllabic filter output signal determines the amplitude of the PAM output signal and the signal from the 3-bit shift register is the polarity control that determines the direction, plus or minus, of the PAM output signal. The phrase "continuously variable" in CVSD is derived from the way the PAM output signal varies almost continuously.

3.7 Reconstruction Integrator. The reconstruction integrator operates on the output signal of the PAM to produce an analog feedback signal to the comparator (or an output signal to the output low-pass filter in the receiver) that is an approximation of the analog input signal (see Figures [F-1a](#) and [b](#)).

3.8 Output Low-Pass Filter. The output filter is a low-pass filter having a frequency response that typically has an asymptotic rolloff with a minimum slope of 40 dB per octave, and a stopband rejection that is 45 dB or greater (see Figure [F-1b](#)). The same output filter characteristic is used for encoder digital output signals of either 16 or 32 kbps.

3.9 Typical CVSD Decoder Output Envelope Characteristics. For a resistance/ capacitance circuit in the syllabic filter with time constants of 5 ms for both charging and discharging, the envelope characteristics of the signal at the decoder output are shown in Figure [F-2](#). For the case of switching the signal at the decoder input from the 0-percent run-of-threes digital pattern to the 30-percent run-of-threes digital pattern, the characteristic of the decoder output signal follows the resistance/capacitance charge curve. Note that the number of time constants required to reach the 90-percent charge point is 2.3, which gives a nominal charge time of 11.5 ms.

When switching the other way (from the 30-percent pattern to the 0-percent pattern), the amplitude at the beginning of discharging is, at the first moment of switching, higher (by a factor of 16) than the final value which is reached asymptotically. The final value equals  $-24 \text{ dBm}_0$ , that is, 0.03. Therefore, the amplitude at the beginning of discharging is 0.48 (percent run-of-threes = 0). Note that the number of time constants required to reach the 10-percent point on the discharge curve is 1.57, which gives a nominal discharge time of 7.8 ms.

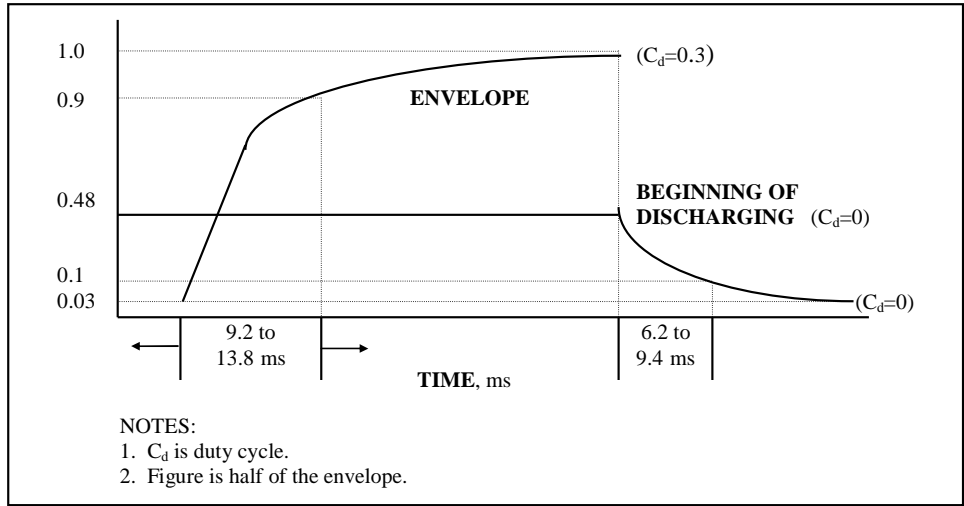

Figure F-2. Typical envelope characteristics of the decoder output signal for CVSD.

#### 4.0 Reference Level

The decoder analog output level with the 16 and 32 kbps, 30-percent run-of-threes reference digital pattern applied to the decoder input shall be the reference level for the CVSD requirements of this standard and shall be designated 0 dBm0 (see subparagraph 5.9.1).

#### 5.0 CVSD Characteristics

The characteristics of CVSD are described in the following subparagraphs.

5.1 Input and Output Impedances. The analog input and output impedances for CVSD converters are not standardized. These impedances depend upon the application of the converters.

5.2 Data Signaling Rates. The CVSD converter shall be capable of operating at 16 and 32 kbps.

5.3 Input and Output Filters. The analog input shall be band pass filtered. The analog output shall be low pass filtered.



Details of input and output filters, consistent with the CVSD performance requirements of this standard, will be determined in applicable equipment specifications based on validated requirements

5.4 Overload Algorithm. A 3-bit shift register shall be used for the CVSD encoder and decoder (see Figures [F-1a](#) and [b](#)). The overload logic shall operate on the output of this shift register using the run-of-threes coincidence algorithm. The algorithm output signal shall be a binary signal at the data-signaling rate. This signal shall be true for one clock period following the detection of three like bits (all ZEROS or all ONES) and false at all other times.

5.5 Compression Ratio. The compression ratio shall be nominally 16:1 with a maximum of 21:1 and a minimum of 12:1. The maximum slope voltage shall be measured at the output of the syllabic filter for a 30-percent run-of-threes digital pattern. The minimum slope voltage shall be measured at the output of the syllabic filter for a 0-percent run-of-threes digital pattern.

5.6 Syllabic Filter. The syllabic filter shall have a time constant of  $5\text{ ms} \pm 1$ . The step function response of the syllabic filter shall be exponential in nature. When the output of the overload algorithm is true, a charge curve shall be applicable. When the output of the overload algorithm is false, a discharge curve shall be applicable.

5.7 Reconstruction Integrator Time Constant. The reconstruction integrator shall have a time constant of  $1\text{ ms} \pm 0.25$ .

5.8 Analog-to-Digital Conversion. An 800-Hz  $\pm 10$  signal at a 0 dBm0 level applied to the input of the encoder shall give a duty cycle ( $C_d$ ) of 0.30 at the algorithm output of the encoder shown in Figure [F-1a](#).

5.9 Digital-to-Analog Conversion. The characteristics of a digital-to-analog conversion are described in the following subparagraphs.

5.9.1 Relation of Output to Input. With the applicable reference digital patterns of Table [F-1](#) applied to the digital input of the decoder as shown in Figure [F-3](#), the analog output signal shall be 800 Hz  $\pm 10$  at the levels shown in Table F-1, measured at the decoder output. These digital patterns, shown in hexadecimal form, shall be repeating sequences.

5.9.2 Conversion Speed. When the decoder input is switched from the 0-percent run-of-threes digital pattern to the 30-percent run-of-threes digital pattern, the decoder output shall reach 90 percent of its final value within 9 to 14 ms. When the decoder input is switched from the 30-percent run-of-threes digital pattern to the 0-percent run-of-threes digital pattern, the decoder output shall reach 10 percent of the 30-percent run-of-threes value within 6 to 9 ms. These values shall apply to both the 16 and 32-kbps data signaling rates.

5.10 CVSD Converter Performance. The characteristics specified in subparagraphs 5.10.1 through 5.10.7 apply to one CVSD conversion process obtained by connecting the output of an encoder to the input of a decoder (see Figure [F-3](#)).



Test signal frequencies that are submultiples of the data signaling rate shall be avoided by offsetting the nominal test frequency slightly; for example, an 800-Hz test frequency could be offset to 804 Hz. This test frequency offset will avoid nonlinear distortion, which can cause measurement difficulties when CVSD is in tandem with PCM.

**TABLE F-1. DECODER REFERENCE DIGITAL PATTERNS FOR CVSD**

Data Signaling Rate (kpbs)	Digital Pattern	Run-of-threes, (percent)	Output (dBm0)
16	DB492	0	-24±1
32	DB54924AB6	0	-24±1
16	FB412	30	0±1
32	FDAA10255E	30	0±1

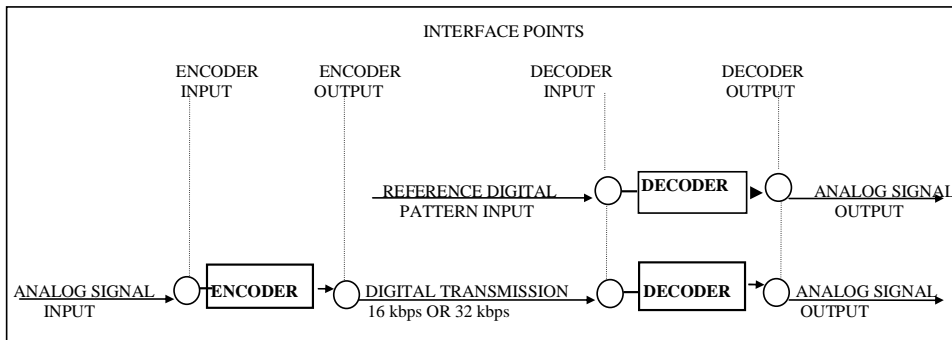

Figure F-3. Interface diagram for CVSD converter.

5.10.1 Companding Speed. When an 800-Hz  $\pm 10$  sine wave signal at the encoder input is switched from  $-24$  dBm0 to 0 dBm0, the decoder output signal shall reach 90 percent of its final value within 9 to 14 ms.

5.10.2 Insertion Loss. The insertion loss between the encoder input and the decoder output shall be 0 dB  $\pm 2$  dB with an 800 Hz  $\pm 10$ , 0 dBm0 input to the encoder.

5.10.3 Insertion Loss Versus Frequency Characteristics. The insertion loss between the encoder input and decoder output, relative to 800 Hz  $\pm 10$  measured with an input level of  $-15$  dBm0 applied to the converter input, shall not exceed the limits indicated in Table [F-2](#) and shown in Figures [F-4a](#) and [b](#).

<b>TABLE F-2. INSERTION LOSS LIMITS FOR CVSD</b>		
<b>Rate</b> (kpbs)	<b>Frequency (<i>f</i>)</b> (Hz)	<b>Insertion Loss (dB)</b> (Referenced to 800 Hz)
16	$f < 300$	$\geq -1.5$
	$300 \leq f < 1000$	$-1.5$ to $1.5$
	$1000 \leq f < 2600$	$-5$ to $1.5$
	$2600 \leq f < 4200$	$\geq -5$
	$4200 \leq f$	$\geq 25$
32	$f < 300$	$\geq -1$
	$300 \leq f < 1400$	$-1$ to $1$
	$1400 \leq f < 2600$	$3$ to $1$
	$2600 \leq f < 3400$	$3$ to $2$
	$3400 \leq f < 4200$	$\geq -3$
$4200 \leq f$	$\geq 25$	

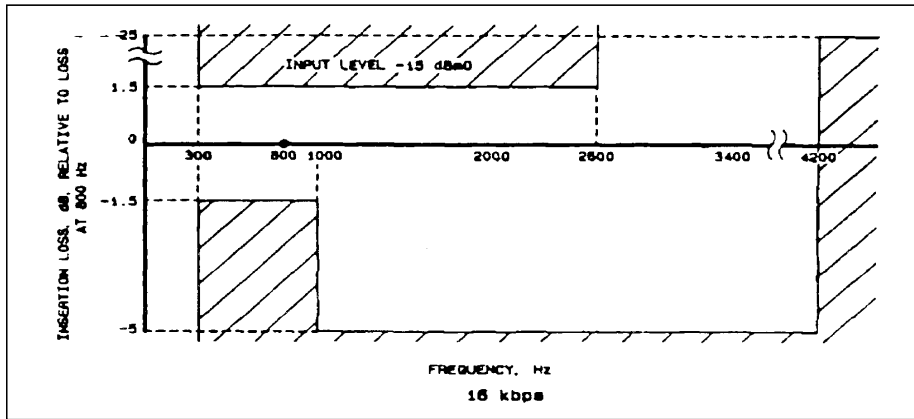
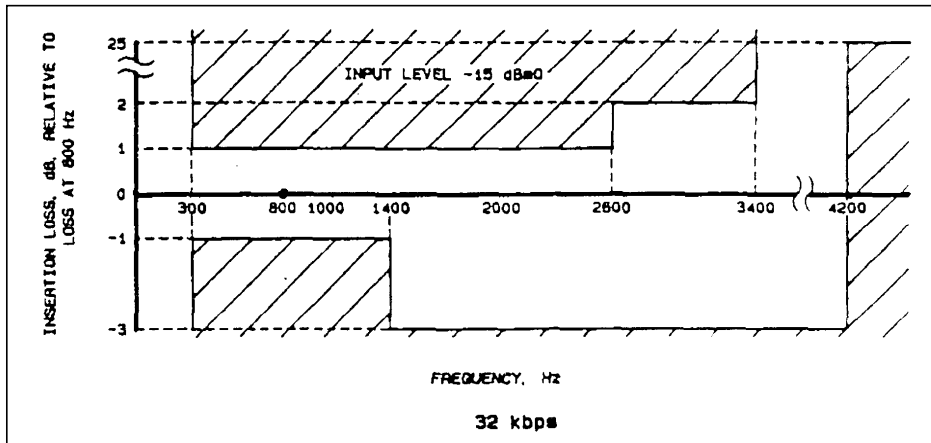

Figure F-4a. Insertion loss versus frequency for CVSD (16 kbps).

Figure F-4b. Insertion loss versus frequency for CVSD (32 kbps).



5.10.4 Variation of Gain With Input Level. The variation in output level, relative to the value at  $-15 \text{ dBm}_0$  input, shall be within the limits of Figure F-5a and b for an input frequency of  $800 \text{ Hz} \pm 10$ .

5.10.5 Idle Channel Noise. The idle channel noise shall not exceed the limits shown in Table F-3 when measured at the CVSD decoder output.

5.10.6 Variation of Quantizing Noise With Input Level. The minimum signal to quantizing noise ratio over the input signal level range shall be above the limits of Figure F-6a and b. The noise ratio shall be measured with flat weighting (unweighted) at the decoder output with a nominal  $800\text{-Hz} \pm 10$  sine wave test signal at the encoder input.

5.10.7 Variation of Quantizing Noise With Frequency. The minimum signal to quantizing noise ratio over the input frequency range shall be above the limits of Figure F-7a and b. The noise ratio shall be measured with flat weighting (unweighted) at the decoder output with a sine wave test signal of  $-15$  dBm0.

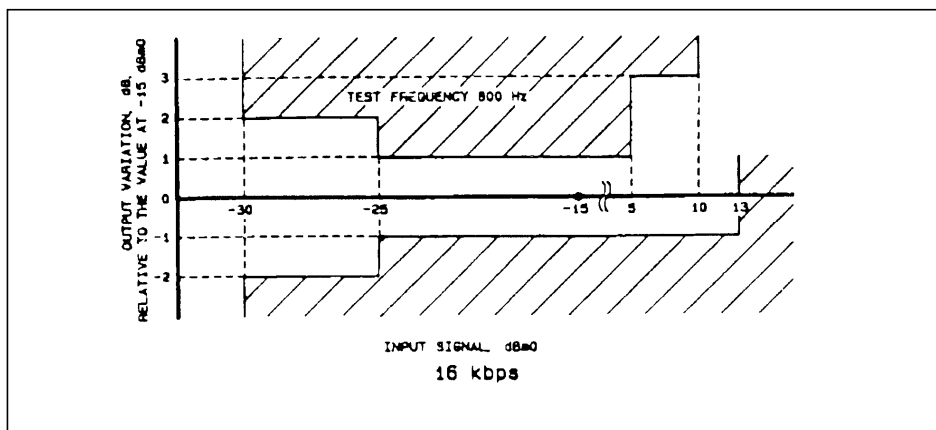

Figure F-5a. Variation of gain with input level for CVSD (16 kbps).

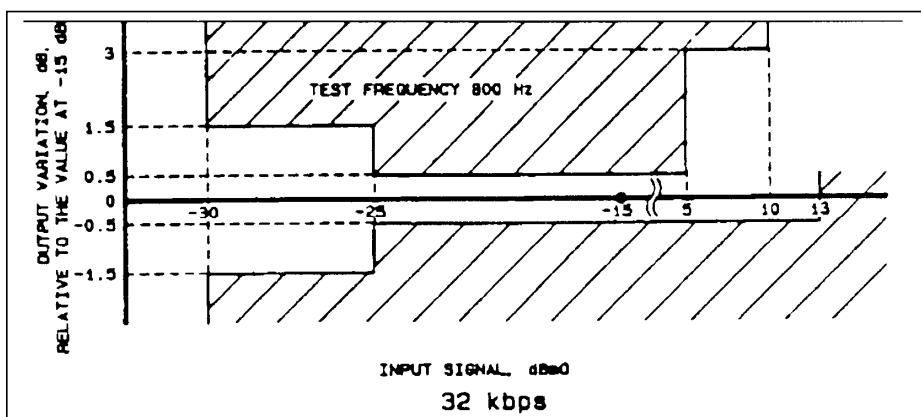

Figure F-5b. Variation of gain with input level for CVSD (32 kbps).



TABLE F-3. IDLE CHANNEL NOISE LIMITS FOR CVSD	
Data Signaling Rate (kbps)	Idle Channel Noise (dBm0)
16	-40
32	-50

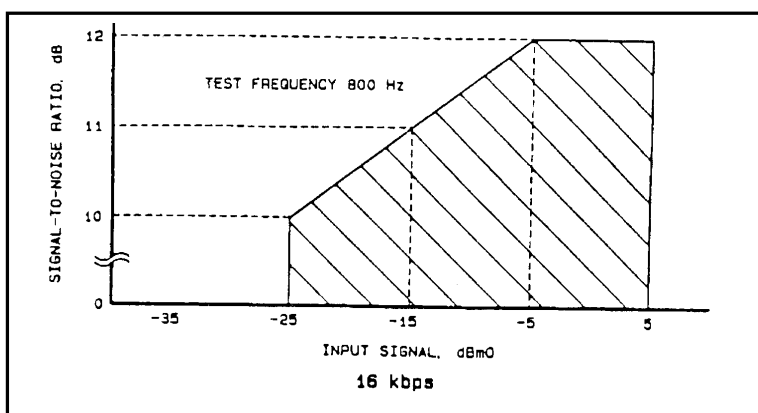

Figure F-6a. Signal to quantizing noise ratio vs input level for CVSD (16 kbps).

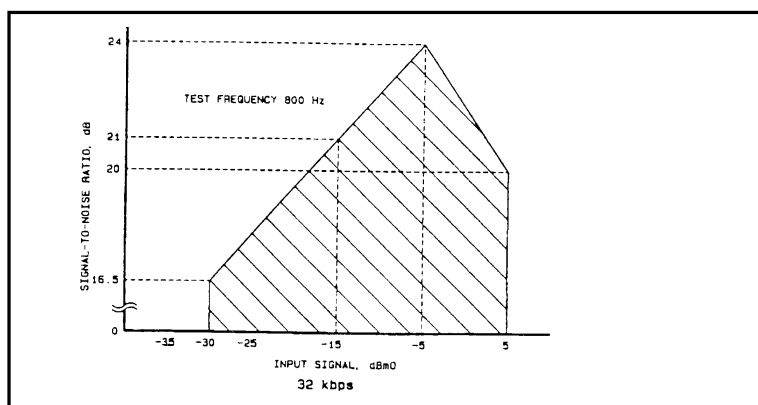

Figure F-6b. Signal to quantizing noise ratio vs input level for CVSD (32 kbps).

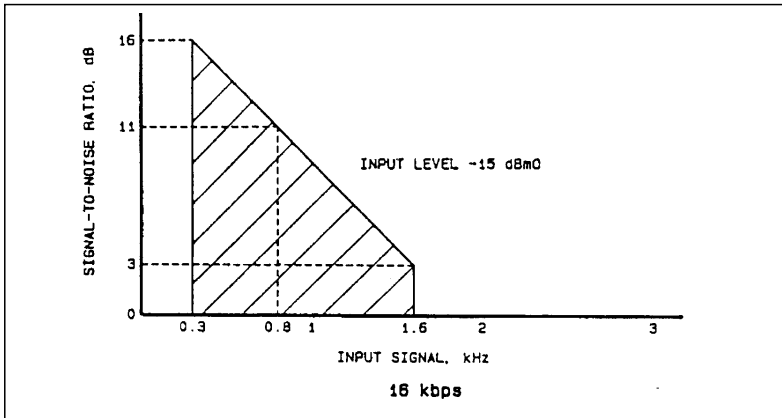

Figure F-7a. Signal to quantizing noise ratio versus frequency for CVSD (16 kbps).

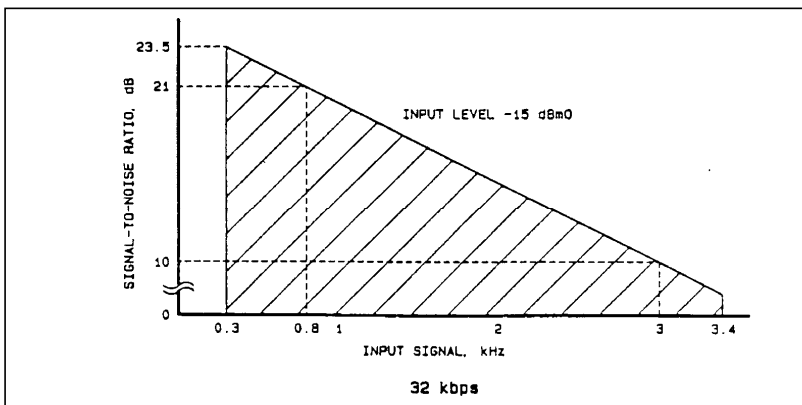

Figure F-7b. Signal to quantizing noise ratio versus frequency for CVSD (32 kbps).

## APPENDIX G

### ADARIO DATA BLOCK FIELD DEFINITIONS

#### 1.0 Data Block Format and Timing

The details of the ADARIO data block format are provided in Figure [G-1](#) and in the ADARIO data format field summary. As shown in Figure G-1, the eight session header words are the first eight words of the block. The channel packet for the highest priority (priority 1) channel is next, followed by the next lower priority channel packet (priority 2). Following the lowest priority channel, fill data consisting of all ones are inserted as required to complete the 2048-word data block.

Within the channel packet, the first five words are the channel header words including the partial word (PW). Following the channel header is the variable size channel data field. The channel data are organized in a last-in-first-out (LIFO) fashion. The first samples acquired in the block time interval appear in the last data word of the channel packet. The sample data are formatted into the 24-bit data word such that the first sample occupies the MSBs of the word. The next sample is formatted into the next available MSBs and so on until the word is full. As an example, data formatted into 8-bit samples is shown in Figure [G-2](#).

In cases where the 24-bit data word is not a multiple of the sample size, the sample boundaries do not align with the data words. In these cases, the samples at the word boundaries are divided into two words. The MSBs of the sample appear in LSBs of the first buffered word and the LSBs of the sample appear in the MSBs of the next buffered word. Since the channel data appears in a LIFO fashion in the ADARIO data block, the MSBs of the divided sample will occur in the data word following the word containing LSBs of the sample. Figure [G-3](#) depicts ADARIO timings.

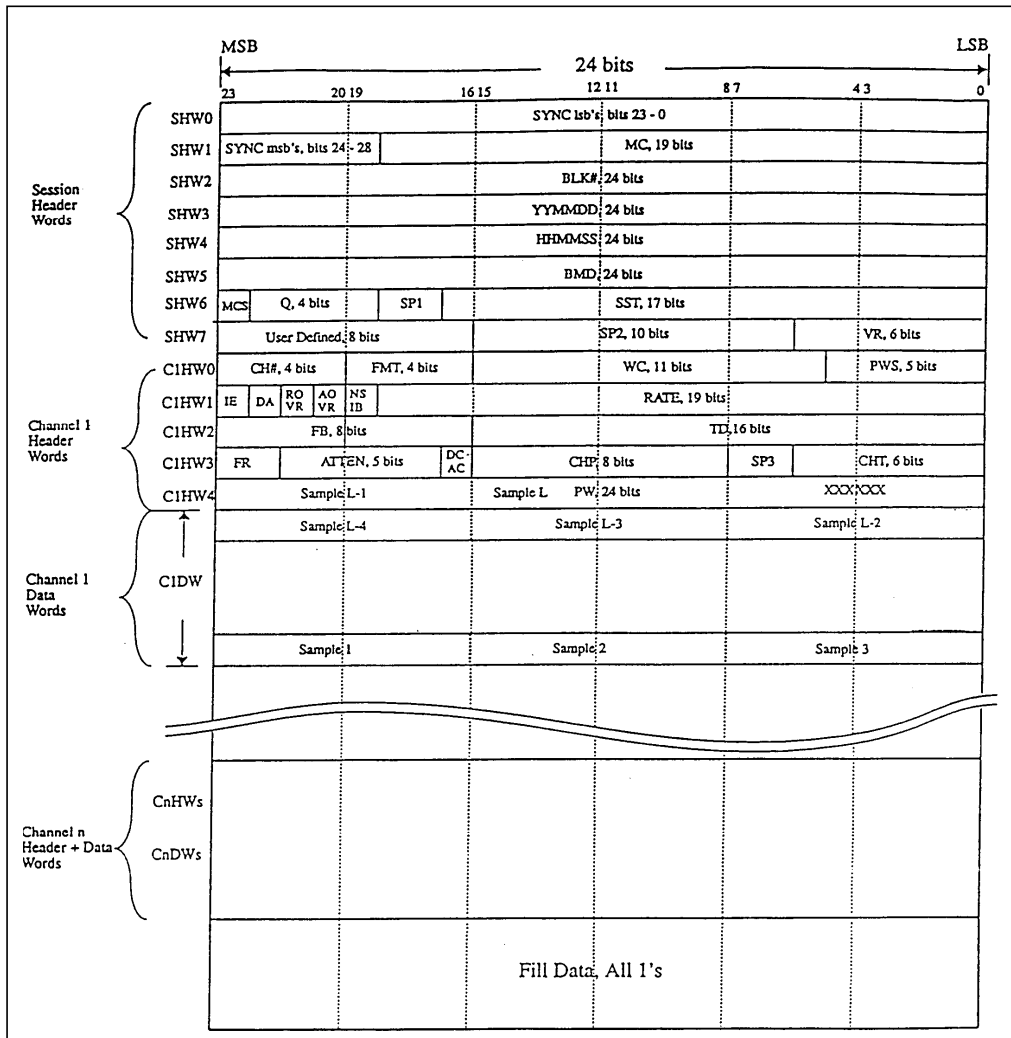

Figure G-1. ADARIO data format.

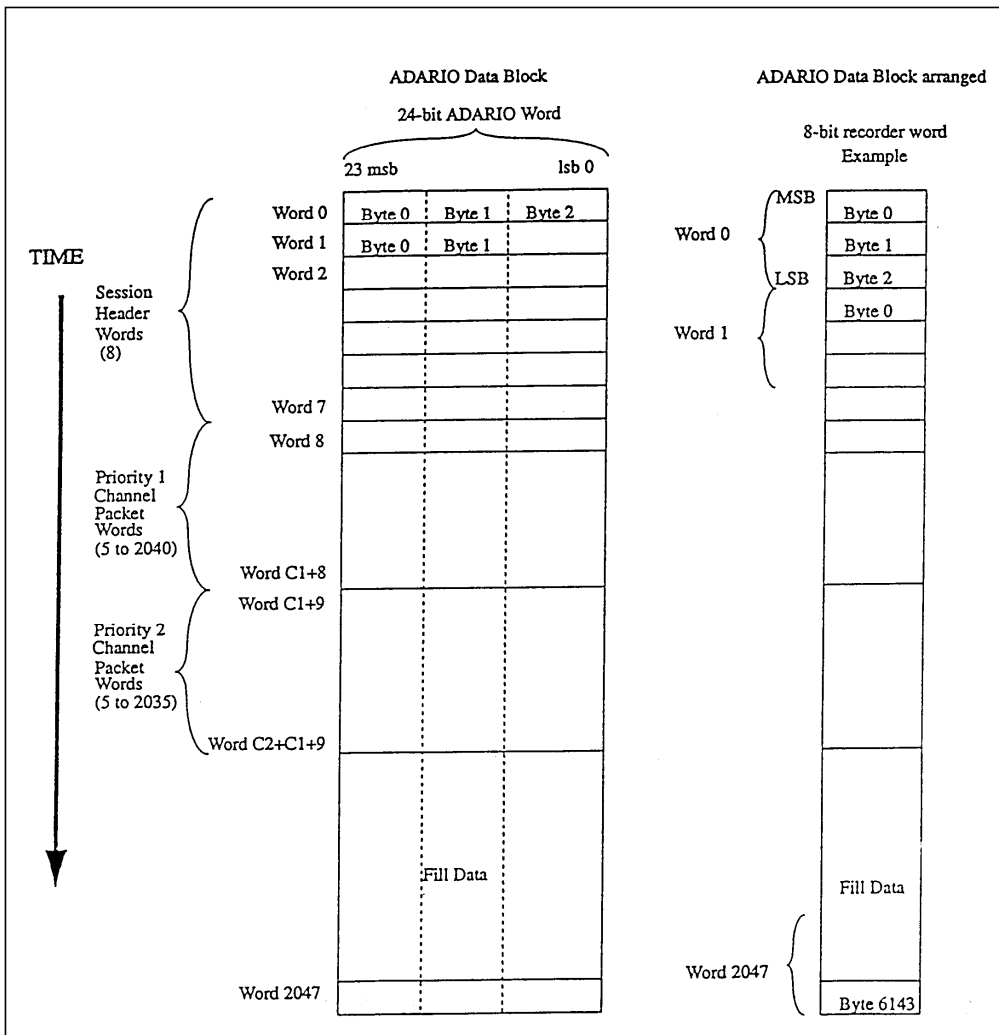

Figure G-2. ADARIO data blocks.

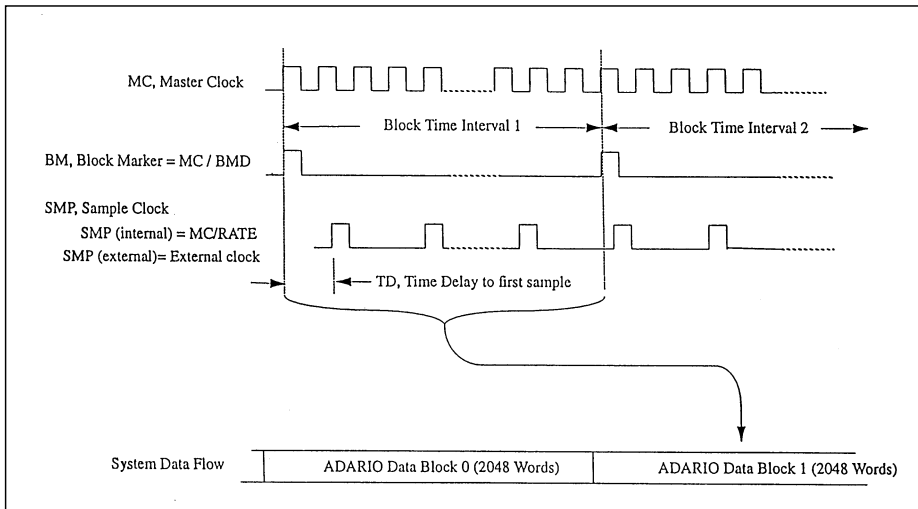

Figure G-3. ADARIO timing.

## 2.0 ADARIO Data Format Field Definitions Summary

### 2.1 Block Length - (2048 words, 24-bit words, fixed length)

### 2.2 Session Header - (8 words, fixed format)

SHW0 (bits 23 to 0)	SYNC Field, bits 0-23 of the 29-bit block sync. The LSBs of the block sync are 36E19C and are contained here.
SHW1 (bits 23 to 19)	SYNC Field, bits 24-28 of the 29-bit block sync. The MSBs of the block sync are 01001 and are contained here. The 29-bit block sync is fixed for all ADARIO configurations and chosen for minimal data cross correlation.
(bits 18 to 0)	MC, Master Clock, a 19-bit binary value in units of 250 Hz. MC is the clock frequency used to derive session and per channel parameters.
SHW2 (bits 23 to 0)	BLK#, ADARIO Data Block Number, a 24-bit binary value. BLK# is to zero at the start of each session and counts up consecutively. Rollover is allowed.

SHW3	(bits 23 to 0)	YYMMDD, Time Code Field, a BCD representation of the year (YY), month (MM), and day (DD). YYMMDD Time Code Field is updated during the record process once per second.
SHW4	(bits 23 to 0)	HHMMSS, Time Code Field, a BCD representation of the hour (HH), minute (MM), and second (SS). The HHMMSS Time Code Field is updated during the record process once per second.
SHW5	(bits 23 to 0)	BMD, Block Marker Divisor, a 24-bit binary value. BMD is established so that the block marker frequency, BM, may be derived from MC by $BM = MC/BMD$
SHW6	(bit 23)	MCS, Master Clock Source, a 1-bit flag. 1 = MC was generated internally. 0 = MC was provided from an external source.
	(bits 22 to 19)	Q, Number of active channels minus one, a 4-bit binary value. For example, 0 indicates that one channel is active.
	(bits 17 to 18)	SP1, Spare field 1, a 2-bit field. It is set to zero.
	(bits 16 to 0)	SST, Session Start Time, a 17-bit binary value in units of seconds. The integer number of seconds represents the session start time of day in seconds, where midnight starts with zero.
SHW7	(bits 23 to 16)	User Defined, an 8-bit field. May be input by the user at any time during a recording session. The interpretation of this bit field is left to the user.
	(bits 15 to 6)	SP2, Spare field 2, a 10-bit field. It is set to zero.
	(bits 5 to 0)	VR, Version number, a 6-bit binary value. Each update of the ADARIO format will be identified by a unique version number.

### 2.3 Channel 'n' Header

All channel headers contain five 24-bit ADARIO words with the following fixed format. The first logical channel, n=1, has the highest priority and its channel packet starts in the ninth word of the data block. Each active channel is represented by a channel packet that is present in the data block. The logical channel number, n, represents the relative priority of the channel and the order in which it appears in the data block.

CnHW0 (bits 23 to 20)	CH#, Physical Channel Number, a 4-bit binary value. 0 to 15 represents the physical location of the channel electronics in the ADARIO hardware. The user sees those locations labeled from 1 to 16.																
(bits 19 to 16)	FMT, Format code for the channel data word, a 4-bit binary value. The format code is used to define the size of the user data word by means of the following table: <table border="0" style="margin-left: 40px; margin-top: 10px;"> <tr> <td>15 = 24 bits</td> <td>7 = 8 bits</td> </tr> <tr> <td>14 = 22 bits</td> <td>6 = 7 bits</td> </tr> <tr> <td>13 = 20 bits</td> <td>5 = 6 bits</td> </tr> <tr> <td>12 = 18 bits</td> <td>4 = 5 bits</td> </tr> <tr> <td>11 = 16 bits</td> <td>3 = 4 bits</td> </tr> <tr> <td>10 = 14 bits</td> <td>2 = 3 bits</td> </tr> <tr> <td>9 = 12 bits</td> <td>1 = 2 bits</td> </tr> <tr> <td>8 = 10 bits</td> <td>0 = 1 bit</td> </tr> </table>	15 = 24 bits	7 = 8 bits	14 = 22 bits	6 = 7 bits	13 = 20 bits	5 = 6 bits	12 = 18 bits	4 = 5 bits	11 = 16 bits	3 = 4 bits	10 = 14 bits	2 = 3 bits	9 = 12 bits	1 = 2 bits	8 = 10 bits	0 = 1 bit
15 = 24 bits	7 = 8 bits																
14 = 22 bits	6 = 7 bits																
13 = 20 bits	5 = 6 bits																
12 = 18 bits	4 = 5 bits																
11 = 16 bits	3 = 4 bits																
10 = 14 bits	2 = 3 bits																
9 = 12 bits	1 = 2 bits																
8 = 10 bits	0 = 1 bit																
(bits 15 to 5)	WC, Word Count, an 11-bit binary value. WC is the number of full channel data words that should be in the nth channel packet. WC may range from 0 to 2040. A WC greater than the number of actual words in channel packet indicates a data rate overflow, which would occur when a low-priority channel is not provided sufficient space in the fixed length data block as a result of an uncontrolled data rate in a higher priority channel.																
(bits 4 to 0)	PWS, Partial Word Status, a 5-bit binary value. PWS is related to the number of samples in the partial word and may range from 0 to 23. PWS shall be computed as follows: <p style="margin-left: 40px;">If the number of full samples in the partial word equals zero, then PWS = 0.</p> <p style="margin-left: 40px;">If the number of full samples in the partial word does not equal zero, then PWS = Round Up [Unused bits In PW/Channel Sample Size].</p>																



CnHW1 (bit 23)	<p>IE, Channel Clock Source, a 1-bit flag.</p> <p>1 = The channel clock was generated internally.</p> <p>0 = The channel clock was provided from an external source.</p>
(bit 22)	<p>DA, Data type, a 1-bit flag.</p> <p>1 = The channel is operated as a digital channel.</p> <p>0 = The channel is operated as an analog channel.</p>
(bit 21)	<p>ROVR, Rate overrun in previous block, a 1-bit flag.</p> <p>1 = The nth channel packet in the previous data block experienced an overrun.</p> <p>0 = The nth channel packet in the previous data block did not experience an overrun.</p>
(bit 20)	<p>AOVR, Analog A/D Overrange in current block a 1-bit flag.</p> <p>1 = The nth channel in the current data block experienced an analog-to-digital conversion overrange condition.</p> <p>0 = The nth channel in the current data block did not experience an analog-to-digital conversion overrange condition.</p>
(bit 19)	<p>NSIB, No samples in current block, a 1-bit flag.</p> <p>1 = TRUE, there are no samples for the nth channel in the current block.</p> <p>0 = False, there are samples for the nth channel in the current block.</p>
(bits 18 to 0)	<p>RATE, Channel sample rate indicator, 19-bit binary value. The interpretation of the rate value depends on the condition of IE, the channel clock source flag.</p> <p>If IE = 1, then the value of rate is carried by the 16 LSBs of the rate field. Using rate, the frequency of the internal channel clock can be found by internal sample clock = (MC/RATE) - 1.</p> <p>If IE = 0, then rate is a 19-bit binary value in units of 250 Hz which equals the frequency of the external channel clock as provided by the user at the time of the setup.</p>



The definitions that are marked with an asterisk apply to analog channels and to particular hardware implementations of ADARIO. For the purposes of this standard, these fields are not used.

- \* CnWD2 (bits 23 to 16) FB, Filter Bandwidth, an 8-bit binary value. The formula for the bandwidth, BW, of the anti-aliasing filter used in an analog channel incorporates FB as  $BW = (FB/2) \cdot 10^{3+FR}$
- (bits 15 to 0) TD, Time Delay to first sample, a 16-bit binary value. TD is a measure of the time delay from the block marker, BM, to the first sample arriving at the nth channel during the current data block interval. TD is expressed as the number of master clock, MC, periods minus one.
- \* CnWD3 (bits 23 to 22) FR, Filter Range, a 2-bit binary value. The formula for the bandwidth, BW, of the anti-aliasing filter used in an analog channel incorporates FR as  $BW = (FB/2) \cdot 10^{3+FR}$
- (bits 21 to 17) ATTEN, Attenuation, a 5-bit binary value. ATTEN represents the setting of the input attenuator (or gain) on the nth channel at the time that the record was formed 0 = -15dB and 31 = +16dB with intermediate settings expressed in one dB steps.
- (bit 16) DCAC, Analog signal coupling, a 1-bit flag.  
1 = The channel is operated with dc coupling at the input.  
0 = The channel is operated with ac coupling at the input.
- (bits 15 to 8) CHP, Channel Parameter field, an 8-bit field. The interpretation of the CHP field depends upon the card type with which it is associated, as defined by the CHT field. Each card type established by the CHT field, as part of its definition, shall specify the form and interpretation of the CHP field. To date, four input card types have been established. The CHP fields are defined as follows:

(bits 15 to 8)	*	For CHT=0 remain undefined for the present analog single channel implementation except that the present hardware implementation expects an all zero field. Would be subject to future definition as long as all the zero fill is set aside.
(bits 15 to 8)	*	For CHT=1 remain unused for the present digital single channel implementations except that the present hardware implementation expects an all zero field. Would be subject to future definition as long as the all zero fill is set aside.
(bits 15 to 8)	*	For CHT=2 remain unused for the present dual-purpose channel implementations except that the present hardware implementation expects an all zero field. Would be subject to future definition as long as the all zero fill is set aside.
(bits 15 to 12)		For CHT=3 establish the number of subchannels that are multiplexed into the multichannel data carried by the nth channel.
(bits 11 to 8)		identify the subchannel number of the first sample contained in the nth channel packet of the data block.
(bits 7 to 6)		SP3, Spare field 3, a 2-bit field. It is set to zero.
(bits 5 to 0)		CHT, Channel Type, a 6-bit field. Defines the type of channel through which input data was acquired. Additional channel types to be defined by future users and developers.
	*	CHT=0 Single channel analog input
	*	CHT=1 Single channel digital input
	*	CHT=2 Single channel, dual-purpose, analog or digital input
	*	CHT=3 Multichannel analog input capable of multiplexing up to 16 analog inputs
	*	CHT=4 Single channel digital input, dual channel analog input (stereo) “L” channel on bits 15 to 8 of the sample word, “R” channel on bits 7 to 0 of the sample word
		CHT=5 Single channel, triple-purpose, analog, digital, submux, formatted input
CnWD4 (bits 23 to 0)		PW, Partial Word, A 24-bit field. PW contains the last samples of the data block. The most significant bits of

word contain the first sample, followed by the next sample in the next most significant bits. The number of samples in the PW is defined in the PWS field. The unused bits are not intentionally set and so contain random data.

Fill	(bits 23 to 0)	Fill, Fill Words consisting of all ones binary, used for fixed rate aggregate. Fill words may be omitted when variable rate aggregate can be accommodated resulting in variable length blocks of up to 2048, 24-bit words.
------	----------------	--

### 3.0 Submux Data Format Field Definitions

The details of the submux data format are shown in Figures [G-4a](#) and [b](#) and defined in the Submux Data Format Field Definitions Summary. Figure [G-5](#) shows a typical primary channel aggregate data content for fixed and variable rate channel. Submux data format is based on the sequential collection of the individual channel data blocks. Each channel data block is the sequential collection of presented input samples in a fixed period of time. This sequential collection results in a variable length, fixed rate, and channel data blocks. To accommodate fixed rate channels, fill is also defined. The aggregate data stream is composed of a block sync timing channel, followed by sequential channel data blocks, if enabled, followed by fill, if required, at fixed block rate.

The channel data blocks are the sequential collection of input samples bit packed into sequential 16-bit words over the block period of time. The data block is preceded by a three-word header that identifies the source (channel ID) of data, channel type of processing, packing format in the data block, bit count length of the valid data, and the time delay between the first sample and the block period. If data were internally sampled, the sample period is defined with the first sample being coincident with the start of block period. Channel type is used to define specific types of channels that provide timing, annotation, and synchronization functions that may be required by the specific primary channel or may be redundant and not required. Specific implementation of the required channels may provide only the required channels with specific implementation constraints that limit the aggregate rate or the range of any specific field.

The submux format is based on a 16-MHz clock defining all timing. The derived clock is the 16-MHz clock divided in binary steps as defined by  $2^{\text{BRC}}$  that defines all timing and internal sampling. Block period is 20 160 derived clock periods which limits the submux aggregate to 256 Mbps, limits the maximum block rate to 793.65 blocks per second, and in conjunction with a 16-bit bit count field, limits the subchannel maximum data rate to 52 Mbps.

#### 4.0 SubMux Data Format Field Definitions Summary

- 4.1 Frame length. Variable or fixed with fill. Minimum is 3-word block sync plus one channel block, maximum is 20 160x16-bit words.
- 4.2 Block length: Variable from 3x16-bit words to 4099x16-bit words per channel data block. Specified by CHT>0 and integer of (Bit\_Count+15/16). May be limited by implementation.
- 4.3 Block sync: Defined by Channel ID = 31, 3-word block, 2-word sync. Defines a period of 20 160 derived clocks.
- 4.4 General form: All Channel data blocks contain this information in the 3-word header.

HW1 (bits 15 to 11) CHN ID, Channel ID number, from 0 to 30 binary number represents normal channel of any type. CHN ID = 31 reserved for Block Sync.

(bits 10 to 8) CHT, Channel Type, from 0 to 7 defines type of processing performed on the data and the format of header word fields.

CHT = 0	Timing channel, block sync or time tag, 3-word only
CHT = 1	Annotation text or block count, variable length
CHT = 2	Digital serial external or internal clock, variable
CHT = 3	Digital parallel external clock, variable
CHT = 4	Analog wide band, variable
CHT = 5	Analog stereo, variable
CHT = 6	TBD (to be defined by future implementation)
CHT = 7	TBD

Variable length: General form with variable data block length

HW1 (bits 15 to 11) CHN ID, Channel ID number, from 0 to 30 binary number represents normal channel of any type.

(bits 10 to 8) CHT, Channel Type, from 1 to 7 defines type of processing performed on the data and the format of header word fields.

(bits 7 to 4) FMT, Format, defines the number of bits minus one in each sample. Data block sample size (bits) = (FMT+1). Range 0 to 15, binary format.

(bits 3 to 0) ST1 to ST4, status bits, define dynamic conditions within this block period such as over range.

HW2(bits 15 to 0) Bit\_Count defines the number of valid data bits in the data block starting with the most significant bit of the first data word DW1. Variable word length of the data block is the Integer of  $\{(Bit\_Count + 15)/16\}$ . Range 0 to 65 535, binary format.

HW3(bit 15) I/E, Internal/External clock

(bits 15 to 0) Depends on CHT field, defines block count, time delay, or sample period.

4.5 Block Sync: Defines the start of channel data blocks and start of block period that lasts for 20 160 derived clocks.

HW1 (bits 15 to 0) SYNC 1 = F8C7 hex, defines the first sync word.

HW2 (bits 15 to 0) SYNC 2 = BF1E hex, defines the second sync word.

HW3 (bits 15 to 13) BRC, Block Rate Clock, defines the binary divisor for the 16 MHz system clock.  $Derived\ CLK = 16\ MHz / 2^{BRC}\ MHz$ . Block rate =  $Derived\ CLK / 20\ 160\ Hz$ . Period =  $1 / Derived\ CLK$ .

(bit 12) FILL, indicates if the primary channel requires fill for constant rate.

(bits 11 to 4) TBD

(bit 3) AOE, Aggregate Overrun Error if set indicates that the aggregate of the enabled channels exceeds the submux aggregate (data truncated to 20 160 words between sync).

(bit 2) PCRE, Primary Channel Rate Error if set indicates that primary channel is unable to maintain the aggregate rate of the submux. Excess blocks are truncated.

(bits 1 to 0) ST3, ST4, Status reserved.

4.6 Time Tag: Defines the time tag channel for time stamping the frame.

HW1 (bits 15 to 11) CHN ID, Channel ID number, from 0 to 30 binary number represents normal channel.

(bits 10 to 8) CHT = 0, Channel Type = 0, Time Tag IRIG Time code processing and 3-word format.

HW	(bits 7 to 0)	DAYS, Most significant 8 bits of Time Code Days field. BCD format.
	(bits 15 to 14)	DAYS, Least significant 2 bits of Time Code Days field. BCD format.
	(bits 13 to 8)	HOURS, Time Code Hours 6 bit field. BCD format.
HW	(bits 7 to 0)	MINUTES, Time Code Minutes 7 bit field. BCD format.
	(bits 15 to 8)	SECONDS, Time Code Seconds 7 bit field. BCD format.
	(bits 7 to 0)	FRACTIONAL SECONDS, Time Code Fractional Seconds 8 bit field. BCD format.

4.7 Annotation Text: Defines block count and annotation text that pertains to the subchannels at this time.

HW1	(bits 15 to 11)	CHN ID, Channel ID number, from 0 to 30 binary number represents normal channel.
	(bits 10 to 8)	CHT = 1, Channel Type = 1, Block Count and Annotation Text if any.
	(bits 7 to 4)	FMT = 7, Format = 7, defines 8 bit ASCII character in text.
	(bit 3 )	NC, No Characters (Bit_Count = 0) Block count only.
	(bits 2 to 0)	OVR, PE, OE, Overrun Parity and async framing error.
HW	(bits 15 to 0)	Bit_Count defines the number of valid data bits in the data block starting with the MSB of the first data word DW1. Variable word length of the data block is the Integer of $\{(Bit\_Count + 15)/16\}$ . Range 0 to 65 535, binary format.
HW	(bits 15 to 0)	Block_Count sequential block numbering with rollover at maximum. Range 0 to 65 535, binary format.
DW1	(bits 15 to 8)	1st CHARACTER, first text character.
DW	(bits 8 or 0)	Last CHARACTER, LSB is defined by the Bit Count.

4.8 Digital Serial External CLK: Defines digital serial data such as PCM externally clocked.

HW1	(bits 15 to 11)	CHN ID, Channel ID number, from 0 to 30 binary number represents normal channel.
-----	-----------------	--

	(bits 10 to 8)	CHT = 2, Channel Type = 2, digital serial or data and clock over sampled data.
	(bits 7 to 4)	FMT = 0 Format = 0, defines 1-bit data samples.
	(bit 3 )	NSIB, No Samples In Block (Bit_Count=0) header only.
	(bit 2 )	OVR, Overrun indicates that input is clocking at faster than specified rate. Data is truncated at specified bit rate (Bit Count per Block).
HW	(bits 15 to 0)	Bit_Count, defines the number of valid data bits in the data block starting with the most significant bit of the first data word DW1. Variable word length of the data block is the Integer of $\{(Bit\_Count + 15)/16\}$ . Range 0 to 65 535, binary format. Limited by set maximum rate.
HW	(bit 15 )	I/E = 0, Internal / External clock flag indicates that external clocking was used with relative phasing to block as specified in next field.
	(bits 14 to 0)	Time Delay provides the measure of time between start of block period and the first external clock in derived clock periods. Range 0 to 20 160, binary format.
DW1	(bit 15)	DS <sub>1</sub> , first data sample at the first clock time in the block.
Dw <sub>n</sub>	(bit L)	DS <sub>L</sub> , last data sample in this block period.

4.9 Digital Serial Internal CLK: Defines digital serial data low rate (> 2 samples per block period) internally oversampled.

HW1	(bits 15 to 11)	CHN ID, Channel ID number, from 0 to 30 binary number represents normal channel.
	(bits 10 to 8)	CHT = 2, Channel Type = 2, Digital serial or data and clock over sampled data.
	(bits 7 to 4)	FMT = 0 Format = 0, defines 1-bits data samples.
	(bits 3 to 0)	0, reserved.
HW2	(bits 15 to 0)	Bit_Count defines the number of valid data bits in the data block starting with the most significant bit of the first data word DW1. Variable word length of the data block is the Integer of $\{(Bit\_Count + 15)/16\}$ . Range 0 to 65 535, binary format. Limited by set maximum rate.



HW3	(bit 15)	I/E = 1, Internal Sampling flag indicates that internal sampling was used as specified in next field.
	(bits 14 to 9)	TBD
	(bits 8 to 0)	SAMPLE PERIOD, defines the period of the over-sampling clock that samples data and clock, in derived clock periods. Range 0 to 4 mega samples per second, binary format.
DW1	(bit 15)	DS <sub>1</sub> , first data sample at block time.
	(bit 7)	CS <sub>1</sub> , first clock sample at block time.
DWn	(bit 8)	DS <sub>L</sub> , last data sample in this block period.
	(bit 0)	CS <sub>L</sub> , last clock sample in this block period.

4.10 Digital Parallel External CLK: Defines digital data including serial externally clocked.

HW1	(bits 15 to 11)	CHN ID, Channel ID number, from 0 to 30 binary number represents normal channel.
	(bits 10 to 8)	CHT = 3, Channel Type = 3, Digital parallel or serial data.
	(bits 7 to 4)	FMT, Format, defines the number of bits minus one in each sample. Data block sample size (bits) = (FMT+1). Range 0 to 15, binary format.
	(bit 3)	NSIB, No Samples In Block (Bit_Count = 0) Header only.
	(bit 2)	OVR, Overrun indicates that input is clocking at faster than specified rate. Data is truncated at specified bit rate (Bit Count per Block).
HW2	(bits 15 to 0)	Bit_Count defines the number of valid data bits in the data block starting with the most significant bit of the first data word DW1. Variable word length of the data block is the Integer of ((Bit_Count + 15)/16). Range 0 to 65 535, binary format. Limited by set maximum rate.
HW3	(bit 15)	I/E = 0, Internal / External clock flag indicates that external clocking was used with relative phasing to block as specified in next field.

(bits 14 to 0) Time delay provides the measure of time between start of block period and the first external clock in derived clock periods. Range 0 to 20 160, binary format.

DW<sub>1</sub> (bit 15) DS<sub>1</sub>, MSB of the first data sample at the first clock time in the block.

DW<sub>n</sub> (bit L) DS<sub>L</sub>, LSB of the last data sample in this block period.

4.11 Analog Wide Band: Defines analog wide band data using a sampling A/D and internal block synchronous clock.

HW1 (bits 15 to 11) CHN ID, Channel ID number, from 0 to 30 binary number represents normal channel.

(bits 10 to 8) CHT = 4, Channel Type = 4, analog wide band sampled data.

(bits 7 to 4) FMT, Format, defines the number of bits minus one in each sample. Data block Sample Size (bits) = (FMT+1). Range 0 to 15, binary format. Limited by the A/D resolution.

(bit 3) AOR, Analog over range (A/D 4-msb = F).

(bits 2 to 0) ST2 to ST4, reserved status

HW2 (bits 15 to 0) Bit\_Count defines the number of valid data bits in the data block starting with the MSB of the first data word DW1. Variable word length of the data block is the Integer of ((Bit\_Count + 15)/16). Range 0 to 65 535, binary format. Limited by set maximum rate.

HW3 (bit 15) I/E = 1, Internal Sampling flag indicates that internal sampling was used as specified in next field.

(bits 14 to 12) TBD

(bits 11 to 0) Sample Period defines the period of the over-sampling clock that samples data and clock, in derived clock periods. Range 0 to 4m samples per second, binary format.

DW<sub>1</sub> (bit 15) DS<sub>1</sub>, MSB of the first data sample at the first clock time in the block.

DW<sub>n</sub> (bit L) DS<sub>L</sub>, LSB of the last data sample in this block period.

4.12 Analog Stereo "L" & "R": Defines analog stereo data using a sigma-delta A/D and internal block synchronous clock with tracking Finite Impulse Response (FIR) filter.

HW1	(bits 15 to 11)	CHN ID, Channel ID number, from 0 to 30 binary number represents normal channel.
	(bits 10 to 8)	CHT = 5, Channel Type = 5, Analog stereo voice band data.
	(bits 7 to 4)	FMT, Format defines the number of bits minus one in each sample. Data block sample size (bits) = (FMT+1). Range 0 to 15, binary format. Limited by the A/D resolution.
	(bit 3)	LAOR, left subchannel over range.
	(bit 2)	RAOR, right subchannel over range.
	(bits 1 to 0)	ST2 to ST4, reserved status.
HW2	(bits 15 to 0)	Bit_Count defines the number of valid data bits in the data block starting with the MSB of the first data word DW1. Variable word length of the data block is the Integer of $\{(Bit\_Count + 15)/16\}$ . Range 0 to 65 535, binary format. Limited by set maximum rate.
HW3	(bit 15)	I/E = 1, Internal Sampling flag indicates that internal sampling was used as specified in next field.
	(bit 14)	ENL, Enable Left subchannel.
	(bit 13)	ENR, Enable Right subchannel.
	(bit 12)	TBD
	(bits 11 to 0)	Sample period defines the period of the over-sampling clock that samples data and clock, in derived clock periods. Range 3.76 to 40K samples per second, binary format.
DW1	(bit 15)	DS <sub>1</sub> , MSB of the first data sample left subchannel if enabled.
	(bit 15- (FMT-1)	DS <sub>1</sub> , MSB of the first data sample right subchannel if enabled, else second sample.
DWn	(bit L)	DS <sub>L</sub> , LSB of the last data sample in this block period.
4.13	<u>Fill</u> :	Defines fill word that can be inserted at the end of all channel data blocks if required by the constant rate primary channel.
Fwx	(bits 15 to 0)	FILL, defined as FFFF hex word.

		16 BITS																		
		15	14	13	12	11	10	9	8	7	6	5	4	3	2	1	0			
General Form	HW1	CHN ID				CHT				FMT				ST1	ST2	ST3	ST4			
	HW2																			
	HW3	I/E	TIME DELAY or SAMPLE PERIOD																	
Frame Sync	HW1	CHN ID = 1F				CHT = 0				SYNC 1 = F8C7 hex (full word)										
	HW2	SYNC 2 = BF1E hex																		
	HW3	BRC		FILL											AOE	PCR	ST3	ST4		
Time Tag	HW1	CHN ID = 0 to 30				CHT = 0				MSB	DAYS (BCD)									
	HW2	DAYS lsb	HOURS (BCD)				lsb	MINUTES (BCD)				lsb								
	HW3	SECONDS (BCD)				lsb	FRACTIONAL SECONDS				lsb									
Annotation Text	HW1	CHN ID = 0 to 30				CHT = 1				FMT = 7				NC	OVR	PE	OE			
	HW2	BIT_COUNT																		
	HW3	BLOCK COUNT																		
	DW1	msb	1 <sup>ST</sup> CHARACTER				lsb	msb	2 <sup>ND</sup> CHARACTER				lsb							
	:																			
	DWn	msb	Last CHARACTER				lsb	UNDEFINED if not last												
Digital Srl. Ext. CLK	HW1	CHN ID = 0 to 30				CHT = 2				FMT = 0				NSIB	OVR	ST3	ST4			
	HW2	BIT_COUNT = L																		
	HW3	I/E=0	TIME DELAY																	
	DW1	DS <sub>1</sub>	DS <sub>2</sub>	DS <sub>3</sub>	DS <sub>4</sub>	DS <sub>5</sub>	DS <sub>6</sub>	DS <sub>7</sub>	DS <sub>8</sub>	DS <sub>9</sub>	DS <sub>1</sub>	DS <sub>1</sub>	DS <sub>1</sub>	DS <sub>1</sub>	DS <sub>1</sub>	DS <sub>1</sub>	DS <sub>1</sub>			
	:																			
	DWn							DS <sub>L-1</sub>	DS <sub>L</sub>	UNDEFINED if not last										

Figure G-4a. Submux data format.

		15	14	13	12	11	10	9	8	7	6	5	4	3	2	1	0
Digital Serial Int. CLK	HW1	CHN ID = 0 to 30					CHT = 2			FMT = 0				0	0	ST3	ST4
	HW2	BIT_COUNT = L															
	HW3	I/E=1	SAMPLE PERIOD														
	DW1	DS <sub>1</sub>	DS <sub>2</sub>	DS <sub>3</sub>	DS <sub>4</sub>	DS <sub>5</sub>	DS <sub>6</sub>	DS <sub>7</sub>	DS <sub>8</sub>	CS <sub>1</sub>	CS <sub>2</sub>	CS <sub>3</sub>	CS <sub>4</sub>	CS <sub>5</sub>	CS <sub>6</sub>	CS <sub>7</sub>	CS <sub>8</sub>
	DWn	DS <sub>L-7</sub>	DS <sub>L-6</sub>	DS <sub>L-5</sub>	DS <sub>L-4</sub>	DS <sub>L-3</sub>	DS <sub>L-2</sub>	DS <sub>L-1</sub>	DS <sub>L</sub>	CS <sub>L-7</sub>	CS <sub>L-6</sub>	CS <sub>L-5</sub>	CS <sub>L-4</sub>	CS <sub>L-3</sub>	CS <sub>L-2</sub>	CS <sub>L-1</sub>	CS <sub>L</sub>
Digital Parallel Ext. CLK	HW1	CHN ID = 0 to 30					CHT = 3			FMT=0 to 15 (shown =6)				NSIB	OVR	ST3	ST4
	HW2	BIT_COUNT = L															
	HW3	I/E=0	TIME DELAY														
	DW1	MSB	1 <sup>ST</sup> SAMPLE					MSB	2 <sup>ND</sup> SAMPLE					3 <sup>RD</sup> SAMPLE			
	DWn		MSB Last SAMPLE					LSB=bit L			UNDEFINED if not last						
Analog Wide Band	HW1	CHN ID = 0 to 30					CHT = 4			FMT=0 to 15 (shown =7)				AOR	ST2	ST3	ST
	HW2	BIT_COUNT = L															
	HW3	I/E=1	SAMPLE PERIOD														
	DW1	MSB	1 <sup>ST</sup> SAMPLE					MSB	2 <sup>ND</sup> SAMPLE								
	DWn	MSB	Last SAMPLE					LSB=bit L			UNDEFINED if not last						
Analog Stereo "L" & "R"	HW1	CHN ID = 0 to 30					CHT = 5			FMT=0 to 15 (shown =7)				LAOR	RAOR	ST3	ST4
	HW2	BIT_COUNT = L															
	HW3	I/E=1	ENL	ENR	SAMPLE PERIOD												
	DW1	MSB	1 <sup>ST</sup> SAMPLE "L"					MSB	1 <sup>ST</sup> SAMPLE "R"								
	DWn	MSB	Last SAMPLE					UNDEFINED if not last									
Fill	FW	Fill Word = FFFF hex															

Figure G-4b. Submux data format.

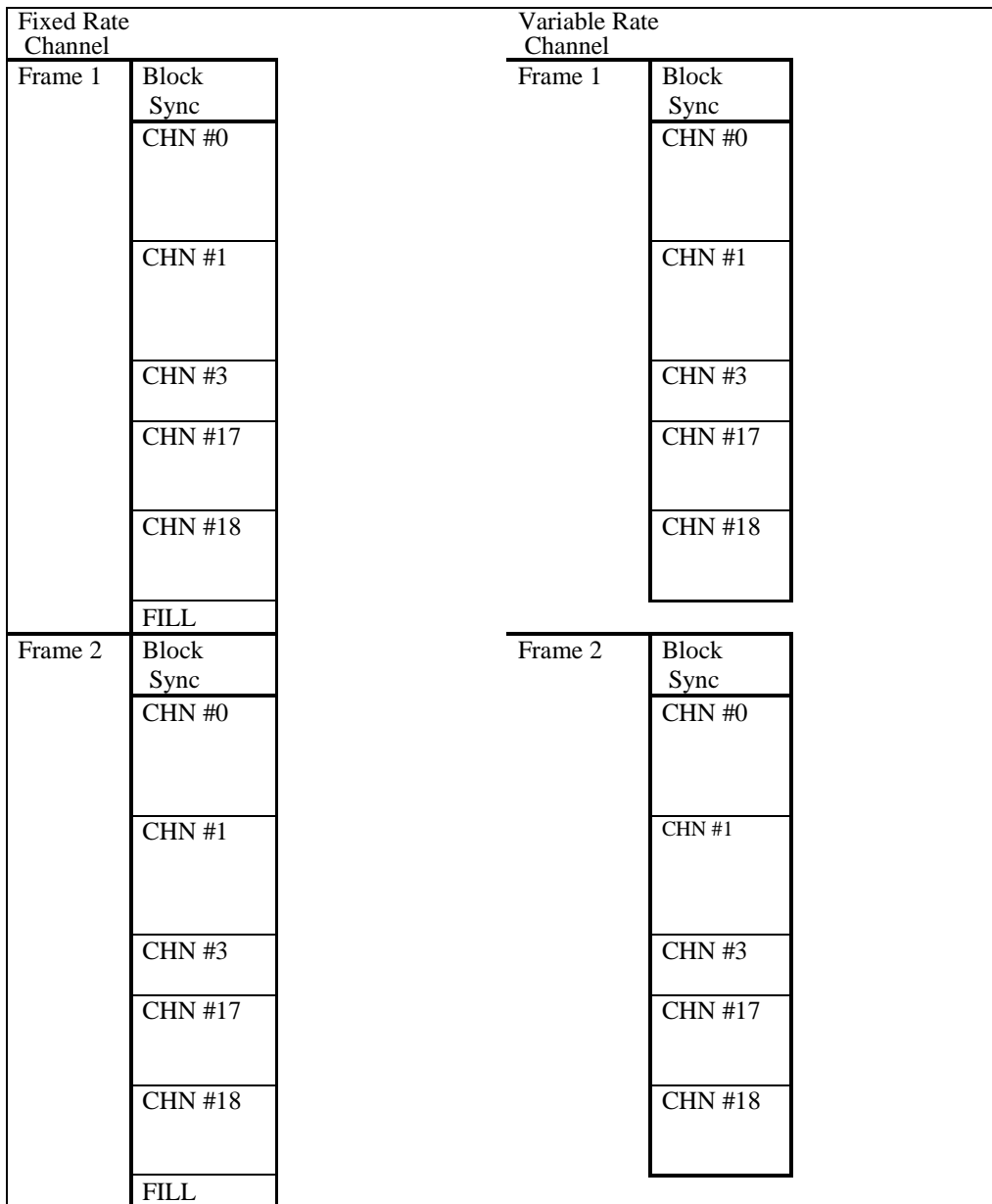

Figure G-5. Submux aggregate format.

## APPENDIX H

### APPLICATION OF THE TELEMETRY ATTRIBUTES TRANSFER STANDARD

#### 1.0 Elements of the Telemetry Attributes Transfer Process

Interchange of telemetry attributes occurs between vehicle instrumentation organizations (the source) and the telemetry ground stations (the destination). Interchange may also take place between ranges. The following are typical elements of this process:

- data entry system
- source data base
- export program
- interchange medium [this standard]
- import program
- destination data base
- telemetry setup system
- telemetry processing equipment.

These elements are depicted in Figure [H-1](#) and are defined as follows:

1.1 The data entry system is the source organization's human interface where telemetry attributes are entered into a computer-based system. (Not affected by this standard.)

1.2 The source database is where telemetry attributes are maintained in a form appropriate to the local organization's needs. (Not affected by this standard.)

1.3 The export program converts the telemetry attributes from the source database format to the format defined by this standard and stores them on the interchange medium.

1.4 The interchange medium contains the telemetry attributes being transferred from the source organization to the destination organization. Format and contents are defined by this standard.

1.5 The import program reads the standardized interchange medium and converts the attributes to the destination data base format in accordance with local needs, system characteristics, and limitations.

1.6 The destination data base is where telemetry attributes are maintained in a form suitable to the local ground station's needs. (Not affected by this standard.)

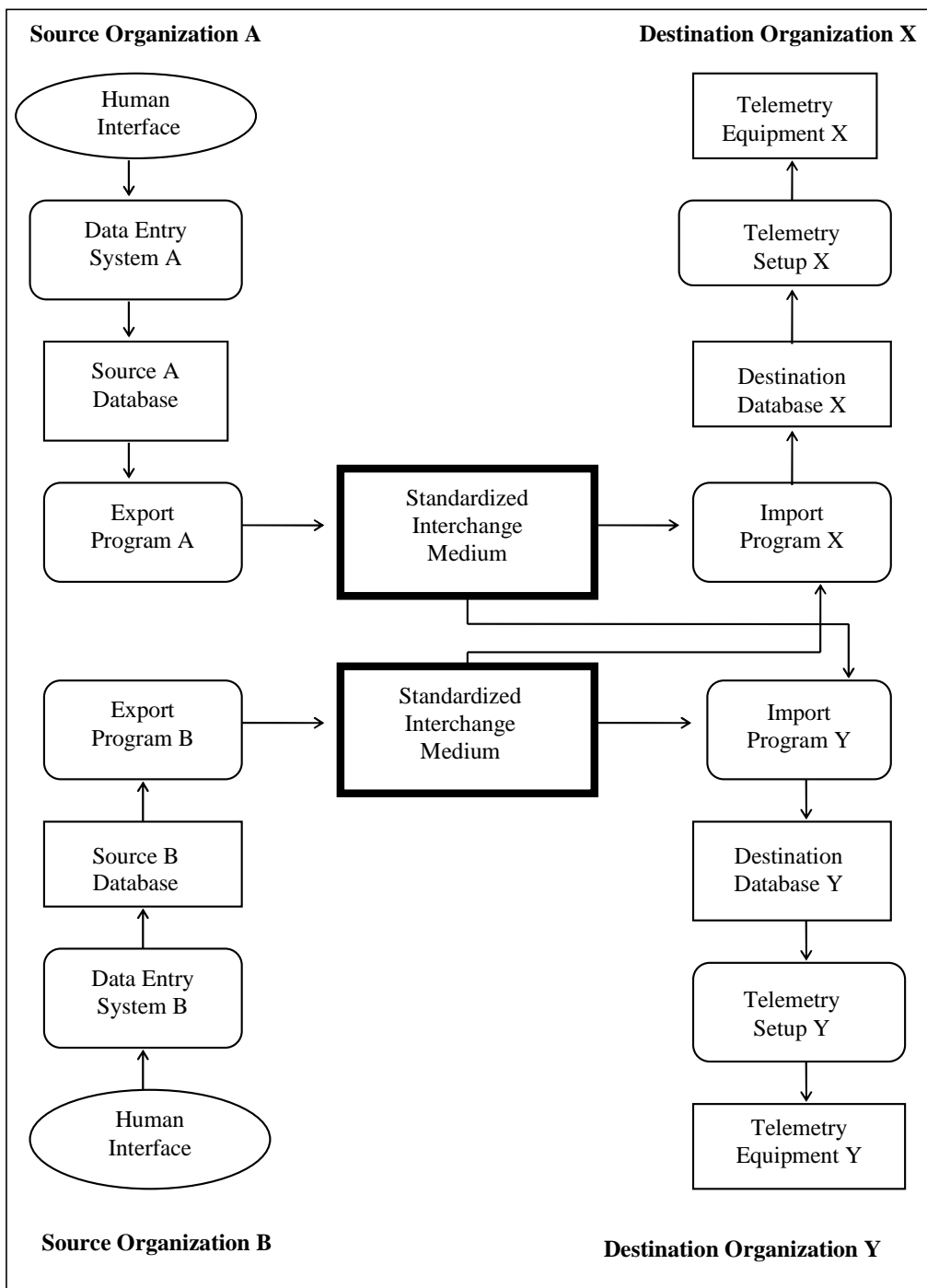

Figure H-1. Typical elements of the telemetry attributes transfer process.



7. The telemetry setup system accesses the destination database to load the telemetry processing equipment. (Not affected by this standard.)

8. The telemetry processing equipment is where the attributes will ultimately be used to properly handle the data being transmitted. (Not affected by this standard.)

The interchange medium is intended as a standard means of information exchange. The source and destination organizations are not constrained by this standard as to how the attributes are stored, viewed, used, or maintained.

To use the attribute transfer standard, import and export software must be developed. Once in place, these programs should eliminate the need for test item or project-specific software at either the supplying (source) organizations or the processing (destination) organizations.

This page intentionally left blank.

## APPENDIX I

### TELEMETRY ATTRIBUTES TRANSFER STANDARD COVER SHEET

#### 1.0 Cover Sheet

Each attribute transfer file (disk or tape) should be accompanied by a cover sheet describing the originating agency's computer system used to construct the attribute file. The recommended format for this cover sheet is given here.

<b>Telemetry Attributes Transfer Standard</b>	
Date:	MM\DD\YY
From:	Name
	Address
	Telephone
To:	Name
	Address
	Telephone
Originating computer system:	
Computer make and model:	
Medium characteristics:	
Description:	
Comments:	

Figure I-1. Sample cover sheet for attribute transfer files.

This page intentionally left blank.

## APPENDIX J

### TELEMETRY ATTRIBUTES TRANSFER STANDARD FORMAT EXAMPLE

The following example is for illustrative purposes and is by no means a complete attributes file; it is representative of the types of information likely to be transferred. Many attributes are purposely omitted to simplify the example. In some of the groups, only those entries necessary to link to other groups are provided. Attributes, which link the various groups together, are indicated in **boldface**.

Selected attributes are described in text form as an aid to following the example. *All text, which describes the example, is printed in italics.* All text, which is part of the example file, is printed in plain text.

The example file being transferred consists of the attributes of a single RF data source and an analog tape containing two data sources. The RF data source is a PCM signal, which contains an embedded asynchronous wave train. The two recorded data sources are PCM signals: one is an aircraft telemetry stream, and the other is a radar data telemetry stream. Figure [J-1](#) shows the example file in terms of the attribute groups and their interrelationships. Refer to the attribute tables while reviewing the example.

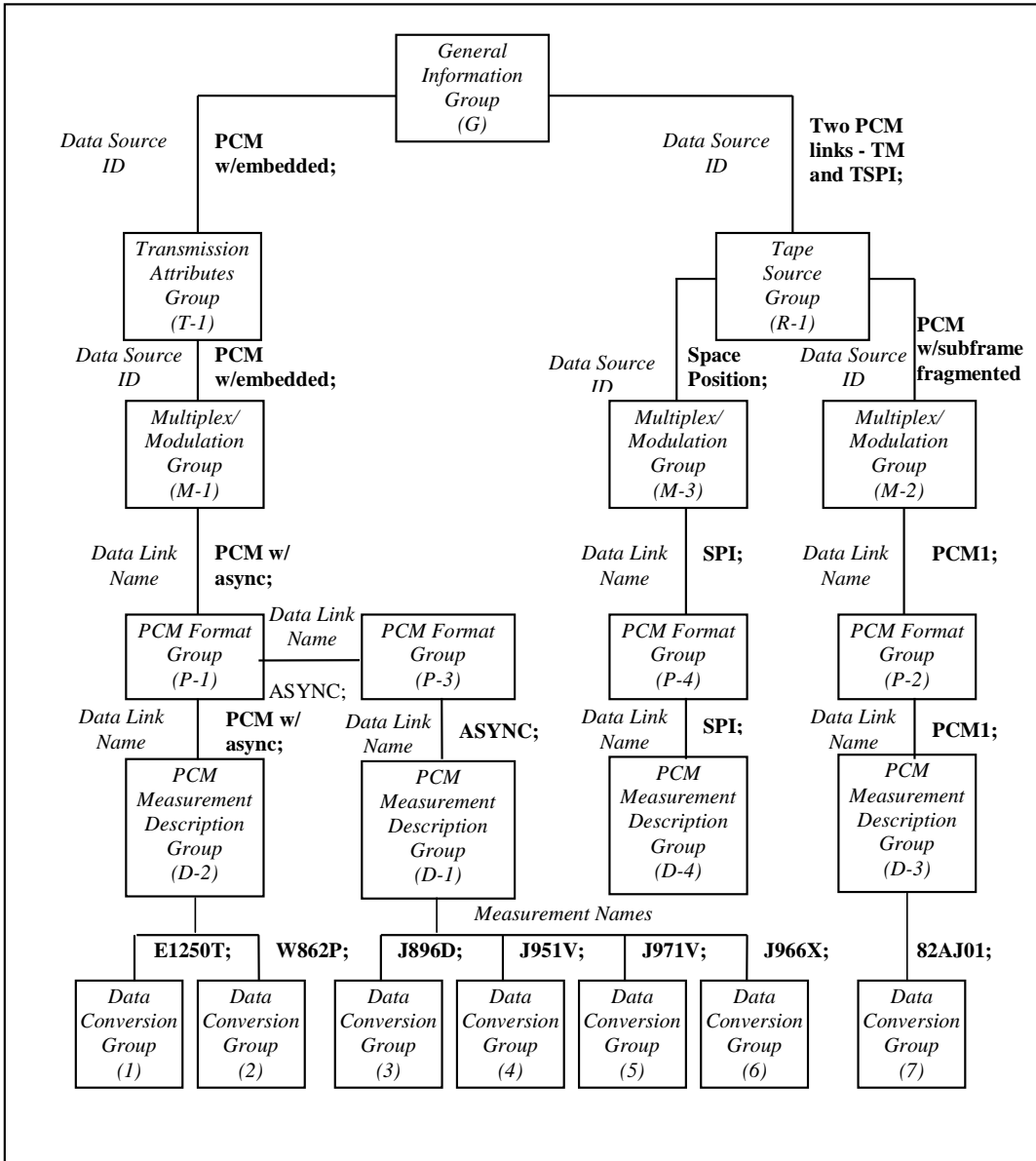

Figure J-1. Group linkages.

General Information Group (G)

*Program name, test name, origination date, revision number: 0,  
test number: 13.*

G\PN: TMATS example; G\TA: Wright Flyer; G\OD: 07-12-41; G\RN:0; G\TN:13; G\POC1-1:  
Wilbur; G\POC2-1: Bikes,LTD; G\POC3-1: Dayton;  
G\POC4-1: 555-1212;

*Live data source.*

**G\DSI-1:PCM w/embedded; G\DST-1:RF;**

*Tape source.*

**G\DSI-2:Two PCM links - TM & TSPI; G\DST-2:TAP;**  
G\COM: I hope this flies.; G\POC1-2: Orville;  
G\POC2-2:Bikes,LTD; G\POC3-2: Dayton; G\POC4-2: 555-1212;

Transmission Attributes Group (T-1)

*Frequency: 1489.5, RF bandwidth: 100, data bandwidth: 100;  
not encrypted, modulation type: FM, total carrier modulation: 500,  
no subcarriers, transmit polarization: linear.*

**T-1\ID:PCM w/embedded; T-1\RF1:1489.5; T-1\RF2:100; T-1\RF3:100;**  
T-1\RF4:FM; T-1\RF5:500; T-1\SCO\N:NO; T-1\AN2:LIN; T-1\AP\POC1:  
Pat Tern; T-1\AP\POC2:Transmissions,Inc.;  
T-1\AP\POC3:Amityville,NY; T-1\AP\POC4:800-555-1212;

Tape Source Attributes Group (R-1)

**R-1\ID:Two PCM links - TM & TSPI;**  
R-1\R1:Reel #1; R-1\TC1:ANAL; R-1\TC2:ACME; R-1\TC3:795;

*Tape width: 1 inch, reel diameter: 14 inches, 14 tracks,  
record speed: 7.5 inches/second.*

R-1\TC4:1.0; R-1\TC5:14.0; R-1\N:14; R-1\TC6:7.5;

*Rewound: Yes, manufacturer: ZZ; model: 13, original: yes.*

R-1\TC8:Y; R-1\RI1:ZZ; R-1\RI2:13; R-1\RI3:Y;  
R-1\RI4:07-12-91-07-55-59; R-1\POC1:Mr. Reel; R-1\POC2:Tape Creations; R-1\POC3:Anywhere,Ttown; R-1\POC4:555-1212;

*Track Number 2 contains aircraft telemetry PCM (w/subframe fragmented)*

R-1\TK1-1:2; R-1\TK2-1:FM/FM;  
**R-1\DSI-1:PCM w/subframe fragmented; R-1\TK3-1:FWD;**

*Track Number 4 contains Space Position Information via PCM link*

R-1\TK1-2:4; **R-1\DSI-2:Space Position Information;**

Multiplex/Modulation Groups (M-1, M-2, M-3)

*Baseband type: PCM, modulation sense: POS, baseband data: PCM,  
low pass filter type: constant amplitude*

**M-1\ID:PCM w/embedded; M-1\BB1:PCM; M-1\BB2:POS; M-1\BSG1:PCM;  
M-1\BSF2:CA;  
M-1\BB\DLN:PCM w/async;**

**M-2\ID:PCM w/subframe fragmented; M-2\BB\DLN:PCM1;**

**M-3\ID:Space Position; M-3\BB\DLN:SPI;**

---

PCM Format Attributes Groups (P)

*P-1 is a live PCM signal and contains the asynchronous wave train (see Figure J-2).*

*P-2 is a recorded signal (see Figure J-3).*

*P-3 is the asynchronous wave train (see Figure J-4).*

*P-4 is a recorded signal.*



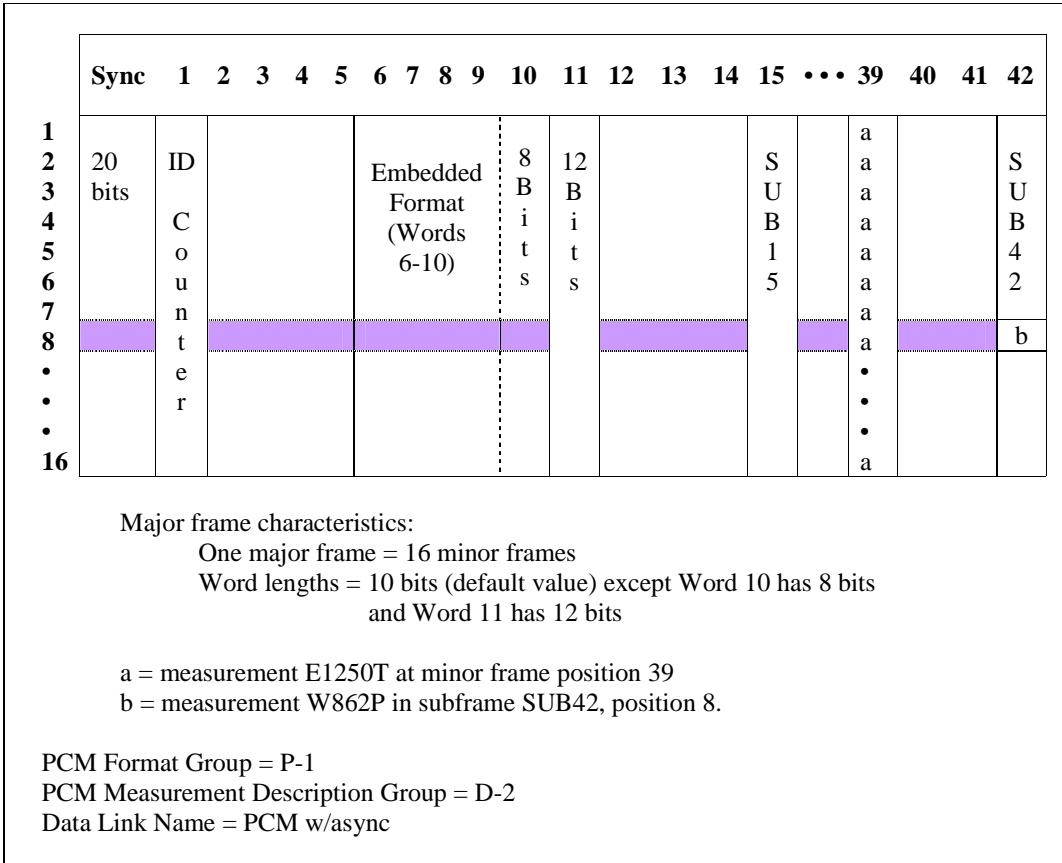

Figure J-2. PCM format for PCM w/async.

	<b>Sync</b>	<b>1</b>	<b>2</b>	<b>3</b>	<b>...</b>	<b>12</b>	<b>13</b>	<b>14</b>	<b>...</b>	<b>113</b>	<b>114</b>	<b>...</b>	<b>120</b>	<b>121</b>	<b>122</b>	<b>...</b>	<b>276</b>	
<b>1</b>							ID C o u n t e r			SUB 113				SUB 121				
<b>2</b>																		
<b>3</b>	30 bits																	
<b>4</b>																		
<b>5</b>										M				L				
<b>...</b>																		
<b>...</b>																		
<b>32</b>														6 Bits	4 Bits			
<b>...</b>																		
<b>...</b>																		
<b>37</b>										M				L				
<b>...</b>																		
<b>...</b>																		
<b>64</b>																		

Major frame characteristics:

One major frame = 64 minor frames

Subframes SUB113 and SUB121 are 32 deep

ID counter counts 0 - 63

Word lengths = 10 (default value) except Word 121 has 6 bits  
and Word 122 has 4 bits

Measurement 82AJ01 is 16 bits, which is fragmented with the 10 most significant bits indicated as M and the 6 least significant bits as L.

The measurement is located in position 5 of subframes SUB113 and SUB121 (minor frames 5 and 37 of the major frame).

PCM Format Group = P-2

PCM Measurement Description Group = D-3

Data Link Name = PCM1

Figure J-3. PCM format for PCM1.

		Sync	1	2	3	...	11	...	14	...	20	...	29	...	33	...	39	...	45	46	47	48	49	
16 B i t s	ID C o u n t e r	a	b	...	a	...	c	...	a	...	a	...	a	...	a	...	a	...	ASUB1		a			
		a	ASUB1	...	a	...	ASUB2	...	a	...	a	...	a	...	a	...	c	ASUB2	...	ASUB2		a		
		a	ASUB1	...	a	...	ASUB3	...	a	...	a	...	a	...	a	...	a	...	ASUB3	...	d		a	

Major frame characteristics:  
 One major frame = 3 minor frames  
 Word lengths = 16 bits (default value)

a = measurement J971U, supercommutated at positions 2, 11, 20, 29, 33, and 47  
 b = measurement J951V in subframe ASUB1, position 1  
 c = measurement J896D in supercommutated subframe ASUB3, positions 1 and 4  
 d = measurement J966X in subframe ASUB2, position 3

PCM Format Group = P-3  
 PCM Measurement Description Group = D-1  
 Data Link Name = ASYNC

Figure J-4. PCM format for async.

(Start of P-1)

Live PCM signal (host wave train) : Class I

P-1\DLN:PCM w/async; P-1\D1:NRZ-L; P-1\D2:44000; P-1\D3:U;  
 P-1\D4:N; P-1\D6:N; P-1\D7:N; P-1\TF:ONE;

10 bits default word length, 16 minor frames/major frame, 43 words/frame

P-1\F1:10; P-1\F2:M; P-1\F3:NO; P-1\MF\N:16; P-1\MF1:43;  
 P-1\MF2:440; P-1\MF3:FPT; P-1\MF4:20;  
 P-1\MF5: 01111010011010110001; P-1\SYNC1:1; P-1\SYNC2:0;  
 P-1\SYNC3:1;P-1\SYNC4:0;

Word position #10, 8 bits,  
 Word position #11, 12 bits

P-1\MFW1-1:10; P-1\MFW2-1:8; P-1\MFW1-2:11; P-1\MFW2-2:12;

*One subframe ID counter*

P-1\ISF\N:1; P-1\ISF1-1:1; P-1\ISF2-1:ID; P-1\IDC1-1:1;

*ID counter word length : 10 bits,  
MSB starting bit location : 7,  
ID counter length : 4*

P-1\IDC2-1:10; P-1\IDC3-1:7; P-1\IDC4-1:4; P-1\IDC5-1:M;  
P-1\IDC6-1:0; P-1\IDC7-1:1; P-1\IDC8-1:15; P-1\IDC9-1:16;  
P-1\IDC10-1:INC;

*Subframe definition  
SUB42 is located at 42, SUB15 at 15.  
All have depth 16.*

P-1\SF\N-1:2;

P-1\SF1-1-1:SUB42; P-1\SF2-1-1:NO;  
P-1\SF4-1-1-1:42; P-1\SF6-1-1:16;  
P-1\SF1-1-2:SUB15; P-1\SF2-1-2:NO;  
P-1\SF4-1-2-1:15; P-1\SF6-1-2:16;

*Asynchronous embedded wave train information*

*Data Link Name (to be referenced in the format definition of the asynchronous wave train) is ASYNC.*

*Five contiguous minor frame word positions starting at location 6.*

P-1\AEF\N:1; **P-1\AEF\DLN-1:ASYNC**; P-1\AEF1-1:5; P-1\AEF2-1:CW;  
P-1\AEF3-1-1:6;

*(End of P-1)*

---

*(Start of P-2)*

*Recorded PCM signal format attributes.*

*Data Link Name is PCMI, Data Format is NRZ-L, Bit rate is 2 Mbit/sec,  
Unencrypted, Normal polarity, class I, Common word length is 10, MSB first, No  
parity, 64 minor frames per major frame, 277 words per minor frame, Sync pattern  
length is 30. Word position 121 is 6 bits. Word position 122 is 4 bits.*

**P-2\DLN:PCM1**;P-2\D1:NRZ-L; P-2\D2:2000000; P-2\D3:U; P-2\D4:N;  
P-2\TF:ONE; P-2\F1:10; P-2\F2:M; P-2\F3:NO; P-2\MF\N:64;  
P-2\MF1:277; P-2\MF4:30; P-2\MF5:101110000001100111110101101011; P-2\SYNC1:1; P-  
2\MFW1-1:121; P-2\MFW2-1:6; P-2\MFW1-2:122;  
P-2\MFW2-2:4;

*Subframe characteristics:*

*One subframe ID counter named 1. Sync type is ID counter. ID counter location is 13. ID counter word length is 10. ID counter MSB location is 5. ID counter length is 6. ID counter transfer order is MSB first. ID counter initial value is 0. ID counter initial subframe is 1. ID counter end value is 63. ID counter end subframe is 64. ID counter is increasing.*

*Two subframes. First subframe name is SUB121. Not supercommutated, subframe location = word position 121, depth = 32. Second subframe name is SUB113. Not supercommutated, location = 113, depth = 32.*

P-2\ISF\N:1; P-2\ISF1-1:1; P-2\ISF2-1:ID; P-2\IDC1-1:13;  
P-2\IDC2-1:10; P-2\IDC3-1:5; P-2\IDC4-1:6; P-2\IDC5-1:M;  
P-2\IDC6-1:0; P-2\IDC7-1:1; P-2\IDC8-1:63; P-2\IDC9-1:64;  
P-2\IDC10-1:INC; P-2\SF\N-1:2; P-2\SF1-1-1:SUB121;  
P-2\SF2-1-1:NO; P-2\SF4-1-1-1:121; P-2\SF6-1-1:32;  
P-2\SF1-1-2:SUB113; P-2\SF2-1-2:NO; P-2\SF4-1-2-1:113;  
P-2\SF6-1-2:32;

*(End of P-2)*

---

*(Start of P-3)*

*Asynchronous wave train PCM format attributes.*

*Data Link Name: ASYNC*

*Class I, Common word length: 16, LSB transfer order, no parity, 3 minor frames per major frame, 50 words/minor frame, 800 bits per minor frame, fixed pattern synchronization, 16 bit sync pattern.*

**P-3\DLN:ASYNC**; P-3\TF:ONE; P-3\F1:16; P-3\F2:L; P-3\F3:NO;  
P-3\MF\N:3; P-3\MF1:50; P-3\MF2:800; P-3\MF3:FPT; P-3\MF4:16;  
P-3\MF5: 1111100110110001; P-3\SYNC1:1;

*Subframe definition.*

*Three subframes with ID counter word length 16 at word position 1.*

P-3\ISF\N:1; P-3\ISF1-1:2; P-3\ISF2-1:ID; P-3\IDC1-1:1;  
P-3\IDC2-1:16; P-3\IDC3-1:15; P-3\IDC4-1:2; P-3\IDC5-1:L;  
P-3\IDC6-1:0; P-3\IDC7-1:1; P-3\IDC8-1:2; P-3\IDC9-1:3;  
P-3\IDC10-1:INC;

*ASUB1 is at word position 3.*

*ASUB2 is at word position 45.*

*ASUB3 is supercommutated at word positions 14 and 39.*

P-3\SF\N-1:3; P-3\SF1-1-1:ASUB1; P-3\SF2-1-1:NO; P-3\SF3-1-1:NA;  
P-3\SF4-1-1-1:3; P-3\SF6-1-1:3; P-3\SF1-1-2:ASUB2;  
P-3\SF2-1-2:NO; P-3\SF3-1-2:NA; P-3\SF4-1-2-1:45; P-3\SF6-1-2:3;  
P-3\SF1-1-3:ASUB3; P-3\SF2-1-3:2; P-3\SF3-1-3:EL;  
P-3\SF4-1-3-1:14; P-3\SF4-1-3-2:39; P-3\SF6-1-3:3;

*(End of P-3)*

---

*(Start of P-4)*

**P-4\DLN:SPI;**

*(End of P-4)*

---

*PCM Measurement Description (D)*

*D-1 contains the measurements which make up the asynchronous wave train,*

*D-2 contains the measurements which make up the live PCM signal (which hosts the asynchronous wave train),*

*D-3 contains the measurements which make up one of the recorded PCM signals, and*

*D-4 contains the measurements which make up the other recorded PCM signal.*

---

*(Start of D-1)*

*Asynchronous Wave Train: One measurement list, 4 measurements*

**D-1\DLN:ASYNC; D-1\ML\N:1; D-1\MLN-1:JUST ONE; D-1\MN\N-1:4;**

*Measurement Name : J896D, LSB first,*

*Subframe supercommutated, 2 locations: 1 and 4 of ASUB3.*

**D-1\MN-1-1:J896D**; D-1\MN3-1-1:L; D-1\LT-1-1:SFSC;  
D-1\SFS1-1-1:ASUB3; D-1\SFS\N-1-1:2; D-1\SFS2-1-1:E;  
D-1\SFS6-1-1-1:1; D-1\SFS6-1-1-2:4; D-1\SFS7-1-1-1:FW;  
D-1\SFS7-1-1-2:FW;

*Measurement Name: J951V, LSB first, default parity, subframe ASUB1, location 1.*

**D-1\MN-1-2:J951V**; D-1\MN1-1-2:DE; D-1\MN2-1-2:D; D-1\MN3-1-2:L; D-1\LT-1-2:SF;  
D-1\SF2-1-2:1; D-1\SFM-1-2:1111111100000000;  
D-1\SF1-1-2:ASUB1;

*Measurement Name : J971U, LSB first,  
supercommutated at positions 2, 11, 20, 29, 33, and 47.*

**D-1\MN-1-3:J971U**; D-1\MN1-1-3:DE; D-1\MN2-1-3:D; D-1\MN3-1-3:L;  
D-1\LT-1-3:MFSC; D-1\MFS\N-1-3:6; D-1\MFS1-1-3:E;  
D-1\MFSW-1-3-1:2; D-1\MFSW-1-3-2:11; D-1\MFSW-1-3-3:20;  
D-1\MFSW-1-3-4:29; D-1\MFSW-1-3-5:33; D-1\MFSW-1-3-6:47;

*Measurement Name : J966X, LSB first, subframe ASUB2, location 3.*

**D-1\MN-1-4:J966X**; D-1\MN1-1-4:DE; D-1\MN2-1-4:D;  
D-1\MN3-1-4:L; D-1\LT-1-4:SF; D-1\SF1-1-4:ASUB2;  
D-1\SF2-1-4:3; D-1\SFM-1-4:FW;

*(End of D-1)*

---

*(Start of D-2)*

*Live PCM signal: single measurement list, 2 measurements.*

**D-2\DLN:PCM w/async**; D-2\MLN-1:JUST ONE; D-2\MN\N-1:2;

*Measurement name: E1250T, unclassified, unsigned, MSB first.*

**D-2\MN-1-1:E1250T**; D-2\MN1-1-1:DE; D-2\MN2-1-1:D;  
D-2\MN3-1-1:M; D-2\LT-1-1:MF; D-2\MF-1-1:39; D-2\MFM-1-1:FW;

*Measurement name: W862P, unclassified, MSB first,  
subframe name: SUB42, location 8 in subframe, full word.*

**D-2\MN-1-2:W862P**; D-2\MN1-1-2:DE; D-2\MN2-1-2:D; D-2\MN3-1-2:M; D-2\LT-1-2:SF;  
D-2\SF1-1-2:SUB42; D-2\SF2-1-2:8; D-2\SFM-1-2:FW;

(End of D-2)

---

(Start of D-3)

*Recorded PCM signal: single measurement list: 1 measurement.*

**D-3\DLN:PCM1**; D-3\MLN-1:ONLY ONE; D-3\MN\N-1:1;

*Measurement name: 82AJ01, subframe fragmented, 2 fragments,  
subframes: SUB113 and SUB121, subframe location: 5.*

**D-3\MN-1-1:82AJ01**; D-3\LT-1-1:SFFR; D-3\FSF\N-1-1:2;  
D-3\FSF1-1-1:16; D-3\FSF2\N-1-1:2; D-3\FSF3-1-1-1:SUB113;  
D-3\FSF3-1-1-2:SUB121; D-3\FSF4-1-1-1:E; D-3\FSF8-1-1-1:5;

(End of D-3)

---

(Start of D-4)

Recorded PCM signal

**D-4\DLN:SPI**;

(End of D-4)

---

#### Data Conversion Groups (C)

*C-1 and C-2 are measurements which are part of the live PCM signal (see also D-2).*

*C-3, C-4, C-5, and C-6 are from the asynchronous wave train (see also D-1).*

*C-7 is from the recorded PCM signal (see also D-3).*

*Measurement: E1250T, description: Inlet Temp Bellmouth, units: Deg C, binary format: unsigned; high value: 128, low value: -0.4, conversion type: pair sets, number of pair sets: 2, application (polynomial) : Yes; order of fit: 1, telemetry value #1: 0, engineering unit value #1: -0.4, telemetry value #2: 1023, engineering unit value #2: 128.*



**C-1\DCN:E1250T**; C-1\MN1:Inlet Temp Bellmouth; C-1\MN3:DEGC;  
C-1\BFM:UNS; C-1\MOT1:128; C-1\MOT2:-0.4; C-1\DCT:PRS;  
C-1\PS\N:2; C-1\PS1:Y; C-1\PS2:1; C-1\PS3-1:0; C-1\PS4-1:-0.4;  
C-1\PS3-2:1023; C-1\PS4-2:128;

*Measurement: W862P, description: Fuel Pump Inlet, binary format: unsigned; conversion type: pair sets, number of pair sets: 2, application (polynomial): Yes; order of fit: 1, telemetry value #1: 0, engineering unit value #1: -0.1 telemetry value #2: 1023, engineering unit value #2: 76.7*

**C-2\DCN:W862P**; C-2\MN1:Fuel Pump Inlet; C-2\BFM:UNS;  
C-2\DCT:PRS; C-2\PS\N:2; C-2\PS1:Y; C-2\PS2:1; C-2\PS3-1:0;  
C-2\PS4-1:-0.1; C-2\PS3-2:1023; C-2\PS4-2:76.7;

*Measurement: J896D, description: Terrian Altitude, units: Feet, binary format: two's complement; high value: 32768, low value: -32768, conversion type: pair sets; number of pair sets: 2, application (polynomial): Yes, order of fit: 1, telemetry value #1: -32768, engineering unit value #1: -32768, telemetry value #2: 32767, engineering unit value #2: 32767*

**C-3\DCN:J896D**; C-3\MN1:Terrian Altitude; C-3\MN3:FEET;  
C-3\BFM:TWO; C-3\MOT1:32768; C-3\MOT2:-32768; C-3\DCT:PRS;  
C-3\PS\N:2; C-3\PS1:Y; C-3\PS2:1; C-3\PS3-1:-32768;  
C-3\PS4-1:-32768; C-3\PS3-2:32767; C-3\PS4-2:32767;

*Measurement: J951V, description: Throttle Command, units: VDC, high value: 10.164, low value: -10.164, conversion type: pair sets, number of pair sets: 2, application (polynomial): Yes, order of fit: 1, telemetry value #1: -128, engineering unit value #1: -10.164, telemetry value #2: 127, engineering unit value #2: 10.164, binary format: two's complement*

**C-4\DCN:J951V**; C-4\MN1:Throttle Command; C-4\MN3:VDC;  
C-4\MOT1:10.164; C-4\MOT2:-10.164; C-4\DCT:PRS; C-4\PS\N:2;  
C-4\PS1:Y; C-4\PS2:1; C-4\PS3-1:-128; C-4\PS4-1:-10.164;  
C-4\PS3-2:127; C-4\PS4-2:10.164; C-4\BFM:TWO;

*Measurement: J971U; description: DISC, conversion type: discrete, binary format: unsigned.*

**C-5\DCN:J971U**; C-5\MN1:DISC; C-5\DCT:DIS; C-5\BFM:UNS;

*Measurement: J966X; description: Discrete, conversion type: discrete, binary format: unsigned.*

**C-6\DCN:J966X**; C-6\MN1:Discrete; C-6\DCT:DIS; C-6\BFM:UNS;

*Measurement: 82AJ01, description: LANTZ Norm acceleration,  
units: MTR/S/S, High value: 1023.97, Low value: -1023.97,  
conversion type: Coefficients  
Order of curve fit: 1, derived from pair sets: No,  
Coefficient (0): 0, Coefficient(1): 0.03125, binary format: two's complement*

**C-7\DCN:82AJ01;** C-7\MN1:LANTZ Norm acceleration; C-7\MN3:MTR/S/S;  
C-7\MOT1:1023.97; C-7\MOT2:-1023.97; C-7\DCT:COE; C-7\CO\N:1;  
C-7\CO1:N; C-7\CO:0; C-7\CO-1:.03125; C-7\BFM:TWO;

## APPENDIX K

### PULSE AMPLITUDE MODULATION STANDARDS

#### 1.0 General

This standard defines the recommended pulse train structure and design characteristics for the implementation of PAM telemetry systems. The PAM data are transmitted as time division multiplexed analog pulses with the amplitude of the information channel pulse being the analog-variable parameter.

#### 2.0 Frame and Pulse Structure

Each frame consists of a constant number of time-sequenced channel intervals. The maximum shall be 128 channel time intervals per frame, including the intervals devoted to synchronization and calibration. The pulse and frame structure shall conform to either Figure [K-1](#) or [K-2](#).

2.1 Commutation Pattern. The information channels are allocated equal and constant time intervals within the PAM frame. Each interval ("T" in Figures [K-1](#) and [K-2](#)) contains a sample pulse beginning at the start of the interval and having amplitude determined by the amplitude of the measurand of the corresponding information channel according to a fixed relationship (usually linear) between the minimum level (zero amplitude) and the maximum level (full-scale amplitude). For a 50-percent duty cycle (RZ-PAM), the zero level shall be 20 to 25 percent of the full amplitude level as shown in Figure K-1. The pulse width shall be the same in all time intervals except for the intervals devoted to synchronization. The duration shall be either  $0.5T \pm 0.05$ , as shown in Figure [K-1](#), or  $T \pm 0.05$ , as shown in Figure [K-2](#).

2.2 In-Flight Calibration. It is recommended that in-flight calibration be used and channels 1 and 2, immediately following the frame synchronization interval, be used for zero and full-scale calibration. For RZ-PAM, channel 3 may be used for an optional half-scale calibration, and for NRZ-PAM, the channel interval preceding channel 1 may be used for half-scale calibration if set to 50 percent.

2.3 Frame Synchronization Interval. Each frame is identified by the presence within it of a synchronization interval.

2.3.1 Fifty Percent Duty Cycle (RZ-PAM). The synchronization pattern interval shall have a duration equal to two information channel intervals ( $2T$ ) and shall be full-scale amplitude for  $1.5T$  followed by the reference level or zero baseline for  $0.5T$  (see Figure K-1).

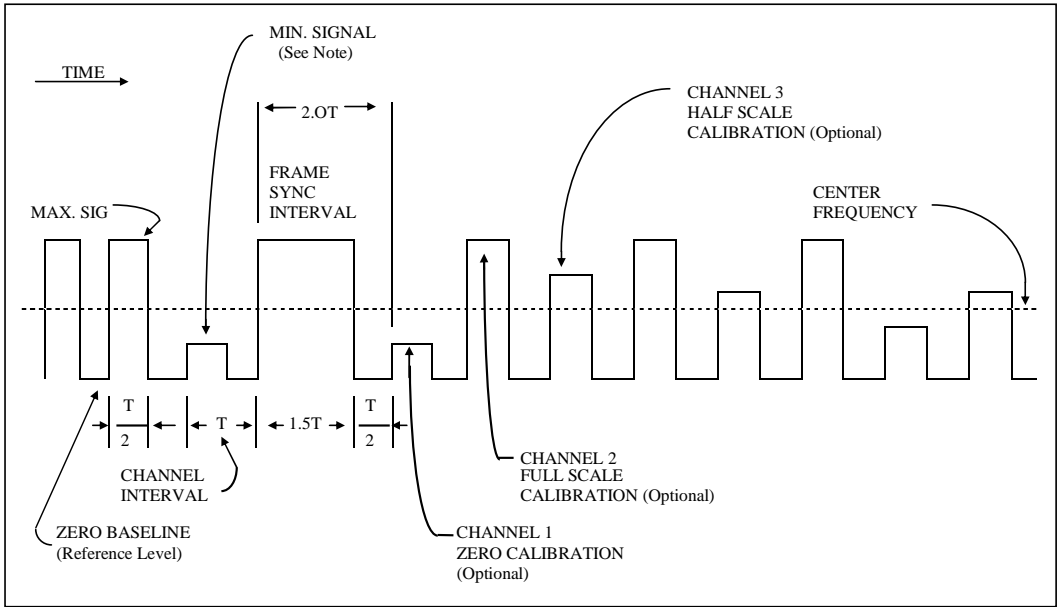

Figure K-1. 50-percent duty cycle PAM with amplitude synchronization.



A 20-25 percent deviation reserved for pulse synchronization is recommended.

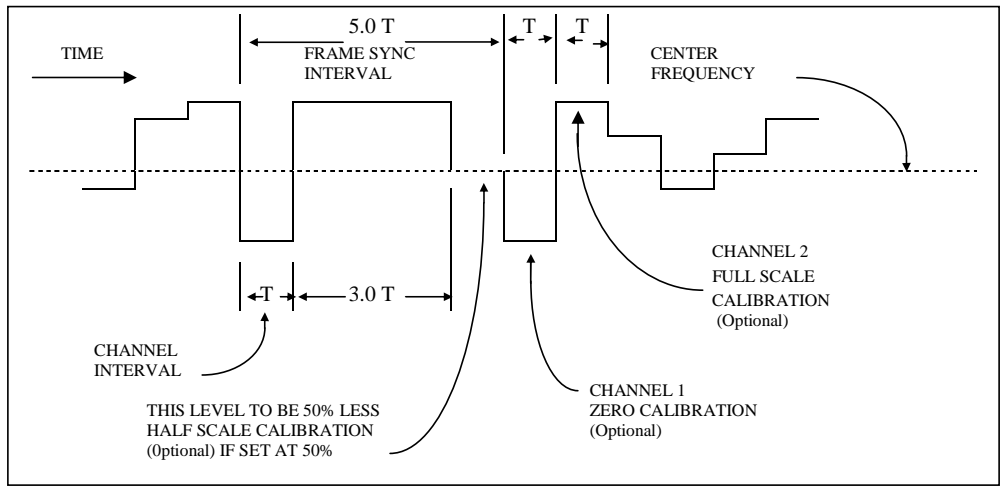

Figure K-2. 100-percent duty cycle PAM with amplitude synchronization.

2.3.2 One Hundred Percent Duty Cycle (NRZ-PAM). The synchronization pattern is in the order given: zero level for a period of T, full-scale amplitude for a period of 3T, and a level not exceeding 50-percent full-scale amplitude for a period T (see Figure [K-2](#)).

2.4 Maximum Pulse Rate. The maximum pulse rate should not be greater than that permitted by the following subparagraphs.

2.4.1 PAM/FM/FM. The reciprocal of the shortest interval between transitions in the PAM pulse train shall not be greater than one-fifth of the total (peak-to-peak) deviation specified in Chapter 3 and Tables [3-1](#)(A,B,C) and [3-2](#) for the FM subcarrier selected.

2.4.2 PAM/FM. The reciprocal of the shortest interval between transitions in the PAM pulse train shall be limited by whichever is the narrower of the following:

2.4.2.1 One-half of the 3-dB frequency of the premodulation filter when employed.

2.4.2.2 One-fifth of the intermediate frequency (IF) bandwidth (3 dB points) selected from the IF bandwidths which are listed in Table [2-2](#).

### 3.0 **Frame and Pulse Rate**

The frame and pulse parameters listed below may be used in any combination:

- a minimum rate of 0.125 frames per second, and
- a maximum pulse rate as specified in subparagraph 2.1.4.

3.1 Long Term Accuracy and Stability. During a measured period of desired data, the time between the occurrence of corresponding points in any two successive frame synchronization intervals should not differ from the reciprocal of the specified nominal frame rate by more than 5 percent of the nominal period.

3.2 Short Term Stability. During a measured period (P), containing 1000-channel intervals, the time between the start of any two successive channel intervals (synchronization intervals excepted) should not differ from the average channel interval established by the formula

$$T_{avg} = \frac{P}{1000}$$

by more than 1 percent of the average interval.

3.3 Multiple and Submultiple Sampling Rates. Data multiplexing at sampling rates which are multiples and submultiples of the frame rate is permissible.

3.3.1 Submultiple Frame Synchronization. The beginning of the longest submultiple frame interval is identified by the transmission of a synchronization pattern. All other submultiple frames have a fixed and known relationship to the identified submultiple frames.

3.3.1.1 Fifty Percent Duty Cycle (RZ). The synchronization pattern has a full-scale amplitude pulse in two successive occurrences of channel intervals allocated to data channels of the identified submultiple frame. The first such pulse has a duration equal to the channel interval; the second pulse immediately follows the first pulse and has a duration nominally one-half the channel interval. There is no return to zero between the two pulses.

3.3.1.2 One Hundred Percent Duty Cycle (NRZ). The synchronization pattern has information in five successive occurrences of a channel interval allocated to data channels of the identified submultiple frame. The amplitude of the data channels assigned for synchronization is shown in the following subparagraphs.

3.3.1.2.1 First occurrence - zero amplitude.

3.3.1.2.2 Second, third, and fourth occurrences - full-scale amplitude.

3.3.1.2.3 Fifth occurrence - not more than 50 percent of full-scale amplitude.

3.3.2 Maximum Submultiple Frame Length. The interval of any submultiple frame, including the time devoted to synchronizing information, shall not exceed 128 times the interval of the frame in which it occupies a recurring position.

#### **4.0 Frequency Modulation**

The frequency deviation of an FM carrier or subcarrier, which represents the maximum and minimum amplitude of a PAM waveform, should be equal and opposite with respect to the assigned carrier or subcarrier frequency. The deviation should be the same for all occurrences of the same level.

#### **5.0 Premodulation Filtering**

A maximally linear phase response, premodulation filter, is recommended to restrict the radiated spectrum (see [Appendix A](#)).

## APPENDIX L

### ASYNCHRONOUS RECORDER MULTIPLEXER OUTPUT RE-CONSTRUCTOR (ARMOR)

#### 1.0 General

This standard defines the recommended multiplexer format for single channel data recording on small format (1/2 in.) media (Section 6.17). This format is recognized as the Asynchronous Recorder Multiplexer Output Re-constructor (ARMOR). This format is software-reconfigurable for each data acquisition or reproduction. The ARMOR format configuration information is stored in a data structure called a "setup" that contains all the information necessary to define a particular record or play configuration. This appendix describes the format and content of the ARMOR setup.

1.1 Setup on Tape. When the ARMOR setup is written to tape, it is preceded by a preamble with a unique setup sync pattern that allows the identification of the setup. Three duplicate setup records, each with its own preamble, are written at the beginning of each recording. The format of the preamble is defined in Table L-1.

TABLE L-1. ARMOR SETUP PREAMBLE

FIELD	LENGTH	DESCRIPTION
SETUP SYNC	4 TAPE BLOCKS	THE SYNC PATTERN CONSISTS OF TWO BYTES. THE HIGH BYTE IS 0XE7; THE LOW BYTE IS 0X3D. THE SYNC PATTERN IS WRITTEN HIGH BYTE FIRST. FOR THE DCRSI, A TAPE BLOCK IS A SINGLE SCAN (4356 BYTES). FOR THE VLDS, A TAPE BLOCK IS A PRINCIPLE BLOCK (65536 BYTES).
END OF SYNC	3 BYTES	THE THREE BYTES IMMEDIATELY FOLLOWING THE SYNC PATTERN ARE: 0X45, 0X4F, 0X53 (ASCII 'E', 'O', 'S' FOR "END OF SYNC").

## 2.0 Setup Organization

An ARMOR setup is divided into three sections: the header section, the channel section, and the trailer section. The overall organization of a setup is summarized in Table [L-2](#).

TABLE L-2. SETUP ORGANIZATION	
CONTENT	NUMBER OF BYTES
HEADER SECTION	70
CHANNEL 1 INFORMATION	51 - 61
CHANNEL 2 INFORMATION	51 - 61
“ “	“
“ “	“
TRAILER SECTION	0 - 44 + SAVED SCANLIST SIZE

2.1 Header Section. The header section is the first 70 bytes of a setup. It contains information about the setup as a whole, including clock parameters, frame parameters, and the numbers of input and output channels (see Table [L-3](#)).



**NOTE**

In Tables L-3 through L-12, fields noted with an asterisk (\*) require user input per section 2.5.



**TABLE L-3. HEADER SECTION FORMAT**

<b>FIELD</b>	<b>BYTES</b>	<b>FORMAT</b>	<b>DESCRIPTION</b>
*SETUP LENGTH	2	BINARY	TOTAL BYTES IN SETUP, INCLUDING THIS FIELD
SOFTWARE VERSION	12	ASCII	VERSION OF THE ARMOR SETUP AND CONTROL SOFTWARE THAT WROTE THE SETUP
PRE-SCALERS	1	BINARY	THE BOTTOM FOUR BITS CONTAIN THE BIT RATE CLOCK PRE-SCALER; THE TOP FOUR BITS CONTAIN THE PACER CLOCK PRE-SCALER.
RESERVED	26	N/A	N/A
*SETUP KEYS (BIT 0)	1	BINARY	IF BIT 0 (LSB) SET, SETUP CONTAINS SETUP DESCRIPTION IN TRAILER.
*SETUP KEYS (BITS 1, 2, & 3)			IF BIT 1 SET, SETUP CONTAINS CHECKSUM IN TRAILER. IF BIT 2 SET, SETUP IS SCAN-ALIGNED. IF BIT THREE SET THEN A SCAN LIST IS SAVED.
PACER DIVIDER	2	BINARY	PACER DIVIDER VALUE
BIT RATE	4	BINARY	AGGREGATE BIT RATE FOR ALL ENABLED CHANNELS
BRC DIVIDER	2	BINARY	BIT RATE CLOCK DIVIDER VALUE
MASTER OSCILLATOR	4	BINARY	FREQUENCY OF THE MASTER OSCILLATOR IN BITS PER SECOND
BYTES OVERHEAD	4	BINARY	TOTAL SYNC BYTES PLUS FILLER BYTES PER FRAME.
PACER	4	BINARY	FREQUENCY OF THE PACER CLOCK IN CYCLES PER SECOND
FRAME RATE	4	BINARY	NUMBER OF FRAMES PER SECOND
*INPUT COUNT	2	BINARY	NUMBER OF INPUT CHANNELS IN SETUP
OUTPUT COUNT	2	BINARY	NUMBER OF OUTPUT CHANNELS IN SETUP

2.2 Channel Section. The channel section contains one channel entry for every channel in the multiplexer chassis configuration, including those channels that are not enabled or recorded. The content and length of the channel information vary depending on the channel type. The lengths of the channel entries for each channel type are presented in Table L-4. Tables L-5 through L-14 describe the channel entry fields for each module type.

<b>TABLE L-4. CHANNEL ENTRY LENGTHS</b>	
<b>CHANNEL TYPE</b>	<b>BYTES</b>
PCM INPUT AND OUTPUT	51
ANALOG INPUT AND OUTPUT	53
PARALLEL INPUT	53
PARALLEL OUTPUT	56
TIMECODE INPUT AND OUTPUT	61
VOICE INPUT AND OUTPUT	61
BIT SYNC INPUT	61

**TABLE L-5. PCM INPUT CHANNELS**

<b>FIELD</b>	<b>BYTES</b>	<b>FORMAT</b>	<b>DESCRIPTION</b>
*CHANNEL TYPE	2	BINARY	1 = 8 BIT PCM INPUT 8 = 20 MBIT PCM INPUT
MAPPED CHANNEL	2	BINARY	INDEX OF THE CHANNEL THIS CHANNEL IS MAPPED TO. IF THE CHANNEL IS NOT MAPPED, THE INDEX IS -1.
*ENABLED	1	ASCII	IF ENABLED, THE CHANNEL IS RECORDED ("Y" OR "N")
ACTUAL RATE	4	BINARY	ACTUAL WORD RATE IN WORDS PER SECOND
WORDS PER FRAME	4	BINARY	NUMBER OF WORDS PER FRAME
INPUT MODES	1	BINARY	IF BIT 0 (LSB) SET, SOURCE B DATA; ELSE SOURCE A. IF BIT 1 SET, NRZ-L; ELSE BI-PHASE-L. IF BIT 2 SET, 0 DEGREE CLOCK; ELSE 90 DEGREE CLOCK.
RESERVED	3	N/A	N/A
BITS PER WORD	2	BINARY	16 BITS
BITS PRECEDING	4	BINARY	NUMBER OF BITS IN THE FRAME THAT MUST PRECEDE THIS CHANNEL
*CHANNEL NUMBER	2	BINARY	CHANNEL ON MODULE (0-3)
*MODULE ID	1	BINARY	MODULE ID = HEX 11
RESERVED	1	N/A	N/A
*REQUESTED RATE	4	BINARY	REQUESTED BITS PER SECOND (INTEGER)
DESCRIPTION	20	ASCII	CHANNEL DESCRIPTION

**TABLE L-6. ANALOG INPUT AND OUTPUT CHANNELS**

<b>FIELD</b>	<b>BYTES</b>	<b>FORMAT</b>	<b>DESCRIPTION</b>
CHANNEL TYPE	2	BINARY	2 = 8 MBIT PCM OUTPUT 9 = 20 MBIT PCM OUTPUT
MAPPED CHANNEL	2	BINARY	INDEX OF THE CHANNEL THIS CHANNEL IS MAPPED TO. IF THE CHANNEL IS NOT MAPPED, THE INDEX IS -1.
ENABLED	1	ASCII	IF ENABLED, THE CHANNEL IS RECORDED ("Y" OR "N").
ACTUAL RATE	4	BINARY	ACTUAL WORD RATE IN WORDS PER SECOND
WORDS PER FRAME	4	BINARY	NUMBER OF WORDS PER FRAME
OUTPUT MODES	1	BINARY	IF BIT 0 (LSB) SET, BURST MODE. IF BIT 1 SET, BI-PHASE; ELSE NRZ-L.
RESERVED	3	N/A	N/A
BITS PER WORD	2	BINARY	NUMBER OF BITS PER WORD
BITS PRECEDING	4	BINARY	NUMBER OF BITS IN THE FRAME THAT MUST PRECEDE THIS CHANNEL
CHANNEL NUMBER	2	BINARY	CHANNEL ON MODULE (0-3)
MODULE ID	1	BINARY	MODULE ID = HEX 21
RESERVED	1	N/A	N/A
REQUESTED RATE	4	BINARY	REQUESTED BITS PER SECOND
DESCRIPTION	20	ASCII	CHANNEL DESCRIPTION

**TABLE L-7. ANALOG INPUT AND OUTPUT CHANNELS**

<b>FIELD</b>	<b>BYTES</b>	<b>FORMAT</b>	<b>DESCRIPTION</b>
*CHANNEL TYPE	2	BINARY	5 = LF ANALOG INPUT 6 = HF ANALOG INPUT 7 = ANALOG OUTPUT
MAPPED CHANNEL	2	BINARY	INDEX OF THE CHANNEL THIS CHANNEL IS MAPPED TO. IF THE CHANNEL IS NOT MAPPED, THE INDEX IS -1.
*ENABLED	1	ASCII	IF ENABLED, THE CHANNEL IS RECORDED ("Y" OR "N").
ACTUAL RATE	4	BINARY	ACTUAL SAMPLE RATE IN SAMPLES PER SECOND
SAMPLES PER FRAME	4	BINARY	NUMBER OR SAMPLES PER FRAME
FILTER NUMBER	1	BINARY	0 = FILTER 1 1 = FILTER 2 2 = FILTER 3 3 = FILTER 4
RESERVED	3	N/A	N/A
*BITS PER SAMPLE	2	BINARY	NUMBER OF BITS PER SAMPLE (8 OR 12)
RESERVED	4	N/A	N/A
*CHANNEL NUMBER	2	BINARY	CHANNEL ON MODULE (0-3)
*MODULE ID	1	BINARY	MODULE ID = 34 HEX (LF) OR 33 HEX (HF)
RESERVED	1	N/A	N/A
*REQUESTED RATE	4	BINARY	REQUESTED SAMPLES PER SECOND
RESERVED	2	N/A	N/A
DESCRIPTION	20	ASCII	CHANNEL DESCRIPTION

**TABLE L-8. PARALLEL INPUT CHANNELS**

<b>FIELD</b>	<b>BYTES</b>	<b>FORMAT</b>	<b>DESCRIPTION</b>
*CHANNEL TYPE	2	BINARY	13 = NEW PARALLEL INPUT
MAPPED CHANNEL	2	BINARY	INDEX OF THE CHANNEL THIS CHANNEL IS MAPPED TO. IF THE CHANNEL IS NOT MAPPED, THE INDEX IS -1.
*ENABLED	1	ASCII	IF ENABLED, THE CHANNEL IS RECORDED ("Y" OR "N").
ACTUAL RATE	4	BINARY	ACTUAL WORDS PER SECOND
WORDS PER FRAME	4	BINARY	NUMBER OF WORDS PER FRAME
RESERVED	4	N/A	N/A
BITS PER WORD	2	BINARY	NUMBER OF BITS PER WORD
WORDS PRECEDING	4	BINARY	NUMBER OF WORDS IN THE FRAME THAT MUST PRECEDE THIS CHANNEL
*CHANNEL NUMBER	2	BINARY	CHANNEL ON MODULE (0-3)
*MODULE ID	1	BINARY	MODULE ID = HEX 92
RESERVED	1	N/A	N/A
*REQUESTED RATE	4	BINARY	REQUESTED WORDS PER SECOND.
INPUT MODE	1	BINARY	0 = FOUR 8-BIT CHANNELS 1 = ONE 16-BIT, TWO 8-BIT (CURRENTLY UNAVAILABLE) 2 = TWO 16-BIT (CURRENTLY UNAVAILABLE) 3 = ONE 32-BIT (CURRENTLY UNAVAILABLE) 4 = ONE 24-BIT, ONE 8-BIT (CURRENTLY UNAVAILABLE)
RESERVED	1	N/A	N/A
DESCRIPTION	20	ASCII	CHANNEL DESCRIPTION

**TABLE L-9. PARALLEL OUTPUT CHANNELS**

<b>FIELD</b>	<b>BYTES</b>	<b>FORMAT</b>	<b>DESCRIPTION</b>
CHANNEL TYPE	2	BINARY	14 = NEW PARALLEL OUTPUT
MAPPED CHANNEL	2	BINARY	INDEX OF THE CHANNEL THIS CHANNEL IS MAPPED TO. IF THE CHANNEL IS NOT MAPPED, THE INDEX IS -1.
ENABLED	1	ASCII	IF ENABLED, THE CHANNEL IS RECORDED ("Y" OR "N").
ACTUAL RATE	4	BINARY	ACTUAL WORD RATE IN WORDS PER SECOND
WORDS PER FRAME	4	BINARY	NUMBER OF WORDS PER FRAME
RESERVED	4	N/A	N/A
BITS PER WORD	2	BINARY	NUMBER OF BITS PER WORD
WORDS PRECEDING	4	BINARY	NUMBER OF WORDS IN THE FRAME THAT MUST PRECEDE THIS CHANNEL
CHANNEL NUMBER	2	BINARY	CHANNEL ON MODULE (0-3)
MODULE ID	1	BINARY	MODULE ID = HEX A2
RESERVED	1	N/A	N/A
REQUESTED RATE	4	BINARY	REQUESTED WORDS PER SECOND
OUTPUT MODE	1	BINARY	0 = FOUR 8-BIT CHANNELS 1 = ONE 16-BIT, TWO 8-BIT 2 = TWO 16-BIT CHANNELS 3 = ONE 32-BIT CHANNEL 4 = ONE 24-BIT, ONE 8-BIT 7 = TWO 8-BIT DCRSI MODE
RECONSTRUCT MODE	1	BINARY	0 = DATA IS FROM MODULE OTHER THAN PARALLEL INPUT. 1 = DATA IS FROM PARALLEL INPUT. VALID ONLY FOR OUTPUT MODE.
DCRSI OUTPUT	1	BINARY	0 = HEADER AND DATA 1 = HEADER ONLY 3 = DATA VALID ONLY FOR OUTPUT MODE 7.

**TABLE L-9 (Cont'd). PARALLEL OUTPUT CHANNELS**

<b>FIELD</b>	<b>BYTES</b>	<b>FORMAT</b>	<b>DESCRIPTION</b>
BURST SELECT	1	BINARY	0 = CONSTANT 1 = BURST
HANDSHAKE SELECT	1	BINARY	0 = DISABLE HANDSHAKING 1 = ENABLE HANDSHAKING
DESCRIPTION	20	ASCII	CHANNEL DESCRIPTION



**TABLE L-10. TIME CODE INPUT CHANNELS**

FIELD	BYTES	FORMAT	DESCRIPTION
*CHANNEL TYPE	2	BINARY	TIME CODE MUST APPEAR AS A GROUP OF 3 CHANNELS, EVEN THOUGH THE USER INTERFACE ONLY DISPLAYS A SINGLE CHANNEL. THE RESPECTIVE TYPES ARE 15, 19, AND 20.
MAPPED CHANNEL	2	BINARY	INDEX OF THE CHANNEL THIS CHANNEL IS MAPPED TO. IF THE CHANNEL IS NOT MAPPED, THE INDEX IS -1.
*ENABLED	1	ASCII	“Y” OR “N”
ACTUAL RATE	4	BINARY	1
SAMPLES PER FRAME	4	BINARY	1
RESERVED	4	N/A	N/A
*BITS PER WORD	2	BINARY	24 FOR CHANNEL TYPE 15 24 FOR CHANNEL TYPE 19 16 FOR CHANNEL TYPE 20
RESERVED	4	N/A	N/A
*CHANNEL NUMBER	2	BINARY	0 FOR CHANNEL TYPE 15 1 FOR CHANNEL TYPE 19 2 FOR CHANNEL TYPE 20
*MODULE ID	1	BINARY	MODULE ID = HEX B1
RESERVED	1	N/A	N/A
*REQUEST SAMPLE RATE	4	BINARY	1
*BITS PER SAMPLE	2	BINARY	24 FOR CHANNEL TYPE 15 24 FOR CHANNEL TYPE 19 16 FOR CHANNEL TYPE 20
DESCRIPTION	20	ASCII	CHANNEL DESCRIPTION
RESERVED	4	N/A	N/A
TCI MODE	1	BINARY	0 = GENERATE TIME 1 = USE EXTERNAL IRIG SOURCE
RESERVED	3	N/A	N/A

**TABLE L-11. TIME CODE OUTPUT CHANNELS**

<b>FIELD</b>	<b>BYTES</b>	<b>FORMAT</b>	<b>DESCRIPTION</b>
CHANNEL TYPE	2	BINARY	TIME CODE MUST APPEAR AS A GROUP OF 3 CHANNELS, EVEN THOUGH THE USER INTERFACE ONLY DISPLAYS A SINGLE CHANNEL. THE RESPECTIVE TYPES ARE 17, 21 AND 22.
MAPPED CHANNEL	2	BINARY	INDEX OF THE CHANNEL THIS CHANNEL IS MAPPED TO. IF THE CHANNEL IS NOT MAPPED, THE INDEX IS -1.
ENABLED	1	ASCII	“Y” - ENABLED, OR “N” - DISABLED
ACTUAL RATE	4	BINARY	1
SAMPLES PER FRAME	4	BINARY	1
RESERVED	4	N/A	N/A
BITS PER WORD	2	BINARY	24 FOR CHANNEL TYPE 17 24 FOR CHANNEL TYPE 21 16 FOR CHANNEL TYPE 22
RESERVED	4	N/A	N/A
CHANNEL NUMBER	2	BINARY	0 FOR CHANNEL TYPE 17 1 FOR CHANNEL TYPE 21 2 FOR CHANNEL TYPE 22
MODULE ID	1	BINARY	MODULE ID = HEX B1
RESERVED	1	N/A	N/A
REQUESTED SAMPLE RATE	4	BINARY	1
BITS PER SAMPLE	2	BINARY	24 FOR CHANNEL TYPE 17 24 FOR CHANNEL TYPE 21 16 FOR CHANNEL TYPE 22
DESCRIPTION	20	ASCII	CHANNEL DESCRIPTION
RESERVED	4	N/A	N/A
TCO MODE	1	BINARY	0 - GENERATE TIME 1 - USE TIME FROM RECORDED TAPE
RESERVED	3	N/A	N/A

**TABLE L-12. VOICE INPUT CHANNEL**

<b>FIELD</b>	<b>BYTES</b>	<b>FORMAT</b>	<b>DESCRIPTION</b>
*CHANNEL TYPE	2	BINARY	16
MAPPED CHANNEL	2	BINARY	INDEX OF THE CHANNEL THIS CHANNEL IS MAPPED TO. IF THE CHANNEL IS NOT MAPPED, THE INDEX IS -1.
*ENABLED	1	ASCII	“Y” - ENABLED, OR “N” - DISABLED
ACTUAL RATE	4	BINARY	ACTUAL SAMPLE RATE IN SAMPLES PER SECOND
SAMPLES PER FRAME	4	BINARY	NUMBER OF SAMPLES PER FRAME
RESERVED	4	N/A	N/A
*BITS PER WORD	2	BINARY	8
RESERVED	4	N/A	N/A
*CHANNEL NUMBER	2	BINARY	3
*MODULE ID	1	BINARY	MODULE ID = HEX B1
RESERVED	1	N/A	N/A
*REQUESTED SAMPLE RATE	4	BINARY	2K, 5K, 10K, 20K, 50K, OR 100K
*BITS PER SAMPLE	2	BINARY	8
DESCRIPTION	20	ASCII	CHANNEL DESCRIPTION
RESERVED	1	N/A	N/A
VOLTAGE GAIN	2	BINARY	0 - GAIN OF 1 1 - GAIN OF 2 2 - GAIN OF 4 3 - GAIN OF 8
RESERVED	5	N/A	N/A

**TABLE L-13. VOICE OUTPUT CHANNELS**

<b>FIELD</b>	<b>BYTES</b>	<b>FORMAT</b>	<b>DESCRIPTION</b>
CHANNEL TYPE	2	BINARY	18
MAPPED CHANNEL	2	BINARY	INDEX OF THE CHANNEL THIS CHANNEL IS MAPPED TO. IF THE CHANNEL IS NOT MAPPED, THE INDEX IS -1
ENABLED	1	ASCII	“Y” - ENABLED, OR “N” - DISABLED
ACTUAL RATE	4	BINARY	ACTUAL SAMPLE RATE IN SAMPLES PER SECOND
SAMPLES PER FRAME	4	BINARY	NUMBER OF SAMPLES PER FRAME
RESERVED	4	N/A	N/A
BITS PER WORD	2	BINARY	8
RESERVED	4	N/A	N/A
CHANNEL NUMBER	2	BINARY	3
MODULE ID	1	BINARY	MODULE ID = HEX B1
RESERVED	1	N/A	N/A
REQUEST SAMPLE RATE	4	BINARY	NUMBER OF SAMPLES PER SECOND
BITS PER SAMPLE	2	BINARY	8
DESCRIPTION	20	ASCII	CHANNEL DESCRIPTION
RESERVED	8	N/A	N/A

**TABLE L-14. BIT SYNC INPUT CHANNELS**

<b>FIELD</b>	<b>BYTES</b>	<b>FORMAT</b>	<b>DESCRIPTION</b>
CHANNEL TYPE	2	BINARY	23
RESERVED	2	N/A	N/A
ENABLED	1	ASCII	“Y” - ENABLED, OR “N” - DISABLED
ACTUAL RATE	4	BINARY	ACTUAL WORD RATE IN WORDS PER SECOND
WORDS PER FRAME	4	BINARY	NUMBER OR WORDS PER FRAME
RESERVED	4	N/A	N/A
BITS PER WORD	2	BINARY	16
RESERVED	4	N/A	N/A
CHANNEL NUMBER	2	BINARY	CHANNEL ON MODULE (0-3)
MODULE ID	1	BINARY	MODULE ID = HEXADECIMAL 13
RESERVED	1	N/A	N/A
REQUESTED RATE	4	BINARY	BITS PER SECOND
DESCRIPTION	20	ASCII	CHANNEL DESCRIPTION
INSTALLED	1	BINARY	0 = DAUGHTER BOARD NOT INSTALLED 1 = DAUGHTER BOARD INSTALLED
PCM GEOGRAPHICAL ADDRESS	1	BINARY	GEOGRAPHICAL ADDRESS OF THE ASSOCIATED PCM INPUT CHANNEL
SOURCE CLOCK	1	BINARY	0 = SOURCE A 1 = SOURCE B
RESERVED	7	N/A	N/A

2.3 Trailer Section. The trailer section contains the setup description and the checksum (see Table L-15). Early versions of the setup do not contain this information. The “Setup Keys” field in the header indicates the content of the trailer section.

TABLE L-15. TRAILER SECTION FORMAT			
FIELD	BYTES	FORMAT	DESCRIPTION
SETUP DESCRIPTION	40	ASCII	DESCRIPTION OF THE SETUP
SAVED SCANLIST	VARIES	BINARY	NUMBER OF BYTES DEPENDS ON THE NUMBER OF CHANNELS BEING RECORDED.
CHECKSUM	4	BINARY	SUM OF ALL SETUP BYTES

2.4 Saved Scan-list Structure. This is an array of enabled input channels that make up the calculated scan-list. Each element of the array is made up of two fields, an index field and a count field. The length of the index field is one byte, and the length of the count field is two bytes.

- The index field, which is 1-based, is determined by the position of the channel’s module in the ARMOR system. The first input channel found in the ARMOR system is assigned an index of 1, the next input channel is assigned a 2, and so on. The search for input modules starts at slot 1. Filler bytes are assigned an index value of 255.
- The count field is the number of words/samples per frame that is assigned to that input channel.

2.5 Creating a Setup Block. Creating a Setup Block involves two steps. In the first step, the user creates an “input” setup block file as described below in this section. Most of the fields in the input setup block file are unspecified (filled with zeros). In the second step, the input setup block file is read by the ARMOR compiler program that produces a new setup block file with all the unspecified fields initialized to the appropriate values. In other words, a setup block has two types of fields, user specified and compiler generated. Note that all compiler generated fields must be provided in the input setup block file and initialized with zeros prior to executing the ARMOR compiler program.

The rules presented in this section must be explicitly followed to create an ARMOR input setup block. Values for fields identified in the previous tables with an asterisk preceding the field name must be provided. In some cases the values for these required fields are constant and are specified in the tables above. In other cases, the user must provide the desired value. All

fields with names not identified with asterisks must be initialized to binary zero. This includes both “unused” and “reserved” fields.

Only input channel information entries are required. Output channel information entries are ignored by the ARMOR compiler program.

### 2.5.1 Header Section

Setup Length: Count the total numbers of bytes in the created setup block and put the value here.

Setup Keys: Set bit 0 = 1 if the trailer contains a description. Leave other bits = 0.

Input Count: Enter the total number of input channel information entries, including both enabled and disabled entries.

2.5.2 Channel Section. PCM, low frequency (LF) analog, and parallel input channel information entries must be included in the setup block in groups of four entries per type. High frequency (HF) analog input channel information entries must be included in the setup block in groups of two entries per type. Time code/voice input channel information entries must be included in groups of three time code entries and one voice entry. Specifying an ASCII “N” in the enabled field must disable all unused input channel information entries. For each channel information entry group, the channel number field of the first entry in the group is 0 (zero), the second entry is 1, the third is 2, and the fourth is 3. For the time code/voice group, the time code entry channel number fields are 0, 1, and 2, respectively, while the voice entry channel number field is 3. HF analog entry channel number fields are 0 and 1, respectively.

Description fields are not required and are not specified below. However, it is advisable to include an ASCII description of each channel for future reference.

#### 2.5.2.1 PCM Input Channels

Channel Type: Binary 8  
Enabled: ASCII “Y” if enabled, “N” if disabled  
Channel Number: Binary 0, 1, 2, or 3 as described in 2.5.2 above  
Module ID: Hexadecimal 11  
Requested Rate: Binary integer rate in bits per second

#### 2.5.2.2 Analog Input Channels

Channel Type: Binary 5 for LF (up to 1 megasample/sec), 6 for HF (up to 10 megasamples/sec)  
Enabled: “Y” if enabled, “N” if disabled  
Bits per Sample: 8 or 12

Channel Number: 0, 1, 2, or 3 as described in 2.5.2 above  
Module ID: Hexadecimal 34 (LF) or 33 (HF)  
Requested Rate: Binary integer 2K, 5K, 10K, 20K, 50K, 100K,  
200K, 500K, 1M (LF, HF) 2.5M, 5M, 10M (HF only)

#### 2.5.2.3 Parallel Input Channels.

Channel Type: Decimal 13  
Enabled: “Y” if enabled, “N” if disabled  
Channel Number: 0, 1, 2, or 3 as described in 2.5.2 above  
Module ID: Hexadecimal 92  
Requested Rate: Binary integer 8-bit words (bytes) per second

#### 2.5.2.4 Time Code Input Channels.

Channel Type: Decimal 15 (1<sup>st</sup> entry) , 19 (2<sup>nd</sup> entry), 20 (3<sup>rd</sup> entry)  
Enabled: “Y” if enabled, “N” if disabled, all three entries must be the same  
Bits per Word: Decimal 24 (1<sup>st</sup> entry), 24 (2<sup>nd</sup> entry), 16 (3<sup>rd</sup> entry)  
Channel Number: 0, 1, or 2 as described in 2.5.2 above  
Module ID: Hexadecimal B1  
Requested Rate: 1  
Bits per Sample: Decimal 24 (1<sup>st</sup> entry), 24 (2<sup>nd</sup> entry), 16 (3<sup>rd</sup> entry)

#### 2.5.2.5 Voice Input Channels.

Channel Type: Decimal 16  
Enabled: “Y” if enabled, “N” if disabled  
Bits per Word: 8  
Channel Number: 3 as described in 2.5.2 above  
Requested Rate: Integer 2K, 5K, 10K, 50K, 100K  
Bits per Sample: 8



2.5.3 Trailer Section. The trailer section of the input setup block is not required. The user may include an ASCII text setup description in the trailer section by setting the setup keys bit 0 = 1 in the header section (see section [2.5.1](#)) and adding the setup description field only in the trailer section.

2.5.4 ARMOR Compiler Program. Operational instructions for the ARMOR compiler program are provided in the readme.txt file provided with the compiler (see section [6.17.3.1](#)).

This page intentionally left blank.

## APPENDIX M

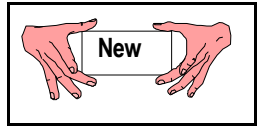

### 1.0 Introduction

This appendix summarizes a study of the differential encoder originally adopted by the U.S. Department of Defense (DoD) Advanced Range Telemetry (ARTM) project and the Range Commanders Council (RCC) and incorporated into the Interrange Instrumentation Group (IRIG) Standard 106 (IRIG-106) (reference [\[M-1\]](#)) for Feher's Quadrature Phase Shift Keying (FQPSK-B)<sup>48</sup> modulation. The study, performed by Mr. Robert Jefferis of the TYBRIN Corporation, was prompted by inquiries from industry representatives who were concerned that this particular differential code was not associated with commercial telecommunication standards and the fact that manufacturers had experienced confusion over correct implementation. The study results shown in this appendix prove the code to be robust, reliable, and applicable to Shaped Offset QPSK (SOQPSK-TG)<sup>49</sup> as well as FQPSK-B and FQPSK-JR.<sup>50</sup>

This appendix is organized along the following structure. Paragraph 2 describes the need for differential encoding. Paragraph 3 explains the IRIG-106 differential code for OQPSKs. Paragraph 4 demonstrates differential code's invariance with respect to constellation rotation. Paragraph 5 shows the differential decoder to be self-synchronizing. Paragraph 6 reviews the differential decoder's error propagation characteristics. Paragraph 7 analyzes a recursive implementation of the differential code and Paragraph 8 describes use of this code with frequency modulator based SOQPSK transmitters. A description of the implementation of the entire coding and decoding process can be seen at Annex 1 to this appendix.

### 2.0 The Need For Differential Encoding

Practical carrier recovery techniques like Costas loops and squaring loops exhibit a troublesome M-fold carrier phase ambiguity. A description of ambiguity problems and how to overcome them are shown in the following paragraphs of this appendix.

Shown below at Figure [M-1](#) is a simplified quadriphase transmission system that is one of the methods recommended for transparent point-to-point transport of a serial binary data stream. Transparent means that only revenue bearing data is transmitted. There is no in-line channel coding nor is special bit pattern insertion allowed. The assumption is made for a non-return-to-zero-level (NRZ-L) data stream containing the bit sequence  $b(nT_b)$  transmitted at rate  $r_b = 1/T_b$  bits per second. For QPSK and OQPSK modulations, the bit stream is divided into subsets "e" containing even numbered bits and "o" containing odd numbered bits. The transmission rate associated with

<sup>48</sup> FQPSK-B is a proprietary variation of "Offset" QPSK (OQPSK), Digcom Inc., El Macero, California.

<sup>49</sup> See [Chapter 2](#) and [Appendix-A](#) for details on SOQPSK-TG (formerly SOQPSK-A\*).

<sup>50</sup> FQPSK-JR is an FQPSK variant developed by Mr. Robert Jefferis, TYBRIN Corporation, and Mr. Rich Formeister, RF Networks, Inc.

the split symbol streams is  $r_s = r_b/2$  symbols per second. Symbol values are converted to code symbols by the differential encoder described in section 3.0 below. A baseband waveform generator converts the digital symbol time series into continuous time signals suitable for driving the vector modulator as prescribed for the particular modulation in use. Thus, each subset modulates one of two orthogonal subcarriers, the “in-phase” ( $I$ ) channel, and the “quadrature” ( $Q$ ) channel. The modulator combines these subcarriers, creating a phase modulated RF signal  $S(t)$ . On the receive side, demodulation separates the subcarriers, translates them back to baseband, and constructs replicas of the code symbol series  $E'(nT_s)$  and  $O'(nT_s)$ . Decoding reverses the encoding process and a multiplexer (MUX) recreates a replica of the bit stream  $b'(nT_b)$ .

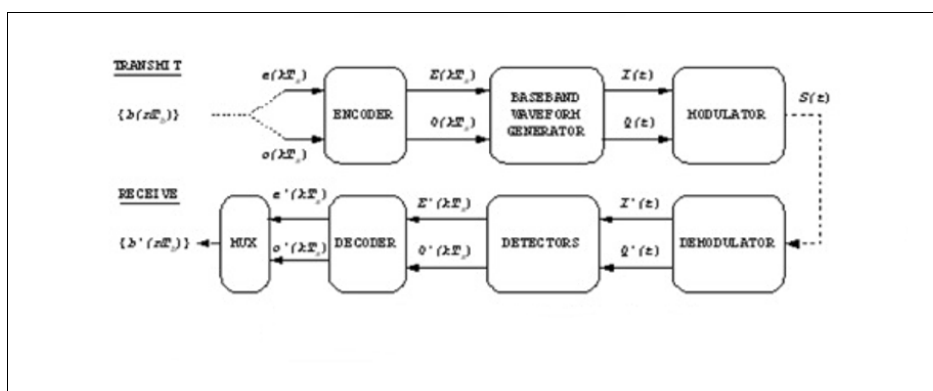

Figure M-1. Transmission System.

Most QPSK and OQPSK systems employ coherent demodulation. Figure M-2 is a simplified diagram of commonly used modulation and demodulation structures. Note the optional single bit delay shown in the odd symbol path. This creates the significant difference between QPSK and OQPSK, the delay being inserted to create OQPSK.<sup>51</sup> Practical carrier recovery techniques like Costas loops and squaring loops exhibit a troublesome  $M$ -fold phase ambiguity ( $M=4$  for QPSK and OQPSK) (see reference [M-2]). Each time the demodulator carrier synchronizer phase locks to the modulator local oscillator (LO) its absolute phase relationship to the LO contains the offset term  $\beta$  which can take on values of  $0, \pm \pi/2, \text{ or } \pi$  radians.<sup>52</sup>

<sup>51</sup> The delay can be inserted into either channel. The IRIG-106 convention and most published literature regarding FQPSK and SOQPSK indicate the delay in the odd (or Q) channel.

<sup>52</sup> The initial offset angle  $\phi$  is generally unknown and uncontrolled; it is tracked by the carrier recovery circuitry and the symbol timing circuits automatically ignore.

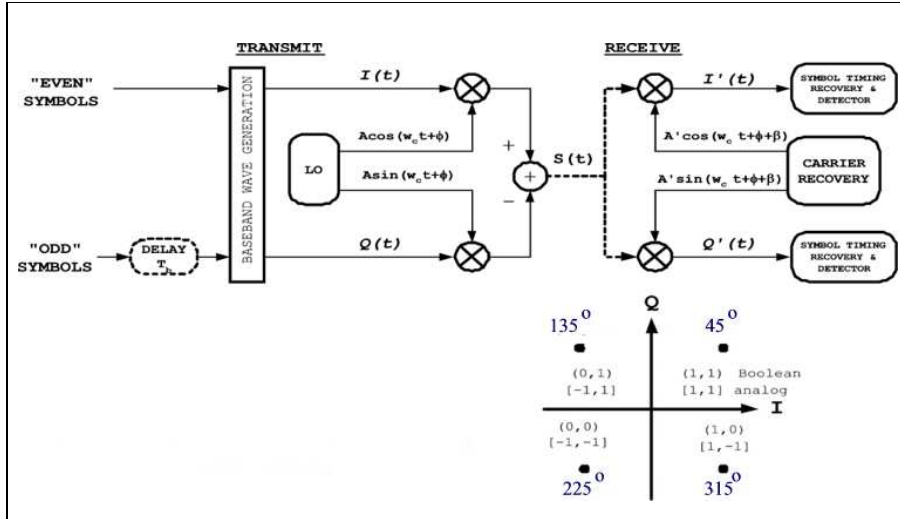

Figure M-2. OFFSET QPSK 106 Symbol to Phase Mapping Convention.

The symbol detectors have insufficient information to determine which phase offset exists. They always interpret demodulator output with the assumption that  $\beta=0$ . The resulting constellation axis rotations and their impact on demodulator output are shown at Figure M-3 and Table M-1. The 180-degree rotation is symmetric. The Axis (subcarrier) assignment is unchanged but the sense (polarity) of both axes gets reversed. The 90-degree and 270-degree rotations are asymmetric. Axis assignment is swapped and one axis polarity is reversed in each case.

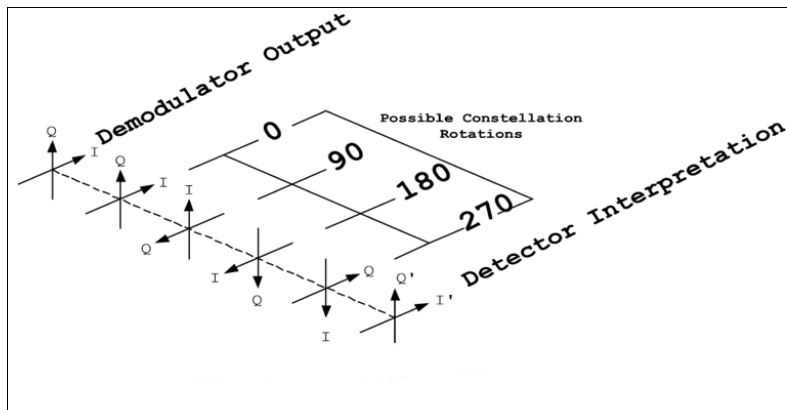

Figure M-3. Detection ambiguity.

TABLE M-1. CONSTELLATION AXIS ROTATIONS		
Rotation	+I'	+Q'
0	I	Q
$\pi/2$	-Q	I
$\pi$	-I	-Q
$3\pi/2$	Q	-I

### 3.0 A Simple Solution To The Carrier Phase Ambiguity Problem

Differential encoding has been used to work around the carrier ambiguity for many years. For phase modulations, source data is coded such that phase *differences* rather than absolute phase coordinates become the information-bearing attribute of the signal. The QPSK and OQPSK modulations use *I* and *Q* independently, with each channel transporting one symbol stream. Starting with the first binary digit, bit 0, even numbered bits form the sequence  $\{e_k\}$  and odd numbered bits form the sequence  $\{o_{k+1}\}$  where the counting index is changed from the bit index  $n$  to the symbol pair index

$$k = 2n \quad k \in \{0,2,4,6,\dots\} \quad (M-1)$$

Figure M-4 illustrates how QPSK modulators process bits in pairs (dibits), mapping and asserting time coincident symbol phase coordinates  $(I_k, Q_k)$ <sup>53</sup>. Phase state changes commence and end on *symbol* interval timing boundaries, each state taking on one of four possible values at detector decision instants. However, the case of interest is shown in Figure M-5.

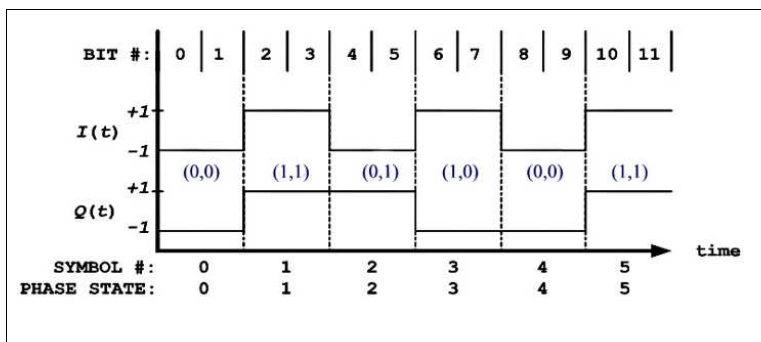

Figure M-4. QPSK State Timing

<sup>53</sup> Rectangular *I* and *Q* baseband waveforms are used only for illustration.

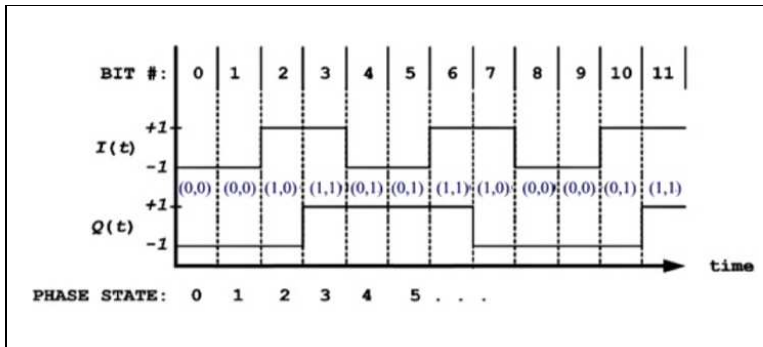

Figure M-5. OFFSET QPSK State Timing.

The Q channel half-symbol delay causes OQPSK phase trajectories to evolve on a half-symbol (bit) rate basis. For the particular cases of FQPSK and SOQPSK-TG, carrier phase either remains unchanged or changes by  $\pm\pi/4$  or  $\pm\pi/2$  radians over the pending bit interval.

The OQPSK inter-channel delay might at first seem a difficult complication because it creates additional ambiguity; in other words, the receiver must resolve relative inter-channel delay. However, as shown below, this is not a problem.

The differential encoding rule adopted in IRIG-106 for OQPSK appears in reference [M-4] and is therein attributed to Clewer in reference [M-5] and Weber in reference [M-6]. Bit by bit, the code symbol sets  $\{E_k\}$  and  $\{O_{k+1}\}$  are formed with the Boolean expressions:

$$\left. \begin{aligned} E_k &\equiv e_k \oplus \bar{O}_{k-1} && \text{(M - 2a)} \\ O_{(k+1)} &\equiv o_{k+1} \oplus E_k && \text{(M - 2b)} \end{aligned} \right\} \text{(M - 2)}$$

Two bits are coded for each value of  $k$  in a two-step process. First, the even symbol  $E_k$  is coded with current bit  $e_k$ . Then the next bit,  $o_{k+1}$  becomes current and the odd symbol  $O_{k+1}$  is computed. In each code set the exclusive-or operator is applied to the state defining variables just like BPSK differential encoding. Unlike BPSK however, the current source bit and the most recent code symbol from the other channel determine adjacent phase transitions. Also note the asymmetry of these equations introduced by the inverted code symbol in equation (M-2a). Its significance will become evident in the next section.

The code symbol sets  $\{E\}$  and  $\{O\}$  are applied to the  $I$  and  $Q$  channels of the OQPSK modulator. The initial assignment of  $\{E\}$  to either  $I$  or  $Q$  can be made arbitrarily. However, with this code definition, once the choice is made at the modulator, decoding will fail if channel assignment conventions change anywhere during the transmission or decoding processes. Thus, the assignment convention must extend to the physical modulator and demodulator. IRIG -06 assigns  $I$  to the physical  $I$  subcarrier (also known as the “real” or “cosine” subcarrier) and  $Q$  is

applied to the physical  $Q$  subcarrier (also known as the “imaginary” or “sine” subcarrier). In order to stress this assignment convention, IRIG-106 expresses equation (M-2) explicitly in terms of the  $I$  and  $Q$  channel variables:

$$\left. \begin{aligned} I_k &\equiv e_k \oplus \overline{Q}_{(k-1)} & (M - 3a) \\ Q_{(k+1)} &\equiv o_{(k+1)} \oplus I_k & (M - 3b) \end{aligned} \right\} k \in \{0, 2, 4, 6, \dots\} \quad (M - 3)$$

Decoding is straightforward. When  $\beta=0$ ,  $I'=I$ , and  $Q'=Q$ , inspection of the following truth tables reveals simple decoding instructions:

Equation (M - 3a)	Equation (M - 3b)	
$I_k \quad \overline{Q}_{(k-1)} \quad e_k$	$Q_{(k+1)} \quad I_k \quad o_{(k+1)}$	
0    0    0	0    0    0	
0    1    1	1    0    1	⇒ decoding equation :
1    0    1	0    1    1	
1    1    0	1    1    0	

$$\left. \begin{aligned} e'_k &= I'_k \oplus \overline{Q}'_{k-1} & (M - 4a) \\ o'_{k+1} &= Q'_{k+1} \oplus I'_k & (M - 4b) \end{aligned} \right\} k \in \{0, 2, 4, 6, \dots\} \quad (M - 4)$$

The equations at (M-3) may not convey an intuitive sense of the shift from absolute phase states to phase differences. Extending (M-3a) backwards in time by substituting (M-3b) into (M-3a) results in:

$$I_k = e_k \oplus (\overline{o_{k-1} \oplus I_{k-2}}) = I_{k-2} \oplus (\overline{e_k \oplus o_{k-1}}) \quad (M - 5)$$

Similarly, for the next bit interval the results are:

$$Q_{k+1} = o_{k+1} \oplus (\overline{e_k \oplus \overline{Q}_{k-1}}) = Q_{k-1} \oplus (\overline{o_{k+1} \oplus e_k}) \quad (M - 6)$$

This recursive form clearly shows that on a bit by bit basis, the current and most recent bits control phase trajectory *motion*, not absolute phase. Note that (M-5) and (M-6) do not define the sign of a phase change. Predictable decoder output requires that two additional conventions be established and maintained. Boolean logic polarity conventions used throughout the system must be consistent. IRIG-106 *assumes* positive true logic. Finally, sign conventions and channel



assignment used within the transmitter (baseband signal generator and modulator) and the receiver (demodulator) must be constrained to produce a consistent code symbol to phase mapping convention. The IRIG-106 convention is shown in Figure M-2. For example, if {b} were to consist entirely of logic one values, i.e., a run of 1s, the differential encoding process and mapping convention will produce the phase trajectory shown in Table M-2.

TABLE M-2. RESPONSE TO RUN OF 1S							
n	b(n)	k	I <sub>k</sub>	Q <sub>k-1</sub>	Q <sub>k+1</sub>	Phase (deg)	Phase Δ
0	1	0	0	0*		225*	
1	1				1	135	-π/2
2	1	1	1	1		45	-π/2
3	1				0	315	-π/2
4	1	2	0	0		225	-π/2
5	1				1	135	-π/2

\* denotes assumed initial conditions

The trajectory spins clockwise, and the phase is retarded by 90 degrees during each bit interval.<sup>54</sup> Obviously, any single (unbalanced) sign change and any change to the mapping convention will alter the trajectory.

#### 4.0 Immunity to Carrier Phase Rotation

The equations at (M-3) and (M-4) are invariant with respect to cardinal constellation rotation as shown in the following:

*Proof:*

The β=0 case is decoded correctly by definition according to equations (M-5) and (M-6). At Table M-1, when β = π there is no axis swap but the decoder is presented with

$$I'_k = \bar{I}_k$$

$$Q'_{k+1} = \bar{Q}_{k+1}$$

<sup>54</sup> FQPSK-B, FQPSK -JR and SOQPSK-TG modulations respond to a run of 1s with an S(t) that is ideally, a pure tone at frequency  $f_c - r_b/4$  Hz. This is referred as “lower sideband” mode. Similarly, a run of zeroes will produce a constant anti-clockwise trajectory spin and a tone at  $f_c + r_b/4$  Hz (“upper sideband” mode).

Decoding will progress as follows:

Step 1. Even channel; apply equation (M-4a);

$$e'_k = I'_k \oplus \bar{Q}'_{k-1} = \bar{I}_k \oplus Q_{k-1} = I_k \oplus \bar{Q}_{k-1} = e_k$$

Step 2. Odd channel; apply equation (M-4b);

$$o'_{k+1} = Q'_{k+1} \oplus I'_k = \bar{Q}_{k+1} \oplus \bar{I}_k = Q_{k+1} \oplus I_k = o_{k+1}$$

Thus, symmetric rotation is transparent to the code. When  $\beta=\pi/2$  the decoder sees

$$\begin{aligned} I'_k &= \bar{Q}_{k-1} \\ Q'_{k+1} &= I_k \end{aligned}$$

Decoding takes place in the same sequence:

Step 1. even channel, apply equation (M-4a);

$$e'_k = I'_k \oplus \bar{Q}'_{k-1} = \bar{Q}_{k-1} \oplus \bar{I}_k = I_k \oplus Q_{k-1} = o_{k-1}$$

Step 2. odd channel, apply equation (M-4b);

$$o'_{k+1} = Q'_{k+1} \oplus I'_k = I_k \oplus \bar{Q}_{k-1} = e_k$$

In this case the bit sequence is recovered correctly and the code definition coupled with consistent sign conventions automatically compensates for the asymmetric rotation by reversing the application order of (4a) and (4b). It is noted that the output indexes are shifted back in time one bit period. Asymmetric rotation causes a one-bit delay in the decoding process. Finally, the same result is seen when  $\beta=3\pi/2$ :

$$\begin{aligned} I'_k &= Q_{k-1} \\ Q'_{k+1} &= \bar{I}_k \end{aligned}$$

Step 1. Even channel; apply equation (M-4a);

$$e'_k = I'_k \oplus \bar{Q}'_{k-1} = Q_{k-1} \oplus I_k = I_k \oplus Q_{k-1} = o_{k-1}$$

Step 2. Odd channel; apply equation (M-4b);

$$o'_{k+1} = Q'_{k+1} \oplus I'_k = \bar{I}_k \oplus Q_{k-1} = I_k \oplus \bar{Q}_{k-1} = e_k$$

In all cases the decoder correctly reproduces the original bit sequence. Decoding is instantaneous for symmetric rotations but it is delayed by one bit in 2 out of 4 possible asymmetric rotation startup scenarios.

The need for consistent function assignment now becomes clear. Application of (4b) to a code symbol formed with (3a) produces the complement of the original bit. Likewise, application of (4a) to a symbol coded with (3b) inverts the result.

At this point, the QPSK inter-channel delay ambiguity mentioned in section 2 has not been resolved. The roles of  $I'$  and  $Q'$  reverse with asymmetric rotations and there is no way to determine when this occurs. However, as long as the code symbol time sequence is preserved at the decoder and the roles of  $I'$  and  $Q'$  do not get reversed in terms of the application of (6a) and (6b), inter-channel delay is transparent to the code with respect to reconstruction of the original data sequence.<sup>55</sup>

## 5.0 Initial Values

Equations at (M-3) and (M-4) do not impose any implementation constraints on initial values when encoding or decoding starts. To confirm this it is assumed that hardware power-up (or initial data presentation) may cause encoding to commence with either channel. It is further assumed that no provisions for specific initial values in encoder and decoder state memories have been made. If coding starts with  $I$  (see equation M-3a), the first code symbol will be computed:

$$\|I_0\| = e_0 \oplus \langle \bar{Q}_{-1} \rangle$$

where  $\langle . \rangle$  denotes an unknown initial value and double vertical bars denote computed values influenced by initial values. Encoding equations M-3a and M-3b will progress as follows:

$$\begin{aligned} \|Q_1\| &= o_1 \oplus \|I_0\| \\ \|I_2\| &= e_2 \oplus \|\bar{Q}_1\| \end{aligned}$$

As can be seen, the initial values do establish the absolute sense of code symbols for the duration of transmission. But, on both ends of the process, two of three terms in every equation are affected consistently by the initial value, which by symmetry has no effect on the outcome of exclusive-or operations. Obviously, identical results occur if the encoder starts with  $Q$ . Independent of starting channel and initial value then, the first and all subsequent adjacent code symbol pairs contain valid state *change* information.

---

<sup>55</sup> If for some reason the system application requires that one can determine whether a specific symbol was originally transmitted via  $I$  or  $Q$ , then this code is not appropriate.

Initial decoder values can produce errors. Again starting with  $I$ , and using equations (M-4a) and (4b), decoding will progress as follows:

$$\begin{aligned}\|e'_0\| &= I'_0 \oplus \langle \bar{Q}'_{-1} \rangle \\ o'_1 &= Q'_1 \oplus I'_0\end{aligned}$$

It is seen that on the second cycle the initial value of the decoder has been flushed out. At most, one bit will be decoded in error. Similarly, if decoding starts with  $Q$ , output will progress:

$$\begin{aligned}\|o'_1\| &= Q'_1 \oplus \langle I'_0 \rangle \\ e'_2 &= I'_2 \oplus \bar{Q}'_1\end{aligned}$$

Again, only the first decoded bit may be incorrect. The conclusion, then, is that initial values can produce at most, one decoded bit error. However, there is another source of startup errors that is seen as an initial value problem. Section 4.0 showed that odd phase rotations ( $\pi/2$  and  $3\pi/2$ ) cause a single bit delay in the decoder. Examining this further, the first symbol index value will be  $k = 0$ . If the decoder starts with equation (M-4a), the first decoded bit will be:

$$e'_0 = I'_0 \oplus \langle \bar{Q}'_{-1} \rangle = I_0 \oplus \langle Q_{-1} \rangle = \langle o_{-1} \rangle$$

If the decoder starts with equation (M-4b) the first result will be:

$$o'_1 = Q'_1 \oplus I'_0 = I_0 \oplus \langle \bar{Q}_{-1} \rangle = \|e_0\|$$

The first case produces the aforementioned delay. The decoder emits an extra bit. The second bit emitted is actually the first bit of the sequence reconstruction and is still subject to the single initial value error probability of startup processing. The latter case does not produce a delay; it only presents the possibility of a first bit decoding error.

## 6.0 Error Propagation

Differential encoding incurs a bit error penalty because received code symbols influence more than one decoded bit. First consider a single symbol detection error in *current* symbol  $E'$  which is labeled  $\varepsilon_k$ . The following sequence of decoding steps shows how the error propagates. Since the  $E$  channel was chosen as current, decoding starts with equation (M-4a). The single detection error creates two sequential decoding errors. By symmetry we can state that the same result occurs if a single error occurs in  $O'$ .

$$\begin{aligned}b'_k &= \varepsilon_k \oplus \bar{Q}_{k-1} = \bar{b}_k \Rightarrow \text{error} \\ b'_{k+1} &= Q_{k+1} \oplus \varepsilon_k = \bar{b}_{k+1} \Rightarrow \text{error} \\ b'_{k+2} &= E'_{k+2} \oplus Q'_{k+1} = b_{k+2} \Rightarrow \text{correct}\end{aligned}$$

Next is the case of two symbol detection errors occurring consecutively on  $E'$  and  $O'$ , i.e., detectors emit error symbols  $E'_{k=\varepsilon_k}$  and  $O'_{k+1=\varepsilon_{k+1}}$ . Starting again with equation (M-4a) yields:

$$\begin{aligned} b'_k &= \varepsilon_k \oplus \bar{Q}_{(k-1)} = \bar{b}_k \Rightarrow \text{error} \\ b'_{(k+1)} &= \varepsilon_{(k+1)} \oplus \varepsilon_k = O'_{(k+1)} \oplus E_k = b_{(k+1)} \Rightarrow \text{correct} \\ b'_{(k+2)} &= E'_{(k+2)} \oplus \varepsilon_{(k+1)} = b_{(k+2)} \Rightarrow \text{error} \\ b'_{(k+3)} &= O'_{(k+3)} \oplus E'_{(k+2)} = b_{(k+3)} \Rightarrow \text{correct} \end{aligned}$$

Two consecutive symbol errors produce two decoding errors but the errors are not adjacent. The conclusion from this is that symbol detection errors influence no more than two decoding cycles, i.e., the maximum error multiplication factor is 2.

## 7.0 Recursive Processing and Code Memory

Most systems reconstruct the original bit rate clock and  $\{b\}$  by merging  $\{e'\}$  and  $\{o'\}$ . For a variety of reasons, designers might be tempted to multiplex  $\{I'\}$  and  $\{Q'\}$  into a bit rate code symbol sequence  $\{B_n\}$  prior to decoding. However, the same considerations that foster desire for post-multiplex decoding are likely to be accompanied by loss of transmitted code symbol order, i.e., loss of knowledge whether a given code symbol came from  $I$  or  $Q$ . The question arises as to whether  $\{B_n\}$  alone contains enough information for unique decoding. The answer is “no”, and the proof is shown below.

Proof:

An alluring decoding function can be derived by inspection of equations (M-5) and (M-6). Equation (M-5) can be rearranged as follows:

$$I_k = e_k \oplus o_{k-1} \oplus \bar{I}_{k-2} \quad (\text{M-7})$$

Similarly, from equation (M-6) we can write

$$Q_{k+1} = o_{k+1} \oplus e_k \oplus \bar{Q}_{k-1} \quad (\text{M-8})$$

Here are two instances of a seemingly identical recursive relationship, i.e., the current code symbol is the difference between the current bit, the previous bit, and the inverse of the most recent code symbol from the current channel. We can consolidate these equations by converting to post-multiplex bit rate indexing, i.e.,

$$B_n = b_n \oplus b_{(n-1)} \oplus \bar{B}_{(n-2)} \quad (\text{M-9})$$

from which we can immediately write the decoding function

$$b'_n = b'_{(n-1)} \oplus B'_n \oplus \bar{B}'_{(n-2)} \quad (\text{M-10})$$

On the surface it seems that equation (M-10) will work.<sup>56</sup> However, these relations involve two differences, rather than one, and therefore introduce superfluous initial condition dependence. For brevity, only the pitfalls of (M-10) are examined herein, assuming that a non-recursive encoder is used. From startup, decoding will progress as follows:

$$\begin{aligned} \|b'_0\| &= \langle b'_{-1} \rangle \oplus B'_0 \oplus \langle \overline{B}'_{-2} \rangle \\ \|b'_1\| &= \|b'_0\| \oplus B'_1 \oplus \langle \overline{B}'_{-1} \rangle \\ \|b'_2\| &= \|b'_1\| \oplus B'_2 \oplus \overline{B}'_0 \\ \|b'_3\| &= \|b'_2\| \oplus B'_3 \oplus \overline{B}'_1 \\ &\vdots \end{aligned}$$

As seen, absolute polarity of the first and all subsequent decoded bits is determined by three (3) initial values. Absent appropriate a priori side information for selecting initial values, the post-multiplex decoder offers a 50-50 chance of decoding with correct polarity. The code sequence defined by equations at (M-3) has a two-symbol memory. Additional symbols do not provide new information regarding the trajectory history. Another way to view this problem is to note that this recursive decoder does not guarantee preservation of symbol order, which is a prerequisite to reliable decoding.

## 8.0 Frequency Impulse Sequence Mapping for SOQPSK

The SOQPSKs first described by Hill and Geohegan in references [M-7] and [M-8] are defined as special cases of continuous phase modulation (CPM). Since 1998, at least two manufacturers have exploited the fact that modern digital waveform synthesis techniques enable direct implementation of the CPM equations with virtually ideal frequency modulators and filter impulse responses. A generic model of these implementations is at Figure M-6. The I and Q channels, per se, do not exist in this transmitter. At the beginning of each bit interval, impulses from the bit to impulse alphabet mapper direct the impulse filter/frequency modulator to advance the carrier phase by 90°, retard it by or 90°, or leave the phase unchanged. This is accomplished with a ternary alphabet of frequency *impulses* having normalized amplitudes of {-1,0,1}.<sup>57</sup> Obviously, this structure cannot be mapped directly into the constellation convention of a quadriphase implementation because there is no way to control absolute phase. The equations at (M-3) can be applied to this non-quadrature architecture via pre-coding. A general treatment SOQPSK pre-coding is contained in reference [M-9]. It is easily shown that the pre-coding truth table given in Table M-3 applied to the model in Figure M-7 will yield a phase trajectory history identical to one generated by the quadriphase counterpart of Figure M-2 using the equations at (M-3). However, one more constraint is necessary to establish compatibility with the IRIG-106 quadriphase convention. Table M-3 assumes the stipulation that positive sign impulse values will cause the modulator to increase carrier frequency.

<sup>56</sup> The interested reader is left to confirm that equation (10) is indeed rotation invariant.

<sup>57</sup> The so-called ternary alphabet is actually 2 binary alphabets {-1,0} and {0,1}, the appropriate one chosen on a bit-by-bit basis according to certain state transition rules.

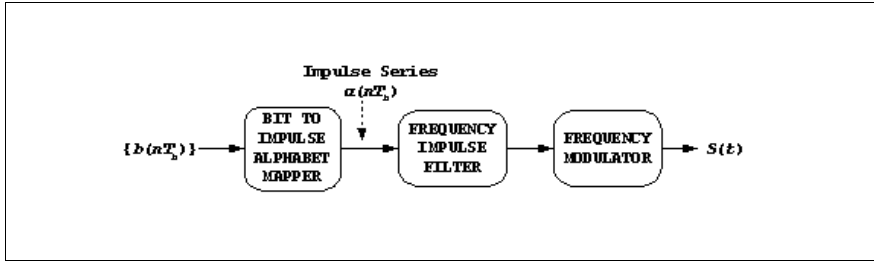

Figure M-6. Basic SOQPSK Transmitter.

TABLE M-3. SOQPSK PRE-CODING TABLE FOR IRIG-106 COMPATIBILITY									
MAP $\alpha_k$ FROM $I_k$					MAP $\alpha_{k+1}$ FROM $Q_{k+1}$				
$I_k$	$Q_{k-1}$	$I_{k-2}$	$\Delta\Phi$	$\alpha_k$	$Q_{k+1}$	$I_k$	$Q_{k-1}$	$\Delta\Phi$	$\alpha_{k+1}$
-1	X*	-1	0	0	-1	X*	-1	0	0
+1	X*	+1	0	0	+1	X*	+1	0	0
-1	-1	+1	$-\pi/2$	-1	-1	-1	+1	$+\pi/2$	+1
-1	+1	+1	$+\pi/2$	+1	-1	+1	+1	$-\pi/2$	-1
+1	-1	-1	$+\pi/2$	+1	+1	-1	-1	$-\pi/2$	-1
+1	+1	-1	$-\pi/2$	-1	+1	+1	-1	$+\pi/2$	+1

\* Note: Does not matter if “X” is a +1 or a -1

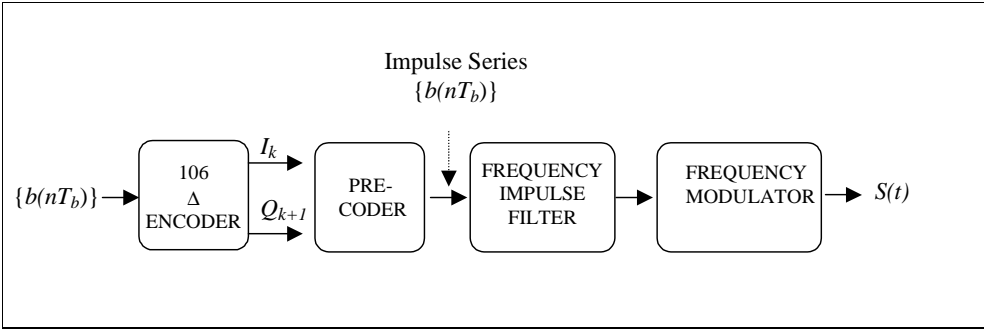

Figure M-7. OQPSK Transmitter (with precoder).

## 9.0 Summary<sup>58</sup>

This investigation confirmed that the differential encoder defined in the equations at (M-3) is entirely satisfactory for SOQPSK, FQPSK-JR and FQPSK-B systems where conventional coherent demodulation and single symbol detection is used. In addition, a method of extending this code to SOQPSK is presented without proof.

Specifically, the following has been shown:

- a. When accompanied by consistent sign conventions, a consistent symbol to phase mapping rule, and preservation of symbol order, the OQPSK differential code defined in (M-3) and the decoding rule defined in (M-4) is rotation invariant and unambiguously reconstructs the original data bit sequence.
- b. Decoding is instantaneous.
- c. Equations (M-3) and (M-4) do not require attention to initial values.
- d. At most, two consecutive output bits will be in error after carrier and symbol synchronization is acquired.
- e. The recursive relations in (M-9) and (M-10) are ambiguous and therefore unreliable.
- f. The code exhibits a detection error multiplication factor of at most two.

---

<sup>58</sup> There is no doubt in the author's mind that well trodden ground has been traveled in this investigation. These characteristics were probably validated in reference [5] and by RF Networks Inc. before it incorporated the encoder in its model 5450F FQPSK demodulator product. Unfortunately, none of this work is in the public domain.



## ANNEX 1 TO APPENDIX M

# SYSTEM LEVEL SOFTWARE REFERENCE IMPLEMENTATION OF DIFFERENTIAL ENCODER DEFINED IN IRIG STANDARD 106 FOR FQPSK AND SOQPSK MODULATIONS

### 1.0 Introduction

The Matlab®™ program listings below provide a Matlab function “Desysdemo” and an execution control script “runDEdemo”. In the context of differential encoding, the function provides a complete system simulation including a differential encoder, an ideal vector modulator, channel phase rotation, demodulation, the functional equivalent of an ideal single symbol sample and hold detector, and a decoder. The user can create sample data vectors or use the example data provided. In addition, by manipulating the initial value vectors, all possible initial value and demodulator phase rotation combinations of the quadriphase implementation model can be explored.

By setting the variable “style” to zero, the function will also emulate the pre-coded frequency modulator architecture required for SOQPSKs. However, the initial value of transmitter carrier phase is hard coded at 45 degrees. This was done to avoid proliferation of initial value options and is thought to be an insignificant omission because it does not affect generality of the phase rotation options.

It is assumed that the user is familiar with Matlab workspace operation. The program relies only on basic Matlab license libraries. There are no special toolboxes or blocksets are required.

### 2.0 Matlab Workspace Operation

The user should place the script (shown below in paragraph 3.0 of this Annex) in the directory of choice and make that directory current in the workspace. In order to execute the “canned” example, the user needs to create the variable “example” in the workspace and set its value to 1.

Executing the script “runDEdemo” should produce the following output:

```

results =

Model: Quadriphase Vector Modulator
Demodulator Phase Rotation = 0 degrees

Initial States:  Encoder  Encoder  Decoder  Decoder
                  Memory   Channel  Memory   Channel
-----
                  (0,0)    0        (0,0)    0

Input  TX      RX      Output  Decoding
Bit    Phase  Phase  Bit     Error
-----
1      225    225    1       0
1      135    135    1       0
1      45     45     1       0
0      45     45     0       0
0      135    135    0       0
1      135    135    1       0
0      135    135    0       0
1      135    135    1       0
1      45     45     1       0
1      315    315    1       0
0      315    315    0       0
0      45     45     0       0
1      45     45     1       0
0      45     45     0       0

```

The first column of the results shown above is a replica of the input data vector. The second column shows the initial value dependent evolution of transmitted phase. The third column shows the effect of any non-zero phase rotation chosen. The fourth column shows the decoded output bit stream and the fifth column flags decoding errors with values of 1. Certain combinations of phase rotation and initial values will produce values of 9 in the fourth and fifth columns; results of this nature are associated with cases that delay the output decoding process by one bit.

Variable definitions and implied instructions for manipulating the runtime options can be obtained by using the normal Matlab help command for these specific programs.

### 3.0 Script For Modules

Electronic copies of these programs have been provided to the DoD Range Commanders Council, Telemetry Group. The script for the modules discussed above is shown on the following pages.

```

% Control Script 'runDEdemo', for running system demonstration
% of differential encoder and phase mapping convention
% defined in RCC standard IRIG-106 for FQPSK-B modulation.
% This version extends demonstration options to the pre-coder
% required for implementing SOQPSK with frequency modulators.
%
% Each example run requires input variables in the Matlab workspace:
%
% "example" - a flag to run with user supplied data vector or run
% the example data set that consists of two repetitions of a
% a 7-bit pseudo random sequence(0=user, 1=example)
% "data" - optional user supplied binary bit sequence (arbitrary length)
% "rotation_choice" - pointer to demodulator phase rotation options:
% 1=0, 2=pi/2, 3= pi, 4=3*pi/2
% "initTX" - vector of binary encoder startup values:
% initTX(1)= 1st of two encoder code symbol memory values(binary, arbitrary)
% initTX(2)= 2nd encoder code symbol memory value(binary, arbitrary)
% initTX(3)= starting channel for encoder(binary, 0=I, 1=Q)
% "initRX" - vector of binary decoding startup values
% initRX(1)= 1st of two decoder state memory values(binary, arbitrary)
% initRX(2)= 2nd decoder state memory value(binary, arbitrary)
% initRX(3)= starting channel for decoder(binary, 0=I, 1=Q)
% "style" - 1=quadrature transmitter architecture (FQPSK)
% 0=frequency modulator transmitter architecture (SOQPSK)
% The example values are:
% data=[1 1 1 0 0 1 0 1 1 1 0 0 1 0]
% rotation_choice=1
% initTX=[0 0 0]
% initRX=[0 0 0]
% style=1

% R.P.Jefferis, TYBRIN Corp., JULY, 2002
% SOQPSK model added 14JUL03
% This version has been tested with Matlab versions:5.2,6.1

% *** Sample Input Setup ***
if example
    data=[1 1 1 0 0 1 0 1 1 1 0 0 1 0];
    rotation_choice=1;
    initTX=[0 0 0];
    initRX=[0 0 0];
    style=1;
end

% *** Run the Reference Implementation ***

```

```

[test,delay]=DEsysdemo(data,rotation_choice,initTX,initRX,style);

% *** Prepare Screen Output ***

ROTATION=[0 90 180 270];
if style
    results=sprintf('Model: Quadriphase Vector Modulator\n');
else
    results=sprintf('Model: Frequency modulator (SOQPSK) model\n');
end
results=[results sprintf('Demodulator Phase Rotation = %3.0f
degrees\n',ROTATION(rotation_choice))];
results=[results sprintf('Initial States: Encoder Encoder Decoder Decoder\n');
results=[results sprintf('          Memory Channel Memory Channel\n');
results=[results sprintf('-----\n');
results=[results sprintf('          (%d,%d)  %d  (%d,%d)  %d\n',...
    initTX(1:2),initTX(3),initRX(1:2),initRX(3))];
results=[results sprintf(' Input TX   RX   Output Decoding\n');
results=[results sprintf(' Bit Phase Phase Bit   Error\n');
results=[results sprintf('-----\n');
for n=1:length(data)
    results=[results sprintf(' %d  %3.0f  %3.0f  %d  %d\n',...
        test(n,:))];
end
results

% _____END OF CONTROL SCRIPT_____

function [result,delay]= DEsysdemo(inbits,rotation_choice,initTX,initRX,style)
% Reference simulation for Range Commanders Council standard IRIG 106-2000
%   FQPSK-B differential encoding and phase mapping convention.
%
% Input arguments: see "help" for "runDEdemo" script
% Output arguments:
%   "result" - Mx5 matrix,M=number of input bits,columns contain:
%   (:,1)input bit,(,2)TX phase,(,3)RX phase,(,4)output bit,(,5)status
%   "delay"- overall encode/decode process delay in bits

% "TX" prefixes refer to transmitter/encoder variables, "RX" prefixes
% refer to receiver/decoder variables
% Robert P. Jefferis, TYBRIN Corp., July,2002.
% SOQPSK model added 14JUL03
% This version has been tested with Matlab versions: 5.2,6.1
numbits=length(inbits)

% *****

```

```

% * Transmitter *
% *****

% *** differential encoder (also SOQPSK pre-coder)****

% encoder memory initial values:
% [(last I ch. code symbol) (last Q ch. code symbol)]
TXlastSYM=initTX(1:2);
% point encoder to either I or Q starting channel(0=I)
TXpoint=initTX(3);
for n=1:numbits
    switch TXpoint
    case 0
        % TXlastSYM
        % compute "current" I channel code symbol
        TXnewISYM=xor(inbits(n),~TXlastSYM(2));
        TXcodeSYM(n,:)=[TXnewISYM TXlastSYM(2)]; % new phase coordinates(I,Q)
        TXlastSYM(1)=TXnewISYM; % update encoder memory state
        TXpoint = ~TXpoint; % point to Q channel eq. for next bit
    case 1
        % compute "current" Q channel code symbol
        TXnewQSYM=xor(inbits(n),TXlastSYM(1));
        TXcodeSYM(n,:)=[TXlastSYM(1) TXnewQSYM]; % new phase coordinates(I,Q)
        TXlastSYM(2)=TXnewQSYM;% update encoder memory state
        TXpoint= ~TXpoint; % point to I channel eq. for next bit
    otherwise
        disp('Invalid Specification of Encoder starting channel');
    end
end

% *** modulate ***

switch style
case 1 % ** Quadriphase vector modulator **

% RCC IRIG 106 FQPSK-B phase mapping convention: (I,Q)
for n=1:numbits
    index=floor(2*TXcodeSYM(n,1)+TXcodeSYM(n,2));
    switch index
    case 3 % [1 1]
        TXphase(n)=45; % TX phase angle, degrees
    case 1 % [0 1]
        TXphase(n)=135;
    case 0 % [0 0]
        TXphase(n)=225;
    case 2 % [1 0]

```

```

    TXphase(n)=315;
    otherwise, disp('map error')
end
end
case 0 % ** Frequency modulator w/pre-coder **

% * pre-coder *
% map code symbol sequence to frequency impulse series, alpha(n)
alpha=zeros(1,numbits);
TXpoint=initTX(3); % in this mode, points to start index
for n=3:numbits
    if TXpoint % Q(k+1) map
        if TXcodeSYM(n,2)==TXcodeSYM(n-2,2)
            elseif xor(TXcodeSYM(n,2),TXcodeSYM(n-1,1))
                alpha(n)=-1;
            else
                alpha(n)=1;
            end
        else % I(k) map
            if TXcodeSYM(n,1)==TXcodeSYM(n-2,1)
                elseif xor(TXcodeSYM(n,1),TXcodeSYM(n-1,2))
                    alpha(n)=1;
                else
                    alpha(n)=-1;
                end
            end
        TXpoint=~TXpoint; % switch to complement function for next bit
    end

% convert alpha to phase trajectory
lastTXphase=45; % initial phase of S(t)
for n=1:numbits
    TXphase(n)=mod(lastTXphase+alpha(n)*90,360);
    lastTXphase=TXphase(n);
end
otherwise
end

% *****
% * Receiver *
% *****

% *** Demodulator Phase Rotation ***
ROTATE=[0 pi/2 pi 3*pi/2];
rotate=ROTATE(rotation_choice);
for n=1:numbits

```

```

switch rotate
case 0
    RXphase(n)=TXphase(n);
case pi/2
    RXphase(n)=mod(TXphase(n)+90,360);
case pi
    RXphase(n)=mod(TXphase(n)+180,360);
case 3*pi/2
    RXphase(n)=mod(TXphase(n)+270,360);
otherwise
end
end

% *** detector ***
for n=1:numbits
    switch RXphase(n)
    case 45
        RXcodeSYM(n,:)=[1 1];
    case 135
        RXcodeSYM(n,:)=[0 1];
    case 225
        RXcodeSYM(n,:)=[0 0];
    case 315
        RXcodeSYM(n,:)=[1 0];
    otherwise
    end
end

% *** decode and reconstruct data bit sequence ***

% decoder memory initial values:
% [(last decoded I channel bit) (last decoded Q channel bit)]
RXlastSYM=initRX(1:2);
% point decoder channel to either I or Q starting channel (0=I)
RXpoint=initRX(3);
for n=1:numbits
    switch RXpoint
    case 0
        % compute "current" decoded I channel bit
        RXbits(n)=xor(RXcodeSYM(n,1),~RXlastSYM(2));
        RXlastSYM=RXcodeSYM(n,:); % update decoder state
        RXpoint = ~RXpoint; % point to Q channel eq. for next bit
    case 1
        % compute "current" decoded Q channel bit
        RXbits(n)=xor(RXcodeSYM(n,2),RXlastSYM(1));
        RXlastSYM=RXcodeSYM(n,:); % update decoder state
    end
end

```

```

    RXpoint= ~RXpoint; % point to I channel eq. for next bit

    otherwise
    end
end

% _____ END OF TX and RX Processing _____

% *****
% * Assemble Output *
% *****

% identify delay incurred in overall process
offset=xcorr(inbits,RXbits);
offset(1:numbits-1)=[];
[offset,delay]=max(offset(1:min(length(offset),10)));
delay=delay-1;

% adjust RX output bit vector to compensate for delay,
% inserting values of 9 at beginning of vector to represent
% artifact bits associated with asymmetric rotation cases
checkbits=inbits;
if delay
    newfront=ones(1,delay)*9;
    checkbits=[newfront inbits];
    checkbits(end-delay+1:end)=[];
    RXbits(1:delay)=9;
end
% identify decoding errors in reconstructed bit stream
xmsn_error=checkbits~=RXbits;
xmsn_error(1:delay)=9;
% assemble output matrix
result(:,1)=inbits';
result(:,2)=TXphase';
result(:,3)=RXphase';
result(:,4)=RXbits';
result(:,5)=xmsn_error';

% _____ END OF FUNCTION DEsysdemo _____

```



## References

- [1] Telemetry Standards, IRIG STANDARD 106, Secretariat, Range Commanders Council, White Sands Missile Range, New Mexico.
- [2] Proakis, J.G., *Digital Communications*, 5<sup>th</sup> Edition, McGraw-Hill Inc., New York, 1989.
- [3] Cacciamani, E.R and Wolejsza Jr., C.J, "Phase-Ambiguity Resolution in a Four-Phase PSK Communications System", IEEE Transactions on Communications, Vol. COM-19, No.6, December 1971.
- [4] Feher, K., *Digital Communications: Satellite/Earth Station Engineering*, Prentice-Hall Inc., New Jersey, 1983, pp. 168-170.
- [5] Cited from bibliography of reference 4 for completeness only. Not available: Clewer, R., "Report on the Status of Development of the High Speed Digital Satellite modem", RML-009-79-24, Spar Aerospace Limited, St. Anne de Bellevue, P.Q., Canada, November 1979.
- [6] Weber, W.J. III, "Differential Encoding for Multiple Amplitude and Phase Shift Keying Systems", IEEE Transactions on Communications, Vol. COM-26, No. 3, March 1978.
- [7] Hill T., "An Enhanced, Constant Envelope, Interoperable Shaped Offset QPSK(SOQPSK) Waveform for Improved Spectral Efficiency", Proceedings of the International Telemetry Conference, San Diego, California, October 2000.
- [8] Geoghegan, M., "Implementation and Performance Results for Trellis Detection of SOQPSK", Proceedings of the International Telemetry Conference, Las Vegas, Nevada, October 2001.
- [9] Simon, M.K., "Multiple-Bit Differential Detection of Offset Quadrature Modulations", IPN Progress Report 42-151, November 15, 2002, Jet Propulsion Laboratory, Pasadena, California.

This page intentionally left blank.

## INDEX

- 1553 Bus Data Attributes 9-3, 9-4, 9-56, 9-57, 9-58, 9-64
- 25 dbm bandwidth..... A-10
- 3-bit shift register..... F-1, F-3
- 5/6 modulation code ..... 6-1
- 8 to 5 conversion..... 6-54
- ADARIO..... 6-22, 6-32
- Adario data block number ..... g-4
- Aggregate format ..... 6-37
- Alignment, direct electronics..... 6-29
- Alignment, FM electronics ..... 6-29
- Allocation (of a frequency band)..... 2-1, A-1
- Alternating tag and data..... 4-7
- Analog A/D overrange..... G-7
- Analog Channels..... 6-58, 6-60
- Analog over range ..... G-16
- Analog stereo..... G-16
- Analog wide band..... G-16
- Analog-to-digital conversion ..... F-6
- Annotation text ..... G-13
- ARINC-429 data packets ..... 10-48
- ARMOR ..... 6-56, 6-59, 6-60, 6-61, L-1
- Assignment of a radio frequency..... A-1
- Async framing error..... G-13
- Asynchronous data merge..... 4-10
- Asynchronous embedded format ..... 4-7
- Attenuation ..... G-8
- Attributes
  - Airborne Hardware ..... 9-4, 9-79
  - Data Conversion 9-4, 9-26, 9-44, 9-56, 9-68, 9-69, 9-70
  - PAM ..... 9-4
- Authorization ..... 2-1, A-1, A-3, A-4
- Authorized bandwidth ..... A-8
- Azimuth ..... 6-43
- B format..... 6-40
- Back coating ..... 7-1
- Band-limited audio ..... 5-1
- Bandwidth A-2, A-8, A-9, A-10, A-11, A-12, A-14, A-15, A-16, A-17
- Bandwidth estimation and measurement ..... A-9
- Bandwidths:Occupied Bandwidth ..... 2-1
- Base ..... 7-1, 7-6
- Basic dimension..... 6-1
- Below peak ..... A-12
- Below unmodulated carrier..... A-11
- $B_i\phi-L$  ..... 4-2, 4-3, D-8, D-9
- Bias level ..... 7-1, 7-8, 7-11
- Bias recording ..... 6-2
- Bias signal, high frequency..... 6-1
- Bi-directional ..... 7-2
- Binary bit representation ..... 4-2
- Binder ..... 7-2
- Bi-phase ..... 6-1
- Bit error..... 6-2
- Bit error rate..... 6-2
- Bit jitter ..... 4-2
- Bit numbering ..... 4-4
- Bit packing density, linear ..... 6-2
- Bit rate ..... 2-13, 4-2
- Bit Rate ..... 5-2, 5-3
- Bit slip..... 6-2
- Bit count ... G-11, G-12, G-13, G-14, G-15, G-16, G-17
- Bit-oriented ..... 4-1, 4-2
- Bit-oriented characteristics ..... 4-1
- Block length..... G-11
- Block marker divisor ..... G-5
- Block rate clock ..... G-12
- Block Status Word, 1553 ..... 10-34
- Block sync ..... G-11, G-12
- Block\_count..... G-13
- Blocking..... 7-2
- Buffer overflow tag..... 8-3
- Bus data military standard ..... 4-7
- Bus error ..... 8-1
- Bus identification tag ..... 8-3
- Bus loading ..... 8-1
- Bus monitor ..... 8-1
- Carrier Phase Ambiguity Problem ..... xi, M-4
- Carrier recovery techniques ..... M-1
- Carrier suppression ..... 2-9
- Carson's rule ..... A-12
- Center frequency tolerance ..... 2-4
- Center tracks ..... 7-2, 7-11
- Certification ..... A-2, 2-4
- Channel characteristics ..... 3-1, 3-5
- Channel clock source ..... G-7
- Channel Coding ..... 6-59
- Channel ID number G-11, G-12, G-13, G-14, G-15, G-16
- Channel parameter field..... G-8
- Channel sample rate indicator..... G-7
- Channel specific data
  - PCM ..... 10-23
  - Time ..... 10-30
- Channel Specific Data
  - 1553 ..... 10-32, 10-49, 10-51, 10-52
  - Analog ..... 10-39
  - Discrete ..... 10-45, 10-48
- Channel type .. G-9, G-11, G-12, G-13, G-14, G-15, G-16, 2-4
- Class distinctions ..... 4-1
- Clock, digital serial ..... G-13

Code frame .....	6-2
Code word digital sum .....	6-2
Coefficients for minimum frequency separation .....	A-5
Coherent demodulation .....	M-2, M-14
Commutation pattern .....	K-1
Companding Speed .....	F-8
Comparator .....	F-3
Compression ratio .....	F-6
Continuous variable slope delta .....	5-1
Control and Status Lines .....	10-63
Control Script 'rundedemo' .....	M-17
Conversion speed .....	F-6
CPM .....	xii, xiv, 2-5, 2-9, 2-12, 2-13, 2-16, 2-18 A-2, A-5, A-6, A-7, A-9, A-10, A-15 A-16, A-18, A-22, A-23, A-24, M-12
Crossplay .....	6-2, 7-13
Crosstalk .....	6-2
CVSD bit rate determination .....	5-3
CVSD converter .....	5-1, F-1, F-6
CVSD decoder .....	F-2, F-4
CVSD reference level .....	F-5
Data azimuth (dynamic) .....	6-2
Data bits .....	4-10
Data blocks .....	6-48
Data bus .....	8-1
Data conversion groups .....	J-12
Data entry system .....	H-1
Data Format	
1553 .....	10-33
Discrete .....	10-46
IRIG Time .....	10-32
PCM .....	10-25
Data randomization .....	2-13
Data scatter .....	6-2
Data signaling rates .....	F-5
Data spacing .....	6-2, 6-16
Data storage .....	6-42
Data type .....	G-7
Data zone .....	6-46
Decoding technique .....	5-1
Defined parameters .....	6-36
Delta modulation .....	F-1
Demultiplex .....	6-35
Demultiplexer/demodulator .....	9-26
Demux FILL requirement .....	6-37
Destination data base .....	H-1, H-3
Deviation direction .....	6-24
Differential code .....	M-1, M-14
DIFFERENTIAL ENCODER .....	M-1, M-15
Differential encoding .....	2-5
Differential encoding .....	2-5, M-4, M-10
Digital cassette .....	6-40
Digital cassette helical scan .....	6-29
Digital Data Attributes .....	9-3, 9-31
Digital serial .....	G-13, G-14
Digital sum variation .....	6-2
Digital-to-analog conversion .....	F-6
Digitized audio .....	5-1
Dimensional specifications .....	7-5
Direct electronics .....	6-29
Direct electronics alignment .....	D-21
Direct record parameters .....	6-18
Direct recording .....	6-2, 6-18, 6-25
Discriminator channel selection filters .....	B-4
Double-density longitudinal recording .....	D-1
Double-density recording .....	6-2
Dropout .....	6-3, 7-2, 7-5
Dropouts .....	7-9, 7-11
Dual redundant data bus .....	8-1
Durability .....	7-10, 7-11
E format .....	6-40
ECC .....	6-46, 6-48, 6-50, 6-52, 6-54, 6-55
ECC code word .....	6-3
Edge margin .....	6-3
Edge margin minimum .....	6-3
Edge tracks .....	7-2, 7-11
Enable left subchannel .....	G-17
Enable right subchannel .....	G-17
Encoder output bit rate .....	5-2
Encoding technique .....	5-1
Environmental conditions .....	7-7
Erase .....	7-2, 7-11
Error correcting code .....	6-3
Error correction .....	6-48
E-Value .....	7-2
Event State, Discrete .....	10-46
Examples of frequency separation .....	A-7
Exchange of data .....	6-50, 6-52
Export program .....	H-1
Fibre channel .....	10-6
Fifty percent duty cycle .....	K-1, K-4
Filemark track .....	6-44
Fill .....	G-9, G-10, G-11, G-12, G-17
Fill words .....	G-10
Filter bandwidth .....	G-8
Filter range .....	G-8
First data sample .....	G-14, G-15, G-16, G-17
Fixed formats .....	4-2
Fixed frequency .....	D-19
Flammable materials .....	7-5
Flutter .....	6-3
Flutter compensation .....	3-5, 3-7, 6-19
Flux transition .....	6-3
Flux transition density .....	6-3
FM electronics .....	6-29
FM electronics alignment .....	D-22
FM record parameters .....	6-24
FM record systems .....	6-22
FM recording .....	6-3
FM reproduce systems .....	6-24
FM subcarrier .....	3-1, 3-5
FM subcarrier performance .....	B-1, B-2

FM system component considerations.....	B-3
FM transmitters .....	A-15
Format G-4, G-6, G-10, G-11, G-13, G-14, G-15, G-16	
Format change .....	4-6, 4-7
Format code .....	G-6
Format structure.....	6-35
Format structure change .....	4-7
Format types .....	6-40
Format Validation.....	6-61
Format zone.....	6-46
FQPSK-B.....	xiv, xvii, 2-5, 2-9, 2-11, 2-13, 2-16, 9-12
... A-2, A-5, A-6, A-7, A-9, A-10, A-16, A-18, A-19	
... A-20, A-21, M-1, M-7, M-14, M-17, M-18, M-19	
FQPSK-JR .....	xii, xiv, 2-5, 2-6, 2-7, 2-9, 2-13, 2-16
..... A-2 A-5, A-9, A-10, A-16, A-18	
..... A-19, A-20, A-21, M-1, M-14	
Fragmented words .....	4-4
Frame and pulse rate .....	K-3
Frame and pulse structure.....	K-1
Frame format identification .....	4-7
Frame Header, PCM .....	10-28, 10-46
Frame structure.....	4-4, 6-57
Frame synchronization interval .....	K-1
Frequency division multiplexing .....	3-1
Frequency Impulse Sequence Mapping .....	xi, M-12
Frequency Management Group .....	xxii, A-1
Frequency Management Group (FMG) .....	A-1
Frequency modulation .....	K-4
Frequency tolerance.....	2-4, 2-16
Frequency usage guidance.....	A-4
Gap azimuth.....	6-3, 6-4
Gap azimuth alignment.....	6-17
Gap length .....	6-17
Gap length (physical).....	6-3
Gap parameters .....	6-17
Gap scatter .....	6-16, D-15
Gap scatter (record head).....	6-3
Gap scatter (reproduce head).....	6-4
General Data Packet Format	
1553 .....	10-33
Analog .....	10-38
Discrete .....	10-44
IRIG Time Data .....	10-30
PCM .....	10-15, 10-22
General form.....	G-11, G-18
General Information .....	9-3, 9-7
General information group .....	9-7, J-3
Generic Packet Format .....	10-15
Geographical separation .....	A-7
Group Relationships .....	9-5
Guard band .....	6-40, 6-44
Guardband .....	6-4
Head (record or reproduce).....	6-4
Head designation .....	6-4
Head identification .....	6-16
Head location.....	6-16
Head placement .....	6-16
Head placement, interlaced.....	6-16
Head polarity .....	6-17, D-15
Head reference plane .....	6-4
Head segment.....	6-16, 6-17
Head segment gap azimuth .....	6-4
Head segment location.....	6-16
Head segment numbering .....	6-4
Head segment, record or reproduce .....	6-4
Head spacing.....	6-4
Head tilt .....	6-4, 6-17
Heads, in-line.....	6-4
Heads, interlaced.....	6-5
Helical scan.....	6-40, 6-56
Helical Scan .....	7-13
Helical track.....	6-5, 6-42, 6-47
Helical tracks .....	6-43
High density digital.....	7-9
High order time.....	8-5, 8-6
High resolution .....	7-1, 7-9
High-density digital magnetic tape .....	7-2
High-density digital recording .....	6-5
High-density PCM recording.....	6-25, D-2
High-energy magnetic tape.....	7-2
High-resolution magnetic tape.....	7-2
Idle channel noise .....	F-9
IF filter.....	xiv, 2-17, A-5, A-15
Immunity to Carrier Phase Rotation .....	xi, M-7
Implied parameters and limits.....	6-35
Import program.....	H-1
In-flight calibration.....	9-72, K-1
Input and output filters.....	F-5
Input and output impedances .....	F-5
Input band pass filter .....	F-3
Input/output .....	6-32
Insertion loss.....	F-8
Insertion process .....	4-10
Interchange medium .....	H-1, H-3
Interference .....	2-14, 2-15
Interference limits.....	2-14
Interleave buffer.....	6-50
Interleaving.....	6-5
Intermediate frequency bandwidths.....	2-17
Internal sampling .....	G-14, G-16, G-17
Internal/external clock .....	G-12, G-14, G-15
J/F 12 number .....	A-2
L Band .....	2-3
Last data sample .....	G-14, G-15, G-16, G-17
Layer-to-layer signal transfer.....	7-2, 7-11
Left subchannel over range.....	G-17
Length, 1553 .....	10-36
Load point.....	6-46
Logical beginning of tape .....	6-46
Logical end of tape .....	6-46
Logical format .....	9-2
Long term accuracy and stability.....	K-3

Longitudinal recording .....	6-6
Longitudinal tracks .....	6-44
Low order time .....	8-5, 8-6
Magnetic oxide coating .....	7-3
Magnetic tape .....	6-18, 6-28, 7-1, 7-2, 7-13
Magnetic tape characteristics.....	6-18
Major frame .....	4-6
Manual of regulations .....	A-1, A-4, A-9
Manufacturer's centerline tape.....	7-3, 7-4
Manufacturer's secondary centerline tape.....	7-4
Manufacturer's secondary centerline Tape .....	7-3
Master clock .....	G-4, G-5
Matlab Workspace Operation .....	xi, M-15
Matlab®™ program .....	M-15
Maximum burst length.....	8-1
Maximum pulse rate .....	K-3
Maximum submultiple frame length.....	K-4
Measurement list change .....	4-7
Mechanical parameters .....	6-16
Microsecond time .....	8-5, 8-6
Minimum Frequency Separation .....	xviii, A-4
Minor frame.....	4-4, 4-6
Minor frame composition .....	4-4
Minor frame length .....	4-4
Minor frame numbering.....	4-6
Minor frame synchronization .....	4-4
Miscellaneous information inclusion.....	6-54
Modulated transmitter bandwidth.....	2-15
Modulation code .....	6-56
Modulation methods .....	A-2
Modulation noise .....	7-3, 7-11
Modulation polarity .....	2-14
Multicarrier operation.....	A-7
Multiple and submultiple sampling rates.....	K-3
Multiplex/demultiplex .....	6-32, 6-56
Multiplex/Modulation Attributes.....	9-3, 9-26
Multiplex/modulation groups .....	J-4
Multiplexer format.....	6-56
Necessary bandwidth.....	A-9
No samples in current block .....	G-7
Non return to zero-level.....	6-5
Nonoperating environment .....	7-7
NRZ-L .....	2-4, 2-5, 4-2, 4-3, 9-34, A-2, A-5, A-24
NRZ-L .....	C-1, D-8, D-10, J-7, J-8, L-5, L-6
NRZ PCM/FM.....	A-5, A-10, A-11, A-13, A-15, A-17
Occupied bandwidth.....	A-8
One hundred percent duty cycle .....	K-3, K-4
Operating environment .....	7-7
Operational flexibility.....	2-15, 2-17
Organization .....	9-4
Other bandwidth measurement methods.....	A-11
Other notations .....	A-2
Output low-pass filter .....	F-2, F-4
Output power .....	2-4
Overload algorithm.....	F-1, F-2, F-3, F-4, F-6
Overrun.....	G-12, G-13, G-14, G-15
Overrun parity.....	G-13
Pacer Divisor Calculation .....	6-59
Packaging.....	7-5
Packed Data Mode .....	
Analog .....	10-44
PCM .....	10-27
Packet Format .....	
1553 .....	10-37, 10-48
Analog, Unpacked LSB Pad .....	10-43, 10-44
Analog, Unpacked MSB Pad .....	10-42
IRIG Time.....	10-32
PCM, Packed Mode .....	10-27
PCM, Throughput Mode.....	10-28
PCM, Unpacked Mode.....	10-25
PAM Attributes.....	9-64
PAM/FM.....	K-3
PAM/FM/FM.....	K-3
Parallel Channels .....	6-61
Parity bit .....	4-10
Partial word status.....	G-6
PCM Channels.....	6-58, 6-60
PCM codes.....	4-2, 4-3, 6-25
PCM data stream.....	9-31
PCM data word format .....	4-10
PCM Format Attributes .....	9-3, 9-4
PCM format attributes group .....	9-31, J-4
PCM input channels.....	L-5
PCM measurement description .....	9-4, 9-44, J-10
PCM recording.....	6-24
PCM signature .....	6-28
PCM signature recording .....	D-16
Percent power bandwidth.....	A-10
Phase equalizer .....	6-28
Physical channel number .....	G-5
Physical dimensions.....	6-43
Physical format .....	9-2
Physical recording density .....	6-5
Physical relationships .....	6-42
Plasticizing .....	7-3
Playback.....	D-15, D-17, D-18, D-19, D-21, D-22
Post-detection PCM recording.....	6-24
Preamble recording.....	6-29
Predetection .....	6-20, 6-22, 6-24
Premodulation filtering.....	K-4
Primary channel rate error .....	G-12
Primary data channel .....	6-37
Primary service .....	2-1
Principal block.....	6-5
Print through .....	7-2
Pulse amplitude modulator .....	F-1
Pulse amplitude modulator .....	F-4
Pulse code modulation.....	4-1, 6-22
Quadrature modulator.....	2-9
Quadrature transmission system.....	M-1
Quantizing noise variations .....	F-9, F-10
Radial clearance.....	7-5

Radio frequency.....	2-1
Radio frequency standards for telemetry.....	2-1
Range capability for FM subcarrier systems.....	B-4
Rate overrun.....	G-7
Receiver bandwidth.....	A-9, A-14
Receiver phase noise.....	2-16
Receivers and tape recorders.....	B-4
Reconstruction integrator.....	F-1, F-3, F-4, F-6
Record bandwidths.....	6-7
Record level.....	7-3, 7-8, 7-11
.....	D-15, D-16, D-18, D-19, D-20, D-21
Record level set frequency.....	6-5
Recorder mnemonics.....	6-62
Recorder alignment.....	6-29
Recorder analog data.....	10-38
Recorder commands.....	6-63, 6-65
Recorder data format.....	10-15
Recorder declassification.....	10-65
Recorder download port.....	10-5, 10-6
Recorder error codes.....	6-66
Recorder interface.....	10-6, 10-8
Recorder solid-state control.....	10-62
Recorder video packets.....	10-54, 10-56
Recorder/reproducer input.....	6-30
Recorder/reproducer input and output.....	6-30
Recorder/reproducer output.....	6-30
Recorders, on-board digital.....	10-1
Recording and playback alignment.....	D-21
Recording density.....	6-44
Recording geometry.....	6-43
Recording standards.....	6-29
Recursive Processing and Code Memory.....	xi, M-11
Reel characteristics.....	6-18, 6-22
Reels and hubs.....	7-5
Reference tape edge.....	6-5
Reference tape system.....	7-4
Reference track location.....	6-5
Relation of output to input.....	F-6
Reproduce bandwidths.....	6-7
Reproduce parameters.....	6-19, 6-22, 6-28
Reproduce-head segment.....	6-17
Resolution bandwidth.....	A-2, 2-4
Right subchannel over range.....	G-17
RNRZ-L.....	4-2, 6-25, D-8, D-9, D-10, D-11
S Band.....	2-3
Sample period.....	6-35, G-10, G-15, G-16
Scanner.....	6-5
Scatterwind.....	7-3, 7-8
Secondary service.....	2-2
Serial bit stream transitions.....	4-2
Serial Commands.....	10-63
Serial HDDR.....	6-24, 6-25, D-8, D-9
Serial high-density digital recording... See serial HDDR	
Servo track.....	6-44
Session start time.....	G-5
Setup Block Format.....	6-56
Shedding.....	7-3
Short term stability.....	K-3
Short wavelength output uniformity.....	7-3, 7-9
Signal source.....	5-1
Signature playback and analysis.....	D-20
Simultaneous operation.....	A-7
Sink process.....	10-4
SOQPSK-TG.....	xiv, 2-5, 2-9, 2-11
.....	A-2, A-5, A-6, A-7, A-9, A-10, A-15, A-16
.....	A-18, A-22, A-23, A-24, M-1, M-5, M-7
Source data base.....	H-1
Source signal.....	8-2
Spare field.....	G-5, G-9
Spectral equations.....	A-13
Spectral mask.....	A-16, A-17
Spectral occupancy.....	A-8, A-16
Speed control and compensation.....	6-24
Spurious emission.....	2-14
Spurious emissions.....	2-16
Spurious responses.....	2-17
Stale data bit.....	4-11
Standard record level.....	6-6
Subcommutation.....	4-6
Subframe.....	4-6
Subframe synchronization.....	4-6
Submultiple frame synchronization.....	K-4
Submultiplex.....	6-35
Submux FILL requirement.....	6-37
Supercommutation.....	4-6
Swept frequency.....	D-18, D-19
Syllabic filter.....	F-1, F-2, F-4, F-6
Symbol detectors.....	A-25, M-3
Symmetry.....	A-15
Sync Pattern.....	6-59
Sync patterns.....	6-48
System emissions.....	2-14
Table of Frequency Allocations.....	A-1, A-3
Tagged data format.....	4-7
Tape and cassettes.....	6-30
Tape cartridge.....	6-40, 6-46
Tape copying.....	6-28
Tape format.....	6-7
Tape guidance.....	6-18
Tape guiding.....	6-18
Tape reference edge.....	6-43
Tape signature recording.....	6-20
Tape skew.....	6-6
Tape Source Attributes.....	9-3, 9-16, 9-17, 9-18
Tape source attributes group.....	J-3
Tape speed.....	6-6, 6-19, 6-21, 6-22, 6-25, 6-26, 6-42, 6-44, 6-46
Tape speed control.....	3-5
Tape speeds.....	6-6, 6-22
Tape storing conditions.....	7-7
Tape width.....	6-7, 6-18
Technical standards.....	A-4
Telemetry attributes.....	9-1, 9-3

Telemetry bands .....	A-3	Transmitted frame counter .....	4-4
Throughput Data Mode, PCM .....	10-28	Transmitter antenna system emission testing.....	A-8
Time Code Channels .....	6-59	Transmitter phase noise .....	2-13
Time code field .....	G-4, G-5	UHF bands .....	2-2
Time delay .....	G-8, G-10, G-14	UHF telemetry receiver systems .....	2-16
Time tag.....	6-36, 8-5, 10-28, G-11, G-12	Ultra high frequency (UHF) telemetry bands .....	A-1
Time words .....	4-8, 8-5	Unpacked Data Mode	
Timing channel .....	G-11	Analog .....	10-42
Timing signal recording.....	6-20	PCM .....	10-25
TMATS.....	9-1, 9-2, 9-3, 9-8, 9-79	Upper band edge .....	7-3, 7-8, 7-9
Toxic compounds .....	7-5	Upper S Band.....	2-3
Track angle .....	6-6, 6-44	Variation of gain with input level .....	F-9
Track data azimuth difference .....	6-5	Version number .....	G-5
Track format .....	6-30	VHF telemetry .....	A-3
Track guard bands .....	6-44	Volume label.....	6-6
Track length.....	6-44	Wavelength response .....	7-3, 7-8, 7-9, 7-11, 7-12
Track location.....	6-5, 6-6	White noise .....	D-19
Track numbering.....	6-6, 6-16	Winding .....	7-5
Track pitch.....	6-43	Word count .....	G-6
Track spacing.....	6-6, 6-7	Word length .....	4-2
Track straightness.....	6-43	Word numbering.....	4-4
Track width.....	6-6, 6-7	Word structure .....	5-2, 8-1, 8-3, 8-8
Track widths .....	6-43	Word-oriented definitions.....	4-2
Transmission attributes .....	9-3, 9-10	Working length .....	7-4
Transmission attributes group.....	9-11, 9-12, J-3	Working reference tape.....	7-4
Transmission overhead .....	4-10		