



**TELEMETRY ATTRIBUTES TRANSFER STANDARD (TMATS)  
HANDBOOK**

**ABERDEEN TEST CENTER  
DUGWAY PROVING GROUND  
REAGAN TEST SITE  
REDSTONE TEST CENTER  
WHITE SANDS MISSILE RANGE  
YUMA PROVING GROUND**

**NAVAL AIR WARFARE CENTER AIRCRAFT DIVISION  
NAVAL AIR WARFARE CENTER WEAPONS DIVISION  
NAVAL UNDERSEA WARFARE CENTER DIVISION, KEYPORT  
NAVAL UNDERSEA WARFARE CENTER DIVISION, NEWPORT  
PACIFIC MISSILE RANGE FACILITY**

**30TH SPACE WING  
45TH SPACE WING  
96TH TEST WING  
412TH TEST WING  
ARNOLD ENGINEERING DEVELOPMENT COMPLEX**

**NATIONAL AERONAUTICS AND SPACE ADMINISTRATION**

**DISTRIBUTION A: APPROVED FOR PUBLIC RELEASE,  
DISTRIBUTION IS UNLIMITED**

This page intentionally left blank

**DOCUMENT 124-17**

**TELEMETRY ATTRIBUTES TRANSFER STANDARD (TMATS)  
HANDBOOK**

**January 2017**

**Prepared by**

**TELEMETRY GROUP  
DATA MULTIPLEX COMMITTEE**

**Published by**

**Secretariat  
Range Commanders Council  
U.S. Army White Sands Missile Range  
New Mexico 88002-5110**

This page intentionally left blank.

## Table of Contents

<b>Preface</b> .....	<b>ix</b>
<b>Acronyms</b> .....	<b>xi</b>
<b>Chapter 1. Introduction</b> .....	<b>1-1</b>
1.1 The Range Commanders Council and History of TMATS .....	1-1
1.2 Telemetry .....	1-2
<b>Chapter 2. Getting Started with a Simple Example</b> .....	<b>2-1</b>
2.1 A Simple Example .....	2-1
2.2 Attribute General Syntax and Semantics .....	2-6
2.3 A “Measurement” by Any Other Name.....	2-6
2.4 A “Look and Feel” Example.....	2-7
2.5 Attributes for the Look and Feel Example.....	2-18
2.6 Let’s Talk About Bits.....	2-19
2.6.1 Bit Masks. ....	2-19
2.6.2 Transfer Order.....	2-20
2.6.3 Fragment Order and Concatenation.....	2-21
<b>Chapter 3. Completing the Simple Example</b> .....	<b>3-1</b>
3.1 The General Information Group .....	3-1
3.2 The Transmission Attributes Group.....	3-4
3.3 The Multiplex/Modulation Attributes Group.....	3-5
3.4 The PCM Format Attributes Group .....	3-7
3.5 The PCM Measurement Description Group .....	3-16
3.6 The Data Conversion Attributes Group .....	3-20
3.7 The Completed TMATS File .....	3-23
<b>Chapter 4. General Structure and Groups</b> .....	<b>4-1</b>
<b>Chapter 5. More TMATS Examples</b> .....	<b>5-1</b>
5.1 Examples for Various Measurement Location Types.....	5-1
5.1.1 General Information.....	5-1
5.1.2 Measurement Examples.....	5-1
5.1.3 Additional Measurement Examples.....	5-13
5.2 Concatenation Examples.....	5-23
5.2.1 Example 1 .....	5-23
5.2.2 Example 2 .....	5-27
5.2.3 Summary of Concatenation Examples.....	5-31
5.3 Example of an Unevenly Spaced Measurement .....	5-31
5.4 Examples for Setting up Transmission Attributes .....	5-35

5.4.1	Source RF Attributes.....	5-35
5.4.2	Ground Station Attributes.....	5-41
5.5	Chapter 10 Recorder Examples .....	5-44
5.5.1	G-Group Example.....	5-45
5.5.2	R-Group Example.....	5-46
5.5.3	Sample Time Channel.....	5-49
5.5.4	Sample PCM Channel.....	5-51
5.5.5	Sample 1553 Channel.....	5-53
5.5.6	Sample Video Channel.....	5-58
5.5.7	P-Group Example.....	5-60
5.6	Packet Telemetry Downlink Example .....	5-63
5.6.1	Example 1 .....	5-63
5.6.2	Example 2 .....	5-64
5.7	Data Source ID and Data Link Name Clarifications .....	5-65
<b>Chapter 6. Adding a Simple Embedded Stream to the Simple Example.....</b>		<b>6-1</b>
<b>Appendix A. Extensible Markup Language TMATS Differences .....</b>		<b>A-1</b>
<b>Appendix B. Stuff People Should Never Have Done (But You Need To Be Able To Interpret).....</b>		<b>B-1</b>
<b>Appendix C. Glossary .....</b>		<b>C-1</b>
<b>Appendix D. References .....</b>		<b>D-1</b>

### List of Figures

Figure 1-1.	Telemetry System Components .....	1-3
Figure 2-1.	XML Snippet .....	2-2
Figure 2-2.	Components of an XML Element.....	2-3
Figure 2-3.	Example Schema Diagram.....	2-4
Figure 2-4.	POC Example XML.....	2-5
Figure 2-5.	POC Example XML Schema.....	2-5
Figure 2-6.	PCM Matrix .....	2-8
Figure 2-7.	Fundamental Synchronization Methods .....	2-8
Figure 2-8.	“Look and Feel” P-Group Example XML.....	2-10
Figure 2-9.	“Look and Feel” P-Group XML Schema.....	2-10
Figure 2-10.	“Look and Feel” P-Group Synchronization Example XML.....	2-11
Figure 2-11.	“Look and Feel” P-Group ID Counter XML Schema .....	2-12
Figure 2-12.	“Look and Feel” D-Group Measurement List Example XML .....	2-13
Figure 2-13.	“Look and Feel” D-Group Measurement List XML Schema.....	2-13
Figure 2-14.	“Look and Feel” D-Group Tire Pressure Measurement Example XML .....	2-14
Figure 2-15.	“Look and Feel” D-Group Measurement XML Schema .....	2-15

Figure 2-16.	“Look and Feel” D-Group Engine Temperature Measurement Example XML.....	2-16
Figure 2-17.	“Look and Feel” D-Group Tire Pressure Measurement Example XML .....	2-17
Figure 2-18.	“Look and Feel” D-Group Cabin Temperature Measurement Example .....	2-18
Figure 3-1.	General Information Group Example XML .....	3-3
Figure 3-2.	General Information Group Example XML Schema.....	3-3
Figure 3-3.	Transmission Attributes Group Example XML.....	3-4
Figure 3-4.	Transmission Attributes Group Example XML Schema.....	3-5
Figure 3-5.	Multiplex/Modulation Attributes Group Example XML.....	3-6
Figure 3-6.	Multiplex/Modulation Attributes Group Example XML Schema.....	3-6
Figure 3-7.	Attributes Used to Describe a PCM Format .....	3-7
Figure 3-8.	PCM Format Attributes Group Example XML .....	3-9
Figure 3-9.	PCM Format Attributes Group Example XML Schema.....	3-9
Figure 3-10.	PCM Format Attributes Group Example XML .....	3-11
Figure 3-11.	PCM Format Attributes Group Example XML Schema.....	3-12
Figure 3-12.	PCM Format Attributes Group Example XML .....	3-14
Figure 3-13.	PCM Format Attributes Group Example XML Schema.....	3-15
Figure 3-14.	Measurements Within the Major Frame .....	3-16
Figure 3-15.	Attributes Associated with Word and Frame.....	3-18
Figure 3-16.	PCM Measurement Description Group Example XML .....	3-19
Figure 3-17.	Data Conversion Attributes Group Example XML .....	3-22
Figure 3-18.	Data Conversion Attributes Group Example XML Schema .....	3-22
Figure 3-19.	The Completed TMATS File .....	3-23
Figure 4-1.	Group Relationships.....	4-2
Figure 5-1.	Minor Frame Measurement.....	5-2
Figure 5-2.	Minor Frame Measurement Example XML .....	5-3
Figure 5-3.	Minor Frame Supercommutated Measurement .....	5-4
Figure 5-4.	Minor Frame Supercommutated Measurement Example XML .....	5-5
Figure 5-5.	Minor Frame Fragmented Measurement .....	5-6
Figure 5-6.	Minor Frame Fragmented Measurement Example XML .....	5-7
Figure 5-7.	Subframe Measurement .....	5-8
Figure 5-8.	Subframe Measurement Example XML .....	5-9
Figure 5-9.	Subframe Supercommutated Measurement .....	5-10
Figure 5-10.	Subframe Supercommutated Measurement Example XML.....	5-11
Figure 5-11.	Subframe Fragmented Measurement .....	5-12
Figure 5-12.	Subframe Fragmented Measurement Example XML.....	5-13
Figure 5-13.	Subframe Fragmented Measurement in Multiple Locations (Location 1).....	5-14
Figure 5-14.	Subframe Fragmented Measurement in Multiple Locations (Location 2).....	5-14
Figure 5-15.	Subframe Fragmented Measurement in Multiple Locations (Location 1, Fragment 1).....	5-15
Figure 5-16.	Subframe Fragmented Measurement in Multiple Locations (Location 1, Fragment 2).....	5-16
Figure 5-17.	Subframe Fragmented Measurement in Multiple Locations (Location 1, Fragment 3).....	5-16
Figure 5-18.	Subframe Fragmented Measurement in Multiple Locations (Location 2, Fragment 1).....	5-17

Figure 5-19.	Subframe Fragmented Measurement in Multiple Locations (Location 2, Fragment 2).....	5-18
Figure 5-20.	Subframe Fragmented Measurement in Multiple Locations (Location 2, Fragment 3).....	5-18
Figure 5-21.	Subframe Fragmented Measurement in Multiple Locations Example XML ....	5-19
Figure 5-22.	Minor Frame Fragmented and Supercommutated Measurement (Two Locations) .....	5-20
Figure 5-23.	Minor Frame Fragmented and Supercommutated Measurement (Two Fragments in Each Location).....	5-21
Figure 5-24.	Minor Frame Fragmented and Supercommutated Measurement Example XML.....	5-23
Figure 5-25.	Concatenation Example 1: Two Words .....	5-24
Figure 5-26.	Concatenation Example #1 XML .....	5-26
Figure 5-27.	Data Conversion Example #1 XML .....	5-27
Figure 5-28.	Concatenation Example 2: Three Words .....	5-28
Figure 5-29.	Concatenation Example #2 XML .....	5-30
Figure 5-30.	Data Conversion Example #2 XML .....	5-31
Figure 5-31.	Unevenly Spaced Measurements .....	5-31
Figure 5-32.	Unevenly Spaced Measurement Example XML.....	5-34
Figure 5-33.	Transmission Attributes Group Example XML.....	5-39
Figure 5-34.	Transmission Attributes Group Example XML Schema .....	5-40
Figure 5-35.	Ground Station Attributes Group Example XML.....	5-42
Figure 5-36.	Ground Station Attributes Group Example XML Schema .....	5-43
Figure 5-37.	R-Group Example XML .....	5-47
Figure 5-38.	R-Group Example XML Schema.....	5-48
Figure 5-39.	R-Group Sample Time Channel Example XML .....	5-50
Figure 5-40.	R-Group Sample Time Channel Example XML Schema.....	5-50
Figure 5-41.	R-Group Sample PCM Channel Example XML .....	5-52
Figure 5-42.	R-Group Sample PCM Channel Example XML Schema.....	5-53
Figure 5-43.	R-Group Sample 1553 Channel Example XML.....	5-56
Figure 5-44.	R-Group Sample 1553 Channel Example XML Schema .....	5-57
Figure 5-45.	R-Group Sample Video Channel Example XML .....	5-59
Figure 5-46.	R-Group Sample Video Channel Example XML Schema .....	5-60
Figure 5-47.	“Look and Feel” P-Group Chapter 7 Example XML .....	5-63
Figure 5-48.	“Look and Feel” P-Group Chapter 7 XML Schema.....	5-64
Figure 5-49.	Data Source ID-Data Link Name Example .....	5-66
Figure 6-1.	Simple Embedded PCM Example .....	6-1
Figure B-1.	Worst Practice: Describing Every Frame Location .....	B-1
Figure B-2.	Best Practice: Using Frame Number and Frame Interval to Identify All Frame Locations.....	B-2

### List of Tables

Table 2-1.	POC Information XML element-TMATS code name pair.....	2-6
Table 2-2.	“Look and Feel” P-Group XML Element-TMATS Code Name Pair.....	2-10
Table 2-3.	“Look and Feel” P-Group ID Counter XML Element-TMATS Code Name Pair .....	2-12



Table 2-4.	“Look and Feel” D-Group Measurement List XML Element-TMATS Code Name Pair .....	2-13
Table 2-5.	“Look and Feel” D-Group Measurement XML Element-TMATS Code Name Pair.....	2-15
Table 2-6.	Structure of the PCM Major Frame .....	2-18
Table 2-7.	Contents of the PCM Major Frame.....	2-19
Table 3-1.	General Information Group XML Element-TMATS Code Name Pair .....	3-3
Table 3-2.	Transmission Attributes Group XML Element-TMATS Code Name Pair .....	3-5
Table 3-3.	Multiplex/Modulation Attributes Group XML Element-TMATS Code Name Pair.....	3-7
Table 3-4.	PCM Format Attributes Group XML Element-TMATS Code Name Pair.....	3-10
Table 3-5.	PCM Format Attributes Group XML Element-TMATS Code Name Pair.....	3-12
Table 3-6.	PCM Format Attributes Group XML Element-TMATS Code Name Pair.....	3-15
Table 3-7.	PCM Measurement Description Group XML Element-TMATS Code Name Pair.....	3-19
Table 3-8.	Data Conversion Attributes Group XML Element-TMATS Code Name Pair .....	3-22
Table 5-1.	Transmission Attributes Group XML Element-TMATS Code Name Pair .....	5-40
Table 5-2.	Ground Station Attributes Group XML Element-TMATS Code Name Pair ....	5-43
Table 5-3.	R-Group XML Element-TMATS Code Name Pair.....	5-48
Table 5-4.	R-Group Sample Time Channel XML Element-TMATS Code .....	5-50
Table 5-5.	R-Group Sample PCM Channel XML Element-TMATS Code Name Pair .....	5-53
Table 5-6.	R-Group Sample 1553 Channel XML Element-TMATS Code Name Pair .....	5-57
Table 5-7.	R-Group Sample Video Channel XML element-TMATS code name pair .....	5-60
Table 5-8.	Chapter 7 Packet Telemetry Data Frame Length.....	5-63
Table 5-9.	“Look and Feel” P-Group Chapter 7 XML Element-TMATS Code Name Pair .....	5-64
Table 5-10.	Calculating Chapter 7 Packet Telemetry Data Frame Length .....	5-65
Table B-1.	Worst and Best Practices of Using Word and Frame .....	B-2
Table B-2.	Worst and Best Practices for Combining Two Location Types .....	B-6
Table B-3.	Worst and Best Practices for Measurement Names .....	B-7
Table B-4.	Worst and Best Practices for “Filler” Measurements .....	B-7
Table B-5.	Worst and Best Practices for Listing Counter Attributes.....	B-8
Table B-6.	Worst and Best Practices for Grouping Attributes .....	B-9
Table B-7.	Worst and Best Practices for Using Indices to Group Related Attributes .....	B-10

This page intentionally left blank.

## Preface

This Telemetry Attributes Transfer Standard (TMATS) Handbook was prepared by the Data Multiplex Committee of the Telemetry Group (TG), Range Commanders Council (RCC). The TMATS Handbook is a common instrumentation reference for use by organizations that produce TMATS files, by ranges that receive TMATS files, and by vendors who incorporate TMATS files into their telemetry (TM) processing systems. The use of this handbook will eliminate inconsistencies and differing interpretations of TMATS files so that all parties will benefit from its usage.

The RCC gives special acknowledgement for production of this document to the TG Data Multiplex Committee. Please direct any questions to the committee point of contact (POC) or to the RCC Secretariat as shown below.

Chairman: Mr. Jon Morgan  
Representative, TG  
412 TW, Edwards AFB  
Bldg 1408 Room 5  
301 East Yeager  
Edwards AFB, CA 93524  
Phone: DSN 527-8942      Com (661) 277-8942  
Fax:    DSN 527-8933      Com (661) 277 8933  
email    [jon.morgan.2.ctr@us.af.mil](mailto:jon.morgan.2.ctr@us.af.mil)

Secretariat, Range Commanders Council  
ATTN: CSTE-WS-RCC  
1510 Headquarters Avenue  
White Sands Missile Range, New Mexico 88002-5110  
Phone: DSN 258-1107      Com (575) 678-1107  
Fax:    DSN 258-7519      Com (575) 678-7519  
email    [usarmy.wsmr.attec.list.rcc@mail.mil](mailto:usarmy.wsmr.attec.list.rcc@mail.mil)

This page intentionally left blank.

## Acronyms

ASCII	American Standard Code for Information Interchange
BCD	binary coded decimal
BER	bit error rate
Bi $\phi$ -L	bi-phase - level
Bi $\phi$ -M	bi-phase - mark
Bi $\phi$ -S	bi-phase - space
bps	bits per second
EU	engineering units
FM	frequency modulation
IF	intermediate frequency
IRIG	Inter-Range Instrumentation Group
kbps	kilobits per second
kHz	kilohertz
LHCP	left hand circular polarization
lsb	least significant bit
LSB	least significant byte
Mbps	megabits per second
MHz	megahertz
MIL-STD	Military Standard
msb	most significant bit
MSB	most significant byte
NRZ-L	non-return-to-zero - level
NRZ-M	non-return-to-zero - mark
NRZ-S	non-return-to-zero - space
PAM	pulse amplitude modulation
PCM	pulse code modulation
PM	phase modulation
PLL	phase-locked loop
POC	point of contact
RCC	Range Commanders Council
RF	radio frequency
RHCP	right hand circular polarization
RNRZ-L	randomized non-return-to-zero - level
TG	Telemetry Group
TM	telemetry
TMATS	Telemetry Attributes Transfer Standard
XML	eXtensible Markup Language

This page intentionally left blank.

## CHAPTER 1

### Introduction

This TMATS Handbook is intended to supplement Chapter 9<sup>1</sup> of RCC IRIG 106, Telemetry Standards. Practical guidance for properly generating and using TMATS files is provided and examples of some of the more commonly used TMATS features are given. Since there may be multiple ways of describing these features in TMATS, the examples are intended to illustrate best practices. The overall purpose of this handbook is to improve the use of TMATS as a standard by presenting clear guidelines and thereby eliminating any misinterpretations that may exist.

The RCC IRIG 106 sets forth standards for various aspects of TM data transmission, recording, and processing. These standards constitute a guide for the orderly implementation of TM systems and provide the necessary criteria on which to base equipment design and modification. Their purpose is to ensure efficient spectrum utilization, interference-free operation, interoperability between ranges, and compatibility of range user equipment at the ranges.

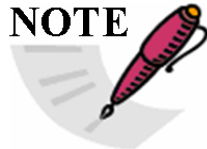
 <b>NOTE</b>	The RCC IRIG 106 is the master source of all information for TM data transmission, recording, and processing. Therefore, the RCC IRIG 106 is assumed to be correct if a discrepancy is found between it and this handbook. If a discrepancy is found, it should be immediately reported to the RCC Secretariat or to the TG. The RCC IRIG 106 can be viewed or downloaded from the RCC public web site, <a href="http://www.wsmr.army.mil/RCCsite/Pages/default.aspx">http://www.wsmr.army.mil/RCCsite/Pages/default.aspx</a> .
--	---

#### 1.1 The Range Commanders Council and History of TMATS

The RCC held its first meeting in August 1951. In March 1952, the RCC commanders established the Inter-Range Instrumentation Group (IRIG) to make recommendations for improvement of range instrumentation and conservation of the resources of the ranges. After a few meetings, the IRIG recognized the need to expand and specialize, and the IRIG Steering Committee was created to oversee several IRIG technical working groups. In 1971, the IRIG Steering Committee was disbanded, and the IRIG working groups became known as the RCC working groups. To this day, the RCC standards documents are still commonly referred to as IRIG standards.

The TMATS standard was developed jointly by the RCC TG Data Multiplex Committee and Data Reduction and Computer Group under a joint task begun in 1989. The standard was first published in 1993 as Chapter 9 of RCC IRIG 106. Since 1993, the Data Multiplex Committee has maintained this standard, with the primary goal of keeping it up to date with data types and features currently in use. Custom software tools were developed to work with the original “code name” TMATS format. In 2004, work began on a version of TMATS in the more widely used eXtensible Markup Language (XML) format. The initial version of a standard

---

<sup>1</sup> Range Commanders Council. Telemetry Standards. Chapter 9, Telemetry Attributes Transfer Standard. IRIG 106-15. July 2015. May be superseded by update. Retrieved 1 July 2015. Available at [http://www.wsmr.army.mil/RCCsite/Documents/106-15\\_Telemetry\\_Standards/Chapter9.pdf](http://www.wsmr.army.mil/RCCsite/Documents/106-15_Telemetry_Standards/Chapter9.pdf)

TMATS XML schema was published in 2007. Expressing TMATS in XML allows existing off-the-shelf XML software tools to be used to work with TMATS files. Both formats will be maintained for the foreseeable future.

The TMATS standard provides the common definition of the set of information needed to fully describe the data being transmitted from, or recorded on, an item under test. A TMATS file serves as the medium of exchange between the information source (usually an instrumentation organization) and the user (usually a test range).

The TMATS is not a data standard, but rather a description of existing data standards. For example:

- a. The TMATS description of pulse code modulation (PCM) data in the PCM Format Attributes Group (P-Group) and PCM Measurement Description Group (D-Group) is based on the standards for PCM data in RCC IRIG 106, Chapter 4.<sup>2</sup>
- b. The TMATS description of 1553 bus data in the P-Group and Bus Data Attributes Group (B-Group) is based on the standards for 1553 bus data in Military Standard (MIL-STD) 1553<sup>3</sup> and RCC IRIG 106, Chapter 8.<sup>4</sup>

As these data standards are modified and standards for new data types are created, the TMATS is also changed to reflect the improvements in the data standards.

The TMATS was developed to improve the process of getting the information needed to describe the TM data for a particular test from its source to the system being used to process the data. See RCC IRIG 106, Appendix H,<sup>5</sup> for a description of this process.

The TMATS files are usually produced and read by software. Automating this process reduces the time needed to prepare a TM processing system to support a test and eliminates errors that inevitably result from entering this information manually.

## 1.2 Telemetry

[Figure 1-1](#) illustrates just some of the different possible TM pathways from test item to analysis system.

---

<sup>2</sup> Range Commanders Council. "Pulse Code Modulation Standards," in *Telemetry Standards*. IRIG 106-15. July 2015. May be superseded by update. Retrieved 1 July 2015. Available at [http://www.wsmr.army.mil/RCCsite/Documents/106-15\\_Telemetry\\_Standards/chapter4.pdf](http://www.wsmr.army.mil/RCCsite/Documents/106-15_Telemetry_Standards/chapter4.pdf).

<sup>3</sup> Department of Defense. Aircraft Internal Time Division Command/Response Multiplex Data Bus. MIL-STD-1553B. 30 April 1975. May be superseded by update. Available at [http://quicksearch.dla.mil/qsDocDetails.aspx?ident\\_number=36973](http://quicksearch.dla.mil/qsDocDetails.aspx?ident_number=36973).

<sup>4</sup> Range Commanders Council. "Digital Data Bus Acquisition Formatting Standard," in *Telemetry Standards*. IRIG 106-15. July 2015. May be superseded by update. Retrieved 1 July 2015. Available at [http://www.wsmr.army.mil/RCCsite/Documents/106-15\\_Telemetry\\_Standards/chapter8.pdf](http://www.wsmr.army.mil/RCCsite/Documents/106-15_Telemetry_Standards/chapter8.pdf).

<sup>5</sup> Range Commanders Council. "Application of the Telemetry Attributes Transfer Standard," in *Telemetry Standards*. IRIG 106-15. July 2015. May be superseded by update. Retrieved 1 July 2015. Available at [http://www.wsmr.army.mil/RCCsite/Documents/106-15\\_Telemetry\\_Standards/appendixH.pdf](http://www.wsmr.army.mil/RCCsite/Documents/106-15_Telemetry_Standards/appendixH.pdf).



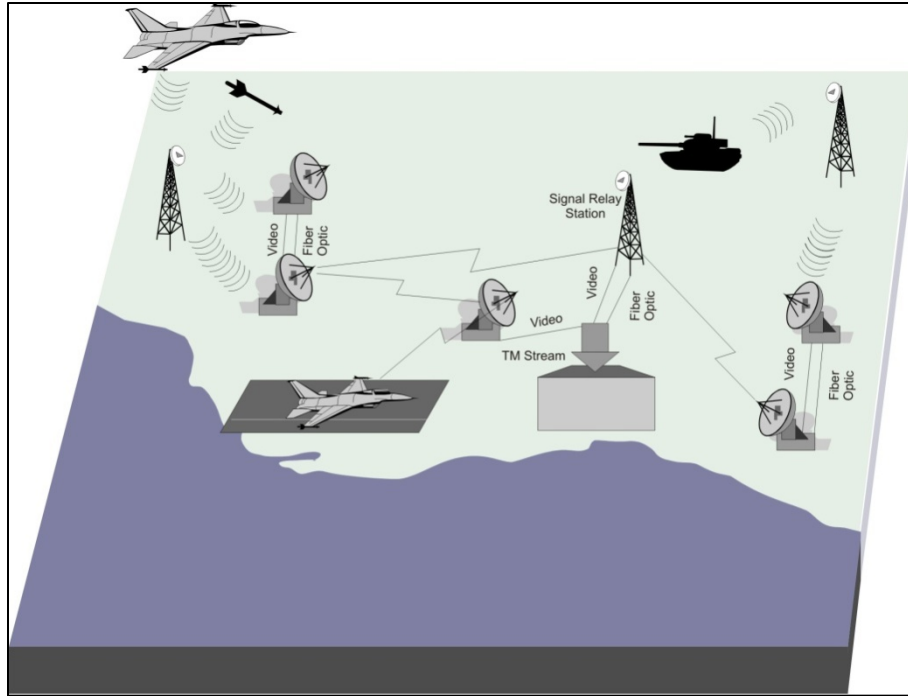

Figure 1-1. Telemetry System Components

The American Heritage Dictionary defines the term “telemetry” as:

*“The transmission of data by radio or other means from remote sources to receiving stations for recording and analysis.”*

The TM signals are formatted in what is commonly known as PCM. The TM signals containing data of interest, such as heading, air speed, altitude, voice, video, scientific information, and weather information, are transmitted from test items such as aircraft, weapons, ships, and ground vehicles.

Components of a basic TM system typically include:

- a. Signal transducers;
- b. Data acquisition system;
- c. Transmitter;
- d. Receiver;
- e. Telemetry processing system;
- f. Data display system.

With these systems, TM data can be transmitted over a radio link for retrieval at a ground station so that in-flight progress can be monitored.

This page intentionally left blank.

## CHAPTER 2

### Getting Started with a Simple Example

#### 2.1 A Simple Example

If you are reading this, then you probably have some idea what the TMATS is; but let's cover the basics, just in case. Let's start with "telemetry," which is the process of remotely collecting data. The normal application of the TMATS is for TM being transmitted using a radio signal from a test vehicle to a ground station where people are using the data to monitor what's happening on the vehicle. As the word "attributes" implies, TMATS is used to describe this signal.

At a very basic level, the two main things to describe are the signal characteristics and the details necessary to decipher the digitally encoded data being carried by that signal. The description of a particular signal is provided using a set of attributes - in the form of code name:value pairs - in an American Standard Code for Information Interchange (ASCII) text file or an XML file.

The XML specification is produced by the World Wide Web Consortium (W3C)<sup>6</sup> whose original intent was to provide a standard, machine-readable format for describing documents. Because of its popularity, wide adoption, and prevalence on the Internet, its use has expanded to describe arbitrary data structures such as web services and test and evaluation metadata. Here we provide a brief overview of XML. More detail can be found in the RCC Style Guide.<sup>7</sup>

The example in [Figure 2-1](#) shows a portion of an XML document (an XML snippet).

#### **A note about XML:**

This handbook uses the original syntax of TMATS, which was developed before XML was in general use. Since then, an XML version of TMATS has been published. The development of the XML version took a "transliteration" approach. That is, for the most part, there is a one-to-one mapping between the keywords in both syntaxes. [Appendix A](#) discusses the differences in more detail. But for now, this document will focus on the concepts and basic functionality provided by both.

---

<sup>6</sup> <http://www.w3.org/>

<sup>7</sup> Range Commanders Council. *XML Style Guide*. RCC 125-15. July 2015. Retrieved 13 January 2017. Available at [http://www.wsmr.army.mil/RCCsite/Documents/125-15\\_XML\\_Style\\_Guide/](http://www.wsmr.army.mil/RCCsite/Documents/125-15_XML_Style_Guide/).

```

<TmatsD:Measurement Name="TIREPRESSURE1">
  <TmatsD:Parity>Default</TmatsD:Parity>
  <TmatsD:MeasurementTransferOrder>Default</TmatsD:MeasurementTransferOrder>
  <TmatsD:LocationType>Word and Frame</TmatsD:LocationType>
  <TmatsD:WordAndFrame>
    <TmatsD:MeasurementLocation>
      <TmatsD:MeasurementFragments>
        <TmatsD:StartWord>2</TmatsD:StartWord>
        <TmatsD:EndWord>1</TmatsD:EndWord>
        <TmatsD:StartFrame>1</TmatsD:StartFrame>
        <TmatsD:EndFrame>1</TmatsD:EndFrame>
        <TmatsD:BitMask>Full Word</TmatsD:BitMask>
      </TmatsD:MeasurementFragments>
    </TmatsD:MeasurementLocation>
  </TmatsD:WordAndFrame>
</TmatsD:Measurement>

```

Figure 2-1. XML Snippet

In XML, each piece of data, or element, is surrounded by a “tag” such as `<TmatsD:Measurement>` and `<TmatsD:Parity>`. The structure of an XML file is such that tags can be enclosed in other tags to an arbitrary depth (`<TmatsD:MeasurementLocation>` is a sub-element of `<TmatsD:WordAndFrame>`, `<TmatsD:MeasurementFragments>` is a sub-element of `<TmatsD:MeasurementLocation>`, etc.). This is the basic idea behind the structure of an XML document.

The component parts of an XML element are identified in [Figure 2-2](#). Each of these components is defined below the figure.

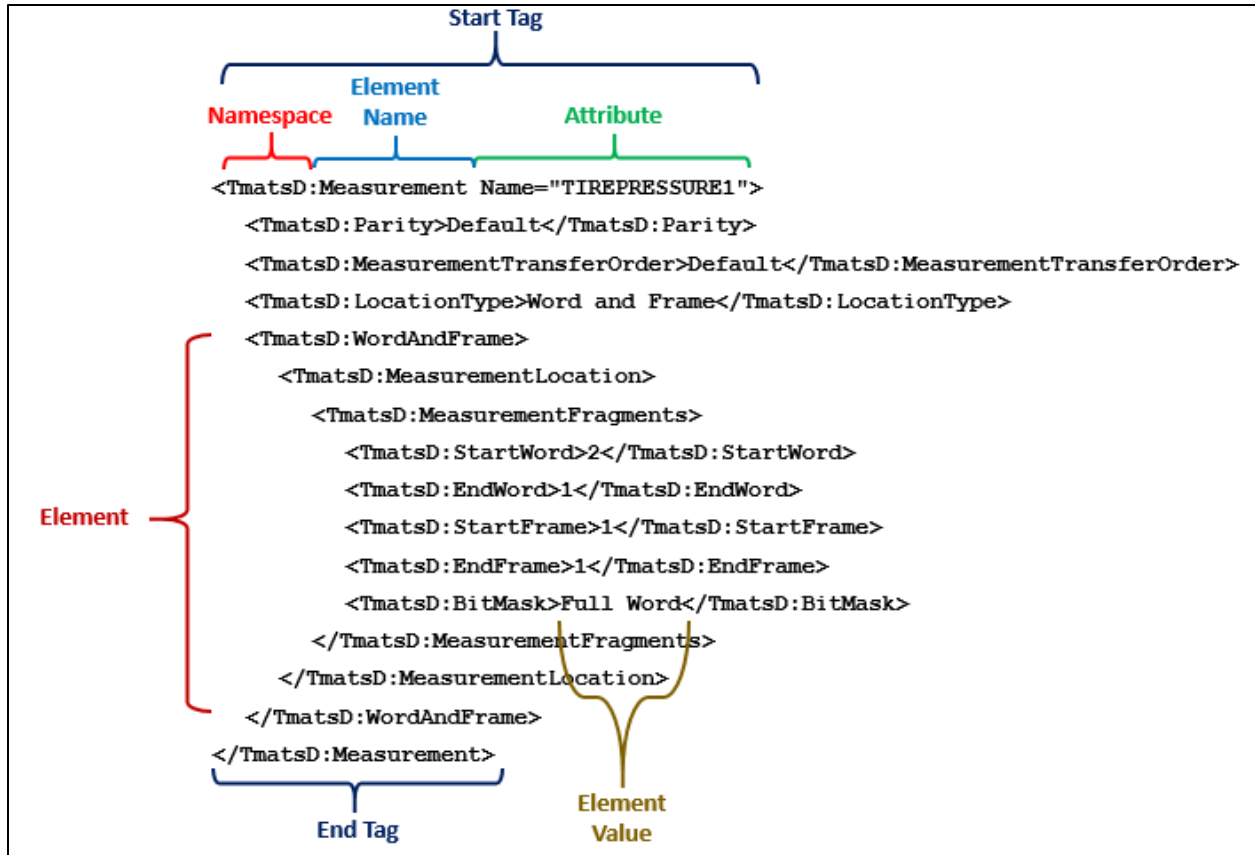

Figure 2-2. Components of an XML Element

- **Element:** “Element” is the term used to define a complete unit of XML information. It begins with a start tag and ends with an end tag. The value of an element can be a simple value or one or more sub-elements (children).
- **Start Tag:** The start tag identifies the beginning of the element and consists of the element’s name (and possibly a namespace and attributes) included between a “<” and a “>” symbol.
- **End Tag:** The end tag identifies the end of the element and looks identical to the start tag, except it includes a “/” (forward slash) after the “<” symbol. An end tag does not contain attributes.
- **Namespace:** The namespace is optional in XML, but can be used to define the scope within which the element is defined. In our TMATS example, we define a “TmatsD” namespace (for the TMATS D Group) and make all of the D Group elements members of it.
- **Element name:** The name of the element is what appears in the start and end tags and is what actually identifies the piece of information being defined.
- **Attribute:** Attributes are another method of associating information with an XML element. An attribute consists of a name followed by a “=” sign followed by a value enclosed in quotes.

- Element value:** The value of the element is everything that lies between the start tag and the end tag. The value can EITHER be a single value (e.g. 7, “John”, true, etc.) OR a collection of one or more sub-elements (children).

An XML schema is a design document used to describe a specific language that is based on XML. The rules for formatting proper XML are very simple and unrestricted. A schema defines which element names are valid, which elements can have which children, and which values are valid for each element. Types organize XML documents by defining the allowed structure for specific groupings of elements.

Even though an XML schema is itself a document, it is usually more useful to view the schema as a diagram. In this representation, boxes represent XML schema complex types (types that have structure). The bold title in the box is the name of the type. Inside the box, attributes are shown under the *Attributes* heading and simple types (types that do not have structure) are shown under the *Elements* heading. Elements that are complex types are represented by a line that connects the element with its type. The line is labeled with the name of the element. [Figure 2-3](#) contains an example schema diagram.

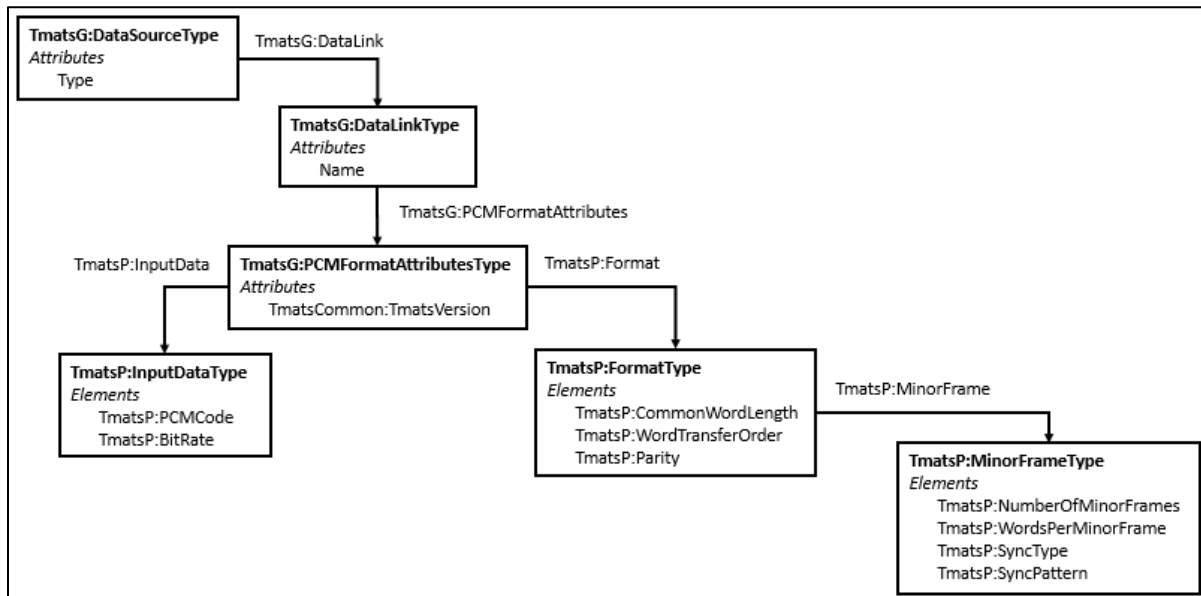

Figure 2-3. Example Schema Diagram

Throughout this presentation, raw TMATS XML examples will be shown alongside their respective ASCII text files in “code name” format. Even though the XML TMATS format is a transliteration of the TMATS code name format, there are a few exceptions that preclude an exact one-to-one mapping.<sup>8</sup> First, in XML, the element names are expanded for readability in the schema and are generally more descriptive than ASCII code names. Second, text entries in the XML schema may contain semicolons, while the code name format cannot because it uses the semicolon as a delimiter. Last, the inherent structure of an XML schema implies a standard order, while the code name format allows the attributes to be given in any order.

So without further ado, let’s look at an extremely simple TMATS file.

<sup>8</sup> For a complete list of XML exceptions, see [Appendix A](#).

- a. RCC IRIG 106 Revision Level. Identifies the RCC IRIG 106 version of TMATS used to generate the file. The format to describe a revision level is 106-xx, with xx as the last two digits of the year.

**G\106:09;**

- b. POC information.

- (1) Number of POCs. Identifies the number of POCs to be given.

**G\POC\N:1;**

- (2) POC Name. Identifies the name of the POC.

**G\POC1-1:Wile E. Coyote;**

- (3) POC Agency. Identifies the agency the named POC is associated with.

**G\POC2-1:ACME Corp;**

- (4) POC Address. Identifies the agency address.

**G\POC3-1:123 Roadrunner Way;**

- (5) POC Telephone. Identifies the named POC contact number.

**G\POC4-1:(555)555-5555;**

The XML snippet for the example above is shown in [Figure 2-4](#). [Figure 2-5](#) shows the relevant part of the XML schema in graphical form. [Table 2-1](#) shows the XML-to-TMATS code name mapping for this example.

```

<Tmats:Tmats TmatsG:TmatsVersion="106-13" ">
  <TmatsG:PointOfContact>
    <TmatsCommon:Name>Wile E. Coyote</TmatsCommon:Name>
    <TmatsCommon:Agency>ACME Corp</TmatsCommon:Agency>
    <TmatsCommon:Address>Roadrunner Way</TmatsCommon:Address>
    <TmatsCommon:Telephone>(555) 555-5555</TmatsCommon:Telephone>
  </TmatsG:PointOfContact>
</Tmats:Tmats>
    
```

Figure 2-4. POC Example XML

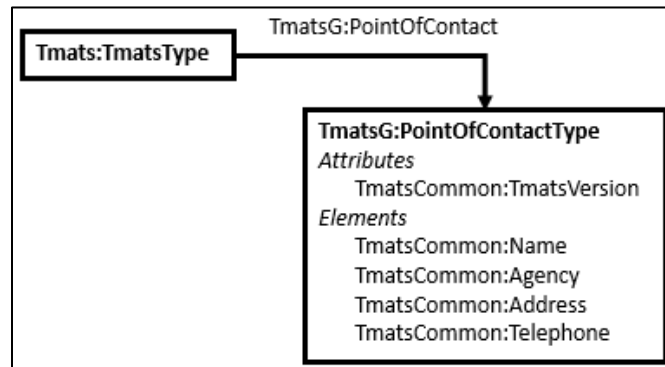

Figure 2-5. POC Example XML Schema

<b>Table 2-1. POC Information XML element-TMATS code name pair</b>	
<b>XML Element Relative to TmatsG:PointOfContact</b>	<b>Code Name</b>
TmatsCommon:Name	[G\POC1-n]
TmatsCommon:Agency	[G\POC2-n]
TmatsCommon:Address	[G\POC3-n]
TmatsCommon:Telephone	[G\POC4-n]

Now, that wasn't so bad, was it? Well, unfortunately, this example is not very useful because it does not actually describe anything... but it's a start.

## 2.2 Attribute General Syntax and Semantics

Before we consider a more meaningful example, let's get a general idea of what the contents of a TMATS file should look like. Each TMATS attribute consists of a unique code name and a data item. The code name appears first, delimited by a colon. The data item follows, delimited by a semicolon. Thus, an attribute appears as A:B; - where "A" is the code name and "B" is the data item.

There are two basic types of attribute code names: single-entry and multiple-entry. Single-entry attributes are those for which there is only one code name and one data item. Multiple-entry attributes have multiple indexed code names and data items, each of which corresponds to an index number. These attribute types allow for lists of like items, such as measurements.

a. Single-Entry Example. G\OD:05-11-2009;

The code name is "G\OD," which is "Origination Date"

The data item is "05-11-2009," which indicates May 11, 2009.

b. Multiple-Entry Example. G\DSI-2:AIRCRAFT\_DATA;

The code name is "G\DSI-2," which is "Data Source ID"

The index "2" specifies that this is the second data source ID.

The data item is "Aircraft Data," which is the identification of this data source.

Numeric values for data items may be either integer or decimal. Scientific notation is allowed only for those attributes specifically defined for its use. For alphanumeric data items, including keywords, either upper or lower case is allowed; TMATS is not case sensitive. Semicolons are not allowed in any data item, including comments. Leading, trailing, and embedded blanks are assumed to be intentional and must be accounted for if they appear within code names or data items. Carriage return (CR) and line feed (LF) may be used to improve readability.

## 2.3 A "Measurement" by Any Other Name...

You might not believe the number of person years that have been spent discussing the definition of "measurement." Other words that are related, or possibly mean the same thing



depending on who you ask, are: measurand, sample, parameter, and derived measurement. So let's look at the basic process to illustrate.

For this example, assume some raw phenomenon exists such as temperature, pressure, or velocity. You can also talk about discrete settings such as weight on wheels or other settings or values that are not necessarily physical phenomena; but let's start with just real-world things that we tend to measure. A sensor is placed somewhere to measure this phenomenon. Most sensors are analog devices that measure the phenomenon and produce a voltage output (actually, millivolt output). An analog-to-digital converter translates this voltage into a set of discrete bits. Usually, these bits are the ones that are telemetered. These bits are then converted using some algorithm into engineering units (EU) such as degrees Fahrenheit or furlongs per fortnight. The EU data is what engineers like to examine. Now consider that there isn't just one sample of each item, but rather a series of samples over time.

There are essentially four things involved here: the raw phenomenon, the voltage output of the sensor, the raw digitized data value, and the EU data. Well, there is something of a fifth thing in the sense that values of different phenomena might be used to derive another measurement. For example, a series of position and time samples might be used to derive velocity. Then the sixth thing is the full set of samples of a given phenomenon over time. Which of these is a measurement, sample, parameter, measurand, etc.?

A related terminology issue is the concept of "raw" data. Sticking our neck out a little, we'll say that this usually implies the non-EU digitized bits that are telemetered; but the term can be moved in either direction. That is, someone might refer to the "raw signal" meaning the voltage output of the sensor or, as used above, the "raw phenomenon"; or, occasionally, the initial EU data might be considered "raw" since the ultimate analysis is usually presented in some form derived from these low-level measurements. To add to the confusion, there are some people that talk about "generations" of data, implying that the initial digitized sensor output is a different generation from the EU or derived calculations.

In practice, the words measurement, measurand, sample, and parameter are often used interchangeably. The use of the term "raw" is probably sensitive to context; however, there are people and systems that make subtle distinctions between these words, so one must be careful. This handbook will use the word "measurement" for all of these words, and the word "raw" will not be used in this document.

## **2.4 A "Look and Feel" Example**

In order to illustrate how TMATS describes a signal, we'll use a simple example of a PCM matrix and show how it is described in TMATS; so we need to understand what a PCM matrix is. See page [2-9](#) for a note on PCM. A couple of key aspects of standard PCM are that the transmission is cyclic and, traditionally, the data transmitted is periodic. That is, a set of data in a standard sequence is repeated over and over during the transmission. This cyclic set of data and its sequence are what the PCM matrix describes. More specifically, the matrix is transmitted repeatedly by concatenating the rows of the matrix into a bit stream. Each cell inside the matrix represents a measurement. Simple examples of measurements include samplings of temperature and pressure. Most of the time, each measurement is measured and sent at a constant, periodic time interval. This periodicity continues across repeated cycles of the matrix; however, since we may desire to sample a physical phenomenon at a different rate than the matrix cycles, a

particular measurement may be repeated in a single matrix. Assume that the following PCM matrix shown in [Figure 2-6](#) is transmitted 25 times a second. Then the two tire pressures would be sent (and presumably sampled) 50 times a second.

Tire Pressure 1	Engine Temperature	Tire Pressure 2
Tire Pressure 1	Cabin Temperature	Tire Pressure 2

Figure 2-6. PCM Matrix

The above matrix would therefore be transmitted in a continuous bit stream in the following order:

Tire Pressure 1, Engine Temperature, Tire Pressure 2, Tire Pressure 1, Cabin Temperature, Tire Pressure 2, Tire Pressure 1, Engine Temperature ...

Unfortunately, practical considerations require adding overhead in the form of a known sequence of bits called a synchronization pattern (or just sync pattern) to be able to identify the beginning of the data. Backing up a little, consider that it is not normally the case that a TM stream is transmitted and the receiver receives every bit from start to finish. First, it is normal to have a bit error rate (BER) of about 1 in every million bits. Second, TM errors tend to be transmitted in bursts. For example, when a fighter jet rolls, the transmission path from the transmitter to the receiver may be blocked. The result would be a loss of, for example, 1013 bits all in a row. The use of sync patterns allows the receiver to pick up in the middle of a transmission and figure out where the data pattern begins.

*Best Practice - There are many more complicated ways to describe the position of a measurement in a PCM matrix. It is highly recommended that position is described using only word and frame. In fact, part of the reason for starting at this level in this handbook is to emphasize that this is the basic structure. Significantly deviating from this structure (as has been done) just makes life miserable for everyone involved.*

The basic sync process begins when a TM signal is acquired and bits start being recognized. A search is then started for the sync pattern. After it is found, you then check to see if the next sync pattern is in the appropriate place (i.e., the correct number of bits after the first sync). Once several (probably three) synchronization patterns at the proper spacing are recognized, you declare a frame lock. The two fundamental synchronization methods are minor frame and subframe synchronization (illustrated in [Figure 2-7](#)). For further explanation of minor frame synchronization and subframe synchronization, refer to RCC IRIG 106, Chapter 4.

	Word 1	Word 2	Word 3	Word 4	
Minor Frame 1	Minor frame synchronization	Subframe synchronization	TIREPRESSURE 1	ENGINE-TEMPERATURE	TIREPRESSURE2
Minor Frame 2	Minor frame synchronization	Subframe synchronization	TIREPRESSURE 1	CABIN-TEMPERATURE	TIREPRESSURE2

Figure 2-7. Fundamental Synchronization Methods

These overhead fields introduce the concepts of major frame, minor frame, and subframe. A major frame is the entire matrix (as shown in [Figure 2-7](#)). A minor frame (or just “frame”) is what a mathematician would call a row. A subframe keeps track of subcommutated measurements and will be discussed later. While we're discussing parts of the matrix, it is important to recognize that the word “*word*” is special and has two context-sensitive meanings. A word is either a cell in the matrix or, when used to describe position in the matrix, the word is the column. For example, Tire Pressure 1 is located in word 2, frame 1 and in word 2, frame 2. By convention, the first word after minor frame sync is designated as word 1.

Now, let's put this basic matrix structure into TMATS. We'll discuss the syntax and code names shortly, but this example gives the “look and feel” of TMATS.

```
P-1\DLN:PCM_STREAM;
P-1\D1:NRZ-L;
P-1\D2:2000000;
P-1\F1:16;
P-1\F2:M;
P-1\F3:NO;
P-1\MF\N:2;
P-1\MF1:5;
P-1\MF2:96;
P-1\MF3:FPT;
P-1\MF4:32;
P-
1\MF5:11111010111100110010000001110101;
```

The XML snippet for the example above is shown in [Figure 2-8](#). [Figure 2-9](#) shows the relevant part of the XML schema in graphical form. [Table 2-2](#) shows the XML-to-TMATS code name mapping for this example.

**A note on PCM:** Pulse Code Modulation (PCM) is, technically, a method for encoding bits on an RF signal. Since this was the most common modulation technique in the test community, PCM has become somewhat synonymous with telemetered data. A more generic term is Serial Streaming Telemetry (SST), as used by iNET. Even further, the terms “PCM matrix” or “PCM format” have become synonymous with the description of the bits in an SST. A more generic term is Data Cycle Map (DCM), but this is not commonly used. Since there are new modulation schemes, such as Shaped Offset Quadrature Phase Shift Keying (SOQPSK), that are used to transmit PCM or transmit a PCM format, there is potential for confusion. Although it may eventually go away, it looks like for the foreseeable future, PCM is going to be disassociated from its original meaning and we are likely to continue hearing people refer to things as “PCM” that are not pulse code modulated. In fact, it is not unusual for people to refer to a PCM file, meaning the recorded bits from an SST, which is a good example of the disassociation. So, the recommendation is to stop worrying about what “PCM” stands for and go with the flow.

```

<TmatsG:PCMFormatAttributes TmatsCommon:TmatsVersion="106-13">
  <TmatsP:InputData>
    <TmatsP:PCMCode>NRZ-L</TmatsP:PCMCode>
    <TmatsP:BitRate>2000000</TmatsP:BitRate>
  </TmatsP:InputData>
  <TmatsP:Format>
    <TmatsP:CommonWordLength>16</TmatsP:CommonWordLength>
    <TmatsP:WordTransferOrder>MSB First</TmatsP:WordTransferOrder>
    <TmatsP:Parity>None</TmatsP:Parity>
    <TmatsP:MinorFrame>
      <TmatsP:NumberOfMinorFrames>2</TmatsP:NumberOfMinorFrames>
      <TmatsP:WordsPerMinorFrame>5</TmatsP:WordsPerMinorFrame>
      <TmatsP:BitsPerMinorFrame>96</TmatsP:BitsPerMinorFrame>
      <TmatsP:SyncType>Fixed Pattern</TmatsP:SyncType>
      <TmatsP:SyncPattern>11111010111100110010000001110101</TmatsP:SyncPattern>
    </TmatsP:MinorFrame>
  </TmatsP:Format>
</TmatsG:PCMFormatAttributes>
    
```

Figure 2-8. “Look and Feel” P-Group Example XML

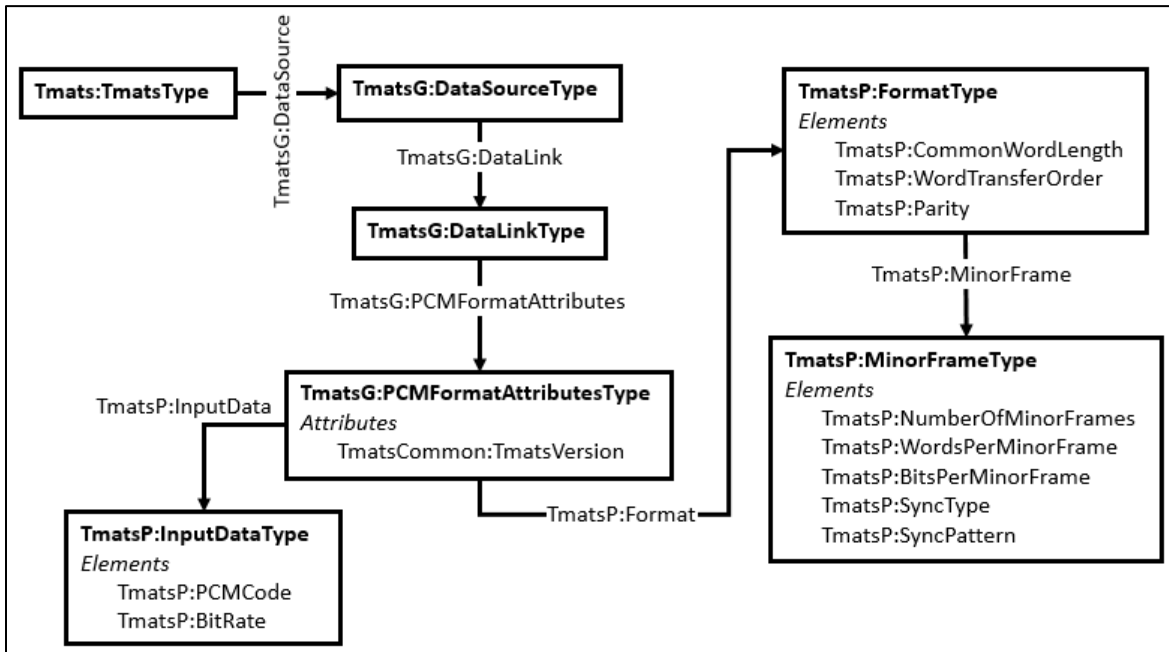

Figure 2-9. “Look and Feel” P-Group XML Schema

Table 2-2. “Look and Feel” P-Group XML Element-TMATS Code Name Pair	
XML Element Relative to TmatsP:PCMFormatAttributesTypes	Code Name
TmatsP:InputData/TmatsP:PCMCode	[P-d\D1]
TmatsP:InputData/TmatsP:BitRate	[P-d\D2]
TmatsP:Format/TmatsP:CommonWordLength	[P-d\F1]
TmatsP:Format/TmatsP:WordTransferOrder	[P-d\F2]
TmatsP:Format/TmatsP:Parity	[P-d\F3]

TmatsP:Format/TmatsP:MinorFrame\TmatsP:NumberOfMinorFrames	[P-d\MF\N]
TmatsP:Format/TmatsP:MinorFrame\TmatsP:WordsPerMinorFrame	[P-d\MF1]
TmatsP:Format/TmatsP:MinorFrame\TmatsP:BitsPerMinorFrame	[P-d\MF2]
TmatsP:Format/TmatsP:MinorFrame\TmatsP:SyncType	[P-d\MF3]
TmatsP:Format/TmatsP:MinorFrame\TmatsP:SyncPattern	[P-d\MF4]
TmatsP:Format/TmatsP:MinorFrame\TmatsP:SyncPattern	[P-d\MF5]

P-1\ISF\N:1;  
 P-1\ISF2:ID;  
 P-1\IDC1-1:1;  
 P-1\IDC3-1:16;  
 P-1\IDC4-1:1;  
 P-1\IDC5-1:D;  
 P-1\IDC6-1:0;  
 P-1\IDC7-1:1;  
 P-1\IDC8-1:1;  
 P-1\IDC9-1:2;  
 P-1\IDC10-1:INC;

The XML snippet for the example above is shown in [Figure 2-10](#). [Figure 2-11](#) shows the relevant part of the XML schema in graphical form. [Table 2-3](#) shows the XML-to-TMATS code name mapping for this example. The code [P-d\ISF\N] does not apply because the number of counters can be inferred from the structure of the schema.

```

<TmatsP:SubframeSynchronization>
  <TmatsP:IDCounter>
    <TmatsP:SyncType>ID Counter</TmatsP:SyncType>
    <TmatsP:Location>1</TmatsP:Location>
    <TmatsP:CounterStartingBitLocation>16</TmatsP:CounterStartingBitLocation>
    <TmatsP:CounterLength>1</TmatsP:CounterLength>
    <TmatsP:TransferOrder>Default</TmatsP:TransferOrder>
    <TmatsP:InitialValue>0</TmatsP:InitialValue>
    <TmatsP:InitialMinorFrameNumber>1</TmatsP:InitialMinorFrameNumber>
    <TmatsP:EndValue>1</TmatsP:EndValue>
    <TmatsP:EndMinorFrameNumber>2</TmatsP:EndMinorFrameNumber>
    <TmatsP:CountDirection>Increasing</TmatsP:CountDirection>
  </TmatsP:IDCounter>
</TmatsP:SubframeSynchronization>
  
```

Figure 2-10. “Look and Feel” P-Group Synchronization Example XML

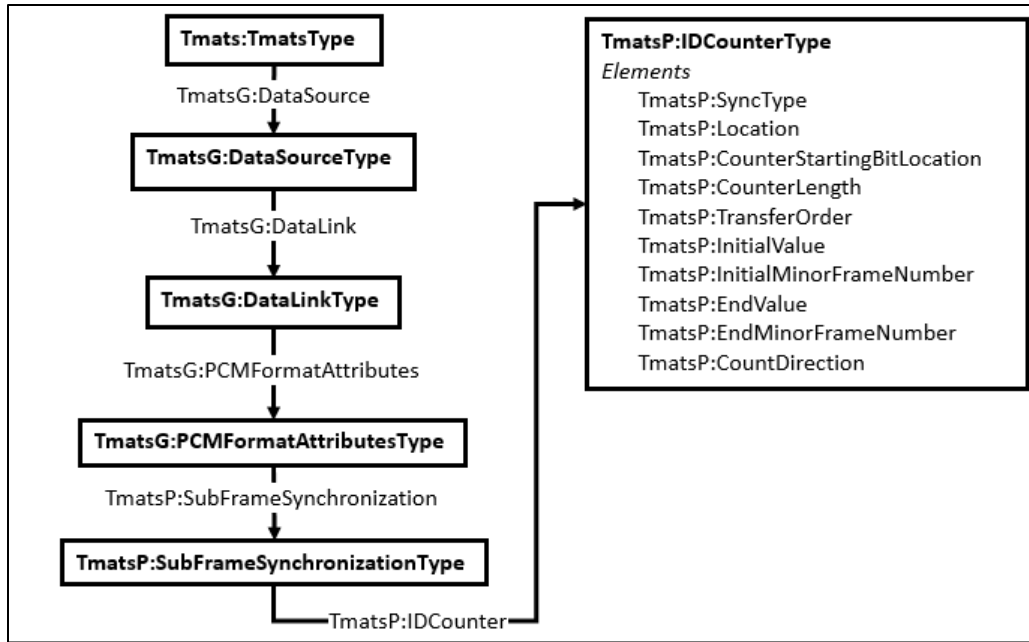

Figure 2-11. “Look and Feel” P-Group ID Counter XML Schema

Table 2-3. “Look and Feel” P-Group ID Counter XML Element-TMATS Code Name Pair	
XML Element Relative to TmatsP:PCMFormatAttributes/ TmatsP:SubframeSynchronization/TmatsP:IDCounter	Code Name
N/A	[P-d\ISF\N]
TmatsP:Name	[P-d\ISF1-n]
TmatsP:SyncType	[P-d\ISF2-n]
TmatsP:Location	[P-d\IDC1-n]
TmatsP:CounterStartingBitLocation	[P-d\IDC3-n]
TmatsP:CounterLength	[P-d\IDC4-n]
TmatsP:TransferOrder	[P-d\IDC5-n]
TmatsP:InitialValue	[P-d\IDC6-n]
TmatsP:InitialMinorFrameNumber	[P-d\IDC7-n]
TmatsP:EndValue	[P-d\IDC8-n]
TmatsP:EndMinorFrameNumber	[P-d\IDC9-n]
TmatsP:CountDirection	[P-d\IDC10-n]

D-1\DLN:PCM\_STREAM;  
 D-1\ML\N:1;  
 D-1\MLN-1:Measurement List;  
 D-1\MN\N-1:4;

The XML snippet for the example above is shown in [Figure 2-12](#). [Figure 2-13](#) shows the relevant part of the XML schema in graphical form. [Table 2-4](#) shows the XML-to-TMATS code name mapping for this example. The code [D-d\DNL] does not apply for the XML schema

because the data link name is inferred from the structure of the schema. The codes [D-d\ML\N] and [D-d\MN\N-n] do not apply because the number of measurement lists and number of measurements in a list can be inferred from the structure of the schema.

```

<TmatsG:DataLink Name="PCM STREAM">
  <TmatsG:PCMFormatAttributes TmatsCommon:TmatsVersion="106-13">
    <TmatsP:PCMMeasurements TmatsCommon:TmatsVersion="106-13">
      <TmatsD:MeasurementList Name="Measurement List">
        </TmatsD:MeasurementList>
      </TmatsP:PCMMeasurements>
    </TmatsG:PCMFormatAttributes>
  </TmatsG:DataLink>

```

Figure 2-12. “Look and Feel” D-Group Measurement List Example XML

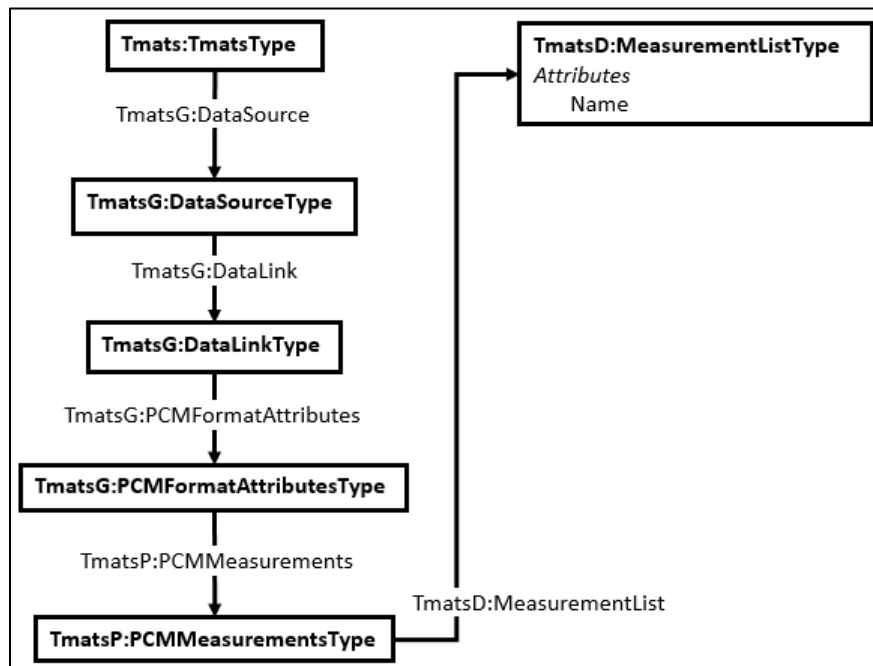

Figure 2-13. “Look and Feel” D-Group Measurement List XML Schema

Table 2-4. “Look and Feel” D-Group Measurement List XML Element-TMATS Code Name Pair	
XML Element Relative to TmatsP:PCMFormatAttributes/ TmatsP:PCMMeasurements	Code Name
N/A	[D-x\DLN]
N/A	[D-x\ML\N]
TmatsD:MeasurementList/Name	[D-x\MLN-y]
N/A	[D-x\MN\N-y]

D-1\MN-1-1:TIREPRESSURE1;  
D-1\MN1-1-1:DE;

D-1\MN2-1-1:D;  
 D-1\MN3-1-1:M;  
 D-1\LT-1-1:WDFR;  
 D-1\MML\N-1-1:1;  
 D-1\MNF\N-1-1-1:1;  
 D-1\WP-1-1-1-1:2;  
 D-1\WI-1-1-1-1:0;  
 D-1\FP-1-1-1-1:1;  
 D-1\FI-1-1-1-1:1;  
 D-1\WFM-1-1-1-1:FW;

The XML snippet for the example above is shown in [Figure 2-14](#). [Figure 2-15](#) shows the relevant part of the XML schema in graphical form. [Table 2-5](#) shows the XML-to-TMATS code name mapping for this example. The codes [D-x\MML\N-y-n] and [D-x\MNF\N-y-n-m] do not apply because the number of measurement locations and number of measurement fragments can be inferred from the structure of the schema.

```

<TmatsD:Measurement Name="TIREPRESSURE1">
  <TmatsD:Parity>Default</TmatsD:Parity>
  <TmatsD:ParityTransferOrder>Default</TmatsD:ParityTransferOrder>
  <TmatsD:MeasurementTransferOrder>MSB First</TmatsD:MeasurementTransferOrder>
  <TmatsD:LocationType>Word and Frame</TmatsD:LocationType>
  <TmatsD:WordAndFrame>
    <TmatsD:MeasurementLocation>
      <TmatsD:MeasurementFragments>
        <TmatsD:StartWord>2</TmatsD:StartWord>
        <TmatsD:WordInterval>0</TmatsD:WordInterval>
        <TmatsD:StartFrame>1</TmatsD:StartFrame>
        <TmatsD:FrameInterval>0</TmatsD:FrameInterval>
        <TmatsD:BitMask>Full Word</TmatsD:BitMask>
      </TmatsD:MeasurementFragments>
    </TmatsD:MeasurementLocation>
  </TmatsD:WordAndFrame>
</TmatsD:Measurement>
  
```

Figure 2-14. “Look and Feel” D-Group Tire Pressure Measurement Example XML



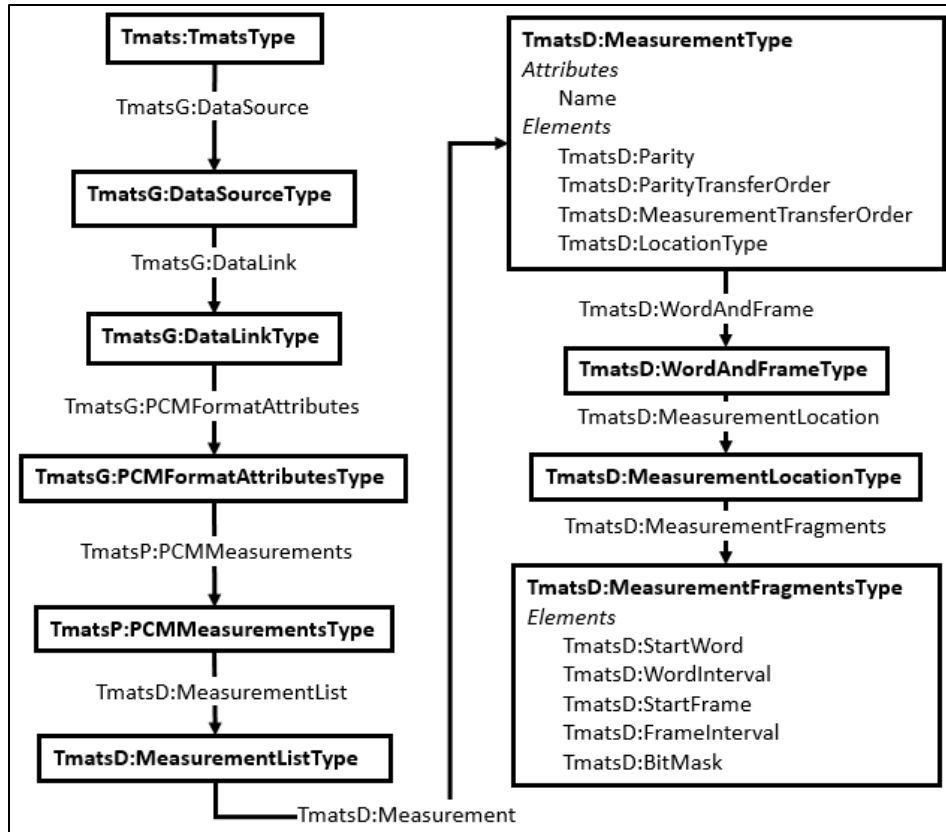

Figure 2-15. “Look and Feel” D-Group Measurement XML Schema

**Table 2-5. “Look and Feel” D-Group Measurement XML Element-TMATS Code Name Pair**

XML Element Relative to TmatsP:PCMFormatAttributes/ TmatsP:PCMMeasurements/ TmatsD:MeasurementList/ TmatsD:Measurement	Code Name
Name	[D-x\MN]
TmatsD:Parity	[D-x\MN1-y-n]
TmatsD:ParityTransferOrder	[D-x\MN2-y-n]
TmatsD:MeasurementTransferOrder	[D-x\MN3-y-n]
TmatsD:LocationType	[D-x\LT-y-n]
N/A	[D-x\MML\N-y-n]
N/A	[D-x\MNF\N-y-n-m]

<b>XML Element Relative to TmatsP:PCMFormatAttributes/ TmatsP:PCMMeasurements/ TmatsD:MeasurementList/ TmatsD:Measurement/ TmatsD:WordAndFrame/ TmatsD:MeasurementLocation</b>	
TmatsD:StartWord	[D-x\WP-y-n-m-e]
TmatsD:WordInterval	[D-x\WI-y-n-m-e]
TmatsD:StartFrame	[D-x\FP-y-n-m-e]
TmatsD:FrameInterval	[D-x\FI-y-n-m-e]
TmatsD:BitMask	[D-x\WFM-y-n-m-e]

D-1\MN-1-2:ENGINETEMPERATURE;  
 D-1\MN1-1-2:DE;  
 D-1\MN2-1-2:D;  
 D-1\MN3-1-2:M;  
 D-1\LT-1-2:WDFR;  
 D-1\MML\N-1-2:1;  
 D-1\MNF\N-1-2-1:1;  
 D-1\WP-1-2-1-1:3;  
 D-1\WI-1-2-1-1:0;  
 D-1\FP-1-2-1-1:1;  
 D-1\FI-1-2-1-1:0;  
 D-1\WFM-1-2-1-1:FW;

The XML snippet for the example above is shown in [Figure 2-16](#). [Figure 2-15](#) shows the relevant part of the XML schema in graphical form. [Table 2-5](#) shows the XML-to-TMATS code name mapping for this example.

```

<TmatsD:Measurement Name="ENGINETEMPERATURE">
  <TmatsD:Parity>Default</TmatsD:Parity>
  <TmatsD:ParityTransferOrder>Default</TmatsD:ParityTransferOrder>
  <TmatsD:MeasurementTransferOrder>MSB First</TmatsD:MeasurementTransferOrder>
  <TmatsD:LocationType>Word and Frame</TmatsD:LocationType>
  <TmatsD:WordAndFrame>
    <TmatsD:MeasurementLocation>
      <TmatsD:MeasurementFragments>
        <TmatsD:StartWord>3</TmatsD:StartWord>
        <TmatsD:WordInterval>0</TmatsD:WordInterval>
        <TmatsD:StartFrame>1</TmatsD:StartFrame>
        <TmatsD:FrameInterval>0</TmatsD:FrameInterval>
        <TmatsD:BitMask>Full Word</TmatsD:BitMask>
      </TmatsD:MeasurementFragments>
    </TmatsD:MeasurementLocation>
  </TmatsD:WordAndFrame>
</TmatsD:Measurement>
  
```

Figure 2-16. “Look and Feel” D-Group Engine Temperature Measurement Example XML

D-1\MN-1-3:TIREPRESSURE2;  
 D-1\MN1-1-3:DE;  
 D-1\MN2-1-3:D;  
 D-1\MN3-1-3:M;  
 D-1\LT-1-3:WDFR;  
 D-1\MML\N-1-3:1;  
 D-1\MNF\N-1-3-1:1;  
 D-1\WP-1-3-1-1:4;  
 D-1\WI-1-3-1-1:0;  
 D-1\FP-1-3-1-1:1;  
 D-1\FI-1-3-1-1:1;  
 D-1\WFM-1-3-1-1:FW;

The XML snippet for the example above is shown in [Figure 2-17](#). [Figure 2-15](#) shows the relevant part of the XML schema in graphical form. [Table 2-5](#) shows the XML-to-TMATS code name mapping for this example.

```

<TmatsD:Measurement Name="TIREPRESSURE2">
  <TmatsD:Parity>Default</TmatsD:Parity>
  <TmatsD:ParityTransferOrder>Default</TmatsD:ParityTransferOrder>
  <TmatsD:MeasurementTransferOrder>MSB First</TmatsD:MeasurementTransferOrder>
  <TmatsD:LocationType>Word and Frame</TmatsD:LocationType>
  <TmatsD:WordAndFrame>
    <TmatsD:MeasurementLocation>
      <TmatsD:MeasurementFragments>
        <TmatsD:StartWord>1</TmatsD:StartWord>
        <TmatsD:WordInterval>0</TmatsD:WordInterval>
        <TmatsD:StartFrame>1</TmatsD:StartFrame>
        <TmatsD:FrameInterval>0</TmatsD:FrameInterval>
        <TmatsD:BitMask>Full Word</TmatsD:BitMask>
      </TmatsD:MeasurementFragments>
    </TmatsD:MeasurementLocation>
  </TmatsD:WordAndFrame>
</TmatsD:Measurement>
  
```

Figure 2-17. “Look and Feel” D-Group Tire Pressure Measurement Example XML

D-1\MN-1-4:CABINTEMPERATURE;  
 D-1\MN1-1-4:DE;  
 D-1\MN2-1-4:D;  
 D-1\MN3-1-4:M;  
 D-1\LT-1-4:WDFR;  
 D-1\MML\N-1-4:1;  
 D-1\MNF\N-1-4-1:1;  
 D-1\WP-1-4-1-1:3;  
 D-1\WI-1-4-1-1:0;  
 D-1\FP-1-4-1-1:2;  
 D-1\FI-1-4-1-1:0;  
 D-1\WFM-1-4-1-1:FW;

The XML snippet for the example above is shown in [Figure 2-18](#). [Figure 2-15](#) shows the relevant part of the XML schema in graphical form. [Table 2-5](#) shows the XML-to-TMATS code name mapping for this example.

```
<TmatsD:Measurement Name="CABINTEMPERATURE">
  <TmatsD:Parity>Default</TmatsD:Parity>
  <TmatsD:ParityTransferOrder>Default</TmatsD:ParityTransferOrder>
  <TmatsD:MeasurementTransferOrder>Default</TmatsD:MeasurementTransferOrder>
  <TmatsD:LocationType>Word and Frame</TmatsD:LocationType>
  <TmatsD:WordAndFrame>
    <TmatsD:MeasurementLocation>
      <TmatsD:MeasurementFragments>
        <TmatsD:StartWord>3</TmatsD:StartWord>
        <TmatsD:WordInterval>0</TmatsD:WordInterval>
        <TmatsD:StartFrame>2</TmatsD:StartFrame>
        <TmatsD:FrameInterval>0</TmatsD:FrameInterval>
        <TmatsD:BitMask>Full Word</TmatsD:BitMask>
      </TmatsD:MeasurementFragments>
    </TmatsD:MeasurementLocation>
  </TmatsD:WordAndFrame>
</TmatsD:Measurement>
```

Figure 2-18. “Look and Feel” D-Group Cabin Temperature Measurement Example

## 2.5 Attributes for the Look and Feel Example

The basics of what the TMATS file for our example is telling us are described in [Table 2-6](#) and [Table 2-7](#). Details about the meaning of each attribute in the example are in [Chapter 3](#). The first set of attributes, which begin with the letter “P,” describes the structure of the PCM major frame.

<b>Attribute</b>	<b>Description</b>
P-1\DLN	A name that identifies this stream of data.
P-1\D1 and P-1\D2	The encoding and data rate.
P-1\F1, P-1\F2, and P-1\F3	General format information: common word length, transfer order (which bit is the first bit transmitted), and parity, respectively.
P-1\MF\N	Number of minor frames (rows) in the major frame.
P-1\MF1 and P-1\MF2	The length of the minor frame in words and bits, respectively.
P-1\MF3, P-1\MF4, and P-1\MF5	Description of the minor frame sync pattern.
P-1\ISF\N, P-1\ISF2, and the attributes starting with P-1\IDC	Description of the subframe sync method, which is almost always a subframe ID counter.

The second set of attributes, which begin with the letter “D,” describes the contents of the PCM major frame (where the measurements are located).

**Table 2-7. Contents of the PCM Major Frame**

Attribute	Description
D-1\MLN	A name that identifies this measurement list.
D-1\MN\N	Number of measurements in this measurement list (four in this case).
D-1\MN	The name that identifies a particular measurement.
D-1\MN1 and D-1\MN2	Parity type and location within the measurement.
D-1\MN3	The measurement's transfer order (which bit is the first bit transmitted).
D-1\LT	This attribute tells how to locate this measurement within the major frame. The measurements in this example use the "word and frame" location type.
D-1\MML\N	The number of location definitions given (only one in this case).
D-1\MNF\N	This attribute tells if the measurement is fragmented and, if so, the number of fragments. In this case, the value "1" says it is not fragmented.
D-1\WP and D-1\WI	Word position and word interval.
D-1\FP and D-1\FI	Frame position and frame interval.
D-1\WFM	This attribute tells if any bits are to be masked out. In this case, the value "FW" says that the full word is used.

## 2.6 Let's Talk About Bits

 <p><b>NOTE</b></p>	<p>TO DECODE PCM PROPERLY, we need to know exactly how each piece of information is mapped out. In TMATS, each piece of information is called a "measurement."</p> <p>THERE IS A BASIC SET OF PROPERTIES THAT:</p> <p><u>DEFINE</u> which bits in the PCM stream belong to a particular measurement; and <u>DESCRIBE</u> how these bits are organized.</p>
--	--

In this section, the reader is assumed to be familiar with conversion between binary, decimal, and hexadecimal numbers and with bitwise operations. Hexadecimal numbers in this document will be preceded by the letters 0x (e.g., 0x1111 or 0xAAAA ).

The acronyms MSB and LSB can mean either most (least) significant bit or byte, depending on the context. In this section, the convention is that capital letters refer to bytes and lower-case letters to bits. So MSB means most significant byte and msb means most significant bit (and likewise for LSB/lb).

### 2.6.1 Bit Masks.

The concept of a bit mask is used by TMATS to identify which bits in a particular data word belong to the measurement in question. A bit mask is a number represented in a binary format that when combined with the data word by a bitwise AND operation yields the bits that belong to the measurement. In the examples for this section, however, we will be using the hexadecimal representation of the bit mask for brevity. More information on bitwise operations is at [http://en.wikipedia.org/wiki/Bitwise\\_AND](http://en.wikipedia.org/wiki/Bitwise_AND).

In this document, the bitwise AND operator is represented by the ampersand sign (&). Two examples follow.

- a. If the bit mask is 0x0FF0, and you have the 16-bit data word 0xFFFF, then:

$$0x0FF0 \& 0xFFFF = 0x0FF0$$

- b. If the bit mask is 0x0FF0, but you have the 16-bit data word 0xBAAD, then:

$$0x0FF0 \& 0xBAAD = 0x0AA0$$

### 2.6.2 Transfer Order.

In TMATS, the concept of a mask carries an additional implied bit shift operation to align the lsb. In order to apply the mask and shift correctly one needs to know the transfer order of the data word in question. Sometimes “transfer order” is also referred to as “bit orientation” or “bit justification.”

Consider a binary number that can be described as:

$$p_n 2^n + p_{n-1} 2^{n-1} + \dots p_0$$

Where:

$n$  = the number of bits – 1 and

$p_i$  = 1 or 0 for  $0 \leq i \leq n$ .

The msb is the bit position that corresponds to  $p_n$  and the lsb is the bit position that corresponds to  $p_0$ . In other words, msb is the bit position that carries the most value and lsb is the bit position that carries the least value.

**Example:** This TMATS attribute defines the bit mask of measurement 3 in measurement list 2 of data link 1 as 0x7F. The mask denotes bits 2 to 8, using the RCC IRIG 106, Chapter 4 convention that “the most significant bit in a word shall be numbered ‘one’.”

D-1\WFM-2-3:01111111;

If the msb of a word is transmitted first, TMATS calls the transfer order “M” meaning the msb appears transmitted first in the serial stream; likewise if the lsb of a word is transmitted first, TMATS calls it “L.” So, if a word is transmitted msb first, the binary number 1101 would have a decimal value of 13 but if that same word were transmitted lsb first ( i.e. 1011), the decimal value would be 11. The assumption in TMATS is that bits are transmitted in order, from lsb to msb or msb to lsb. Transfer order can be “inherited” from the parent data link. In this case, TMATS uses transfer order “D” for default.

 <p><b>NOTE</b></p>	<p>The mask is always interpreted as msb first, so the order of the bits must be reversed before applying the mask if the bits are transmitted lsb first.</p>
--	---

Using a mask and transfer order may seem difficult to grasp at first. In other systems, the bit numbering nomenclature might not rely on a mask and transfer order but rather a range of bit positions such as “bits 4-10” or “B11:5.” But this methodology is inherently imprecise because in addition to the transfer order the user must know:

1. What is the lsb counting number (0? 1? Other?)
2. If the lsb counting number is not 0 or 1, what is the msb counting number (0? 1?)
3. Is the range meant to be inclusive or exclusive?

Now that the transfer order is understood, the implied bit shift operation can be performed. Words that are transmitted msb first would be shifted right for as many bits as necessary to guarantee that the lsb of the word would then be positioned in the p<sub>0</sub> position of the word. Words that are transmitted lsb first must be reversed into msb first order and then have the mask/shift applied. For example, if the data word = 0x1AAB and the mask = 0x1FF0 then in the msb first case, the mask is applied:

$$0x1AAB \& 0x1FF0 = 0x1AA0$$

and the result is shifted right 4 bits:

$$0x01AA$$

In the lsb-first case, the bits are first reversed:

$$0xD558$$

and then the mask/shift is applied:

$$0xD558 \& 0x1FF0 = 0x1550 \rightarrow 0x0155$$

Here are some additional examples:

TMATS attribute defining a transfer order and bit mask of 0x7F0 for fragment 1 at location 1 of measurement 3 in measurement list 2 of data link 1, which would represent bits 2 through 8 of a 12-bit word:

```
D-1\WFM-2-3-1-1:011111110000;
D-1\WFT-2-3-1-1:M;
```

TMATS attribute defining the same measurement but transmitted lsb first. Note the change in the mask, which is now 0xFE.

```
D-1\WFM-2-3-1-1:000011111110;
D-1\WFT-2-3-1-1:L;
```

TMATS attribute defining a default transfer order and the full word for fragment 1 at location 1 of measurement 3 in measurement list 2 of data link 1.

```
D-1\WFM-2-3-1-1:FW;
D-1\WFT-2-3-1-1:D;
```

### 2.6.3 Fragment Order and Concatenation.

Sometimes a measurement may require that bits be noncontiguous. Contiguous bits that come from a single word are known as a fragment. A measurement is reconstructed by concatenating fragments. To accurately describe this concatenation, in addition to bit masks and bit transfer order of each fragment, we need to know the fragment position. Fragment position is a data-link-specific numbering convention, usually 1-based, that indicates the order in which the fragments are to be concatenated in order to reconstruct the measurement. Fragment position = 1

#### A Word on Endianness

Computer architectures differ in their native representation of binary data. Some organize binary data so that the LSB appears first in the transfer order. This is called “little endian.” Some organize it so that the MSB appears first in the transfer order. This is called “big endian.” Intel-based personal computers and their clones are an example of a little-endian architecture. Please note that this refers to the transfer order of the **bytes** and not the transfer order of the **bits** contained therein. In nearly all architectures, the bit transfer order is still msb first.

This obviously can impact the translation of a measurement. For example, if a 16-bit data word with a value of 0x1234 is encoded in PCM as msb first, in order to accurately translate it to a 16-bit integer on a little-endian system, you would need to swap the bytes (0x3412) before you interpreted that memory as 16-bit integer. Likewise, a 32-bit data word with a value of 0x11223344 would have to be byte-swapped to 0x44332211 in order to accurately translate it to a 32-bit integer on a little-endian system.

indicates the most significant fragment. The masks and the transfer order must be applied before the concatenation.

Consider this example for location 1 of measurement 3 in measurement list 2 of data link 1:

D-1\WFM-2-3-1-1:**111111110000**;  
D-1\WFT-2-3-1-1:**M**;  
D-1\WFP-2-3-1-1:**1**;  
D-1\WFM-2-3-1-2:**111100000000**;  
D-1\WFT-2-3-1-2:**M**;  
D-1\WFP-2-3-1-2:**2**;

Fragment 1 has a mask of 0xFF0 and fragment 2 has a mask of 0xF00; so if data word 1 has a value of 0xAAA and data word 2 has a value of 0xBBB then after applying the masks and concatenating you would be left with 0xAAB as the binary value for the measurement.

#### **KEY POINTS**

- A binary mask with an implied shift is the method for describing the bits of interest in TMATS.
- Transfer order is significant. Measurements that are transmitted lsb first must be reversed to msb first before a mask can be applied.
- Word transfer order is also significant. Multiple words may need to be concatenated in order to achieve the final measurement.
- The msb in TMATS is the left-most bit in the drawing.
- The lsb in TMATS is to the right-most bit in the drawing.
- FW represents all bits in the specified word that may or may not be the common word length. For example, FW for a word length of 12 bits is actually 0xff.



## CHAPTER 3

### Completing the Simple Example

The example in [Chapter 2](#) described a TMATS structure; there are several more pieces of the description that need to be included. As these pieces are added, we will need to include attributes from different groups of TMATS. An overview of the groups will be provided later in [Chapter 4](#), but first we will finish a complete example.

For a simple TMATS file, we will describe PCM data from the “look and feel” example of Section [2.4](#) with these added attributes:

- a. Bit Rate.        2 megabits per second (MBps)
- b. Frame Sync Pattern.    FAF32075
- c. Common Word Length.     16 bits
- d. All measurements.    2’s complement
- e. All measurements.    → Gain = .0025        Offset = -5.12
- f. Transmitter Operating Frequency.    2251.5 megahertz (MHz)
- g. Transmitter Modulation type.        Frequency modulation

#### 3.1 The General Information Group

The General Information Group (G-Group) documents general information about the overall program, such as program or project name, type of test item, POC, date a TMATS file was generated, date a TMATS file was updated, and security classification information. There is only one G-Group in a TMATS file.

- a. Program Name. The program or project name.  
**G\PN:TEST\_XYZ;**
- b. Test Article. The name, model, platform, or identifier of the test item as appropriate.  
**G\TA:F16;**
- c. RCC IRIG 106 Revision Level. The RCC IRIG 106 version year that the TMATS file was based upon. The format to describe version is 106-xx, with xx being the last two digits of the year.  
**G\106:09;**
- d. Origination Date. The date on which the TMATS file was first generated or originated. The date must be in MM-DD-YYYY format.  
**G\OD:10-22-2009;**
- e. POC information.
  - (1) Number of POCs. The number of POCs to be given.  
**G\POC\N:1;**
  - (2) POC Name. Name of the POC.  
**G\POC1-1:Wile E. Coyote;**

- (3) POC Agency. The agency the named POC is associated with.  
**G\POC2-1:ACME Corp;**
- (4) POC Address. The agency address.  
**G\POC3-1:123 Roadrunner Way;**
- (5) POC Telephone. The POC contact telephone number.  
**G\POC4-1:(555) 555-5555;**
- f. Number of Data Sources. The number of data source IDs for the radio frequency (RF) TM system or tape/storage system. If an RF system is specified, then the number of carriers will need to be identified. If a tape/storage system is specified, the number of tape/storage sources will need to be identified.  
**G\DSI\N:1;**
- g. Data Source ID. A descriptive name for the data source. This is used to link the G-Group back to the data source ID from the Transmission Attributes Group (T-Group) and must match the data item T-x\ID and from the Multiplexing/Modulation Attributes Group (M-Group) and must match the data item M-x\ID.  
**G\DSI-1:RF\_DATA\_SOURCE;**
- h. Data Source Type. The type of data source, such as, RF (RF), Tape (TAP), Storage (STO), Distributed Source (DSS), Direct Source (DRS), Reproducer (REP), or Other (OTH).  
**G\DST-1:RF;**
- i. Security Classification. The security classification for the project data, such as Unclassified (U), Confidential (C), Secret (S), Top Secret (T), or Other (O). If the project data is considered classified, then information regarding the project's security classification guide and/or downgrading information should be provided as a comment.  
(G\COM)  
**G\SC:U;**

*Best practice for data source/link names and measurement names:*

- *Capitalized alphabetic characters*
- *Numeric characters*
- *Special character - use only underscore symbol*
- *No spaces between letters/numbers/symbol*

The XML snippet for the example above is shown in [Figure 3-1](#). [Figure 3-2](#) shows the relevant part of the XML schema in graphical form. [Table 3-1](#) shows the XML-to-TMATS code name mapping for this example. The codes [G\POC\N] and [G\DSI\N] do not apply because the number of points of contact and number of data sources can be inferred from the structure of the schema.

```

<TmatsG:ProgramName>TEST XYZ</TmatsG:ProgramName>
<TmatsG:TestItem>F16</TmatsG:TestItem>
<TmatsG:OriginationDate>2009-10-22</TmatsG:OriginationDate>
<TmatsG:Revision>
  <TmatsG:Number>106-13</TmatsG:Number>
</TmatsG:Revision>
<TmatsG:PointOfContact>
  <TmatsCommon:Name>Wile E. Coyote</TmatsCommon:Name>
  <TmatsCommon:Agency>ACME Corp</TmatsCommon:Agency>
  <TmatsCommon:Address>123 Roadrunner Way</TmatsCommon:Address>
  <TmatsCommon:Telephone>(555) 555-5555</TmatsCommon:Telephone>
</TmatsG:PointOfContact>
<TmatsG:DataSource Type="RF" Name="RF DATA SOURCE">
  <TmatsG:DataSourceSecurityClassification>
    Unclassified
  </TmatsG:DataSourceSecurityClassification>
</TmatsG:DataSource>
    
```

Figure 3-1. General Information Group Example XML

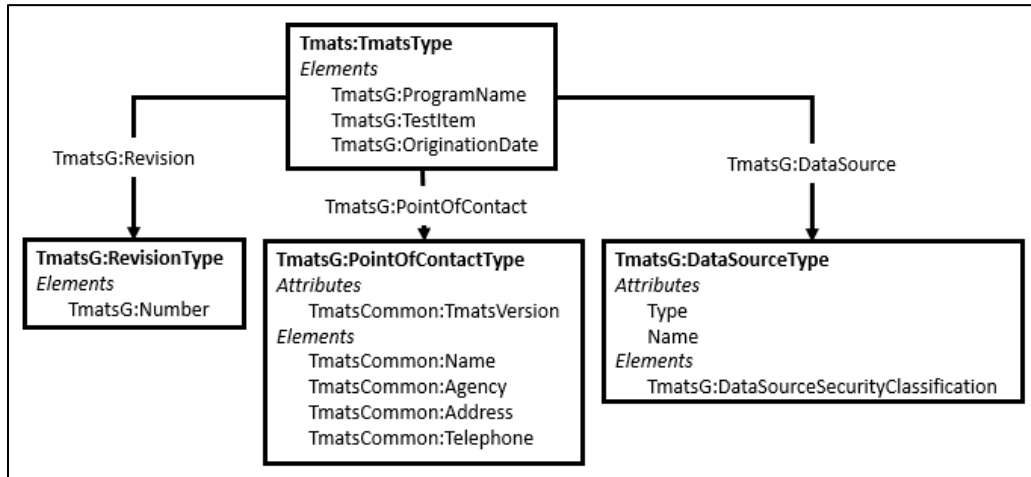

Figure 3-2. General Information Group Example XML Schema

Table 3-1. General Information Group XML Element-TMATS Code Name Pair	
XML Element Relative to Tmats:Tmats	Code Name
TmatsG:ProgramName	[G\PN]
TmatsG:TestItem	[G\TA]
TmatsG:Revision/TmatsG:Revision	[G\106]
TmatsG:OriginationDate	[G\OD]
N/A	[G\POC\N]
TmatsG:PointOfContact/TmatsCommon:Name	[G\POC1-n]
TmatsG:PointOfContact/TmatsCommon:Agency	[G\POC2-n]
TmatsG:PointOfContact/TmatsCommon:Address	[G\POC3-n]
TmatsG:PointOfContact/TmatsCommon:Telephone	[G\POC4-n]

N/A	[G\DSI\N]
TmatsG:DataSource/Name	[G\DSI-n]
TmatsG:DataSource/Type	[G\DST-n]
TmatsG:DataSource/TmatsG:DataSourceSecurityClassification	[G\SC]

### 3.2 The Transmission Attributes Group

The T-Group describes the transmission attributes by defining an RF link. For every RF link there is a corresponding T-Group.

- a. Data Source ID. A descriptive name for the data source. This is used to link the T-Group back to the data source ID from the G-Group and must match a G\DSI-n data item.

**T-1\ID:RF\_DATA\_SOURCE;**

- b. Frequency. The frequency in MHz that the transmitter operates at.

**T-1\RF1:2251.5;**

- c. Modulation Type. The type of modulation applied to the RF carrier defined here. This is a function of the type of transmitter selected. Other common types of modulation are phase modulation (PM) and the more complex multi-symbol (coded) shaped offset quadrature phase shift keying (SOQPSK-TG).

**T-1\RF4:FM;**

*Best practice for data source/link names and measurement names:*

- Capitalized alphabetic characters
- Numeric characters
- Special character - use only underscore symbol
- No spaces between letters/numbers/symbol

The XML snippet for the example above is shown in [Figure 3-3](#). [Figure 3-4](#) shows the relevant part of the XML schema in graphical form. [Table 3-2](#) shows the XML-to-TMATS code name mapping for this example. The code [T-n\ID] does not apply because the data source ID can be inferred from the structure of the schema.

```
<TmatsG:DataSource Type="RF" Name="RF DATA SOURCE">
  <TmatsG:TransmissionAttributes TmatsCommon:TmatsVersion="106-13">
    <TmatsT:SourceRFAttributes>
      <TmatsT:Frequency>2251.5</TmatsT:Frequency>
      <TmatsT:ModulationType>FM</TmatsT:ModulationType>
    </TmatsT:SourceRFAttributes>
  </TmatsG:TransmissionAttributes>
</TmatsG:DataSource>
```

Figure 3-3. Transmission Attributes Group Example XML

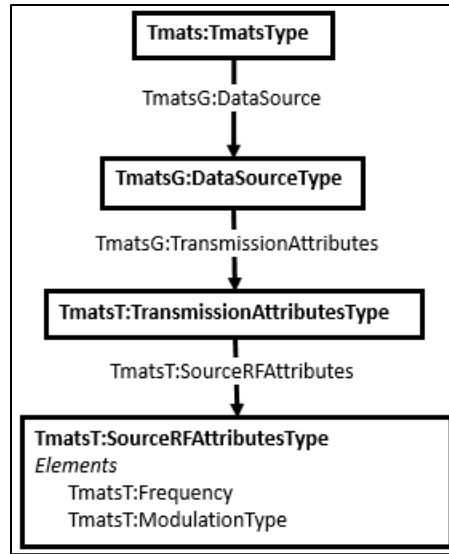

Figure 3-4. Transmission Attributes Group Example XML Schema

Table 3-2. Transmission Attributes Group XML Element-TMATS Code Name Pair	
XML Element Relative to Tmats:Tmats/ TmatsG:DataSource/ TmatsG:TransmissionAttributes/ TmatsT:SourceRFAttributes	Code Name
N/A	[T-n\ID]
TmatsT:Frequency	[T-n\RF1]
TmatsT:ModulationType	[T-n\RF4]

### 3.3 The Multiplex/Modulation Attributes Group

The M-Group describes the multiplex attributes. Every multiplexed waveform must have a unique set of attributes.

- a. Data Source ID. A descriptive name for the data source. This is used to link the M-Group back to the data source ID from a T-Group and must match the T-x\ID data item or from a Recorder-Reproducer Group (R-Group) and must match a R-x\ID data item.  
**M-1\ID:RF\_DATA\_SOURCE;**

- b. Baseband Signal Type. The baseband signal types are PCM, pulse amplitude modulation (PAM), Analog (ANA), Other (OTH), or None (NON). Today’s preferred TM format is PCM. The PAM format has been slowly phased out and is not widely used any more.  
**M-1\BSG1:PCM;**

*Best practice for data source/link names and measurement names:*

- Capitalized alphabetic characters
- Numeric characters
- Special character - use only underscore symbol
- No spaces between letters/numbers/symbol

- c. Data Link Name. The data link name for PCM and PAM formats used to link the M-Group to the data link name in a P-Group and must match a P-x\DLN data item.  
**M-1\BB\DLN:PCM\_STREAM;**

The XML snippet for the example above is shown in [Figure 3-5](#). [Figure 3-6](#) shows the relevant part of the XML schema in graphical form. [Table 3-3](#) shows the XML-to-TMATS code name mapping for this example.

```

<TmatsG:DataSource Type="RF" Name="RF DATA SOURCE">
  <TmatsG:MultiplexModulationGroup TmatsCommon:TmatsVersion="106-13">
    <TmatsM:BasebandSignal>
      <TmatsM:SignalType>PCM</TmatsM:SignalType>
      <TmatsM:DataLinkName>PCM_STREAM</TmatsM:DataLinkName>
    </TmatsM:BasebandSignal>
  </TmatsG:MultiplexModulationGroup>
</TmatsG:DataSource>

```

Figure 3-5. Multiplex/Modulation Attributes Group Example XML

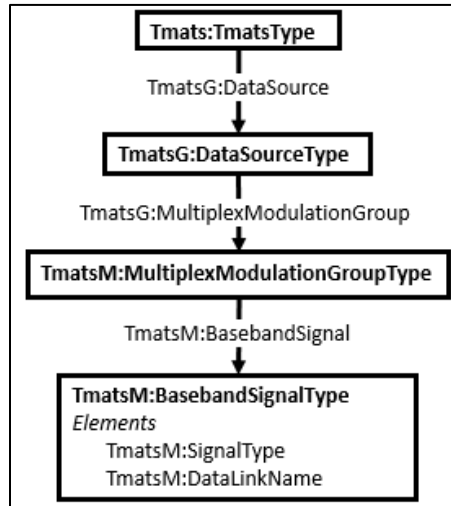

Figure 3-6. Multiplex/Modulation Attributes Group Example XML Schema

Table 3-3. Multiplex/Modulation Attributes Group XML Element-TMATS Code Name Pair	
XML Element Relative to Tmats:Tmats/ TmatsG:DataSource/ TmatsG:MultiplexModulationGroup/ TmatsM:BasebandSignal	Code Name
N/A	[M-1\ID]
TmatsM:SignalType	[M-1\BSG1]
TmatsM:DataLinkName	[M-1\BB\DLN]

### 3.4 The PCM Format Attributes Group

The P-Group describes information that is required to set up and decommutate a PCM data stream. It defines basic characteristics, like major frame, minor frame, and subframe information, as well as more complex features, such as embedded format descriptions. When working with PCM characteristics, RCC IRIG 106, Chapter 4 may be a helpful reference to further explain the various attributes used to describe a PCM format. [Figure 3-7](#) displays the attributes.

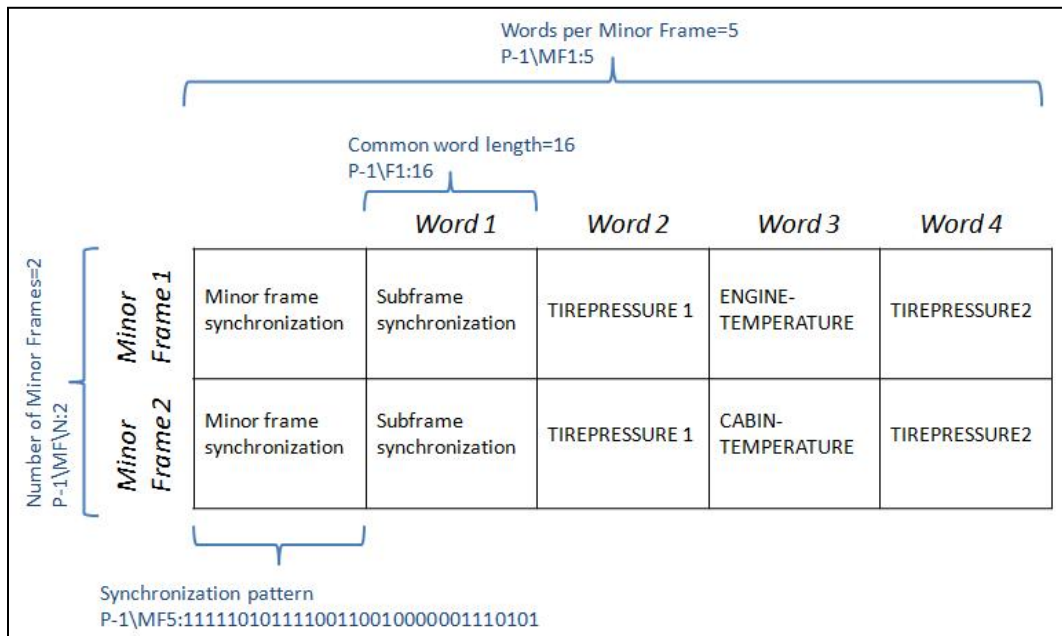

Figure 3-7. Attributes Used to Describe a PCM Format

- a. **Data Link Name.** The data link name is used to link the P-Group to the data link name in the M-Group and must match an M-x\BB\DLN or M-x\SI\DLN data item and D-Group and must match a D-x\DLN data item.  
**P-1\DLN:PCM\_STREAM;**

*Best practice for data source/link names and measurement names:*

- Capitalized alphabetic characters
- Numeric characters
- Special character - use only underscore symbol
- No spaces between letters/numbers/symbol

- b. PCM Code. The input data format for transmission, such as:

NRZ-L Non Return to Zero - Level  
NRZ-M Non Return to Zero - Mark  
NRZ-S Non Return to Zero - Space  
RNRZ-L Randomized Non Return to Zero - Level  
Bi $\phi$ -L Bi-Phase - Level  
Bi $\phi$ -M Bi-Phase - Mark  
Bi $\phi$ -S Bi-Phase -Space  
OTHER

**P-1\D1:NRZ-L;**

If “OTHER” is used, it should be defined in a comment.

**P-1\COM: “specify what other is”;**

*Best practice - avoid using  
“Other”*

- c. Bit Rate. The bit rate in bits per second (bps).

**P-1\D2:2000000;**

- d. Encrypted. The data stream is identified as encrypted (E) or unencrypted (U).

**P-1\D3:U;**

- e. Polarity. The data stream polarity is identified as normal (N) or inverted (I).

**P-1\D4:N;**

- f. Auto-Polarity Correction. Is automatic polarity correction being used? Yes (Y) or No (N).

**P-1\D5:Y;**

- g. Data Direction. The time sequence of the data stream is identified as normal (N) or reversed (R).

**P-1\D6:N;**

- h. Data Randomized. Is the data stream randomized? Yes (Y) or No (N).

**P-1\D7:N;**

- i. Randomizer Length. The randomized data length is specified as Standard (STD), Other (OTH), or Not Applicable (N/A). Standard length is 15 bits.

**P-1\D8:N/A;**

*Best practice - avoid using  
“Other”*

If “other” is used this should be defined in a comment.

**P-1\COM: “specify what other is”;**

The XML snippet for the example above is shown in [Figure 3-8](#). [Figure 3-9](#) shows the relevant part of the XML schema in graphical form. [Table 3-4](#) shows the XML-to-TMATS code name mapping for this example.



```

<TmatsG:PCMFormatAttributes TmatsCommon:TmatsVersion="106-13">
  <TmatsP:InputData>
    <TmatsP:PCMCode>NRZ-L</TmatsP:PCMCode>
    <TmatsP:BitRate>2000000</TmatsP:BitRate>
    <TmatsP:Encrypted>Unencrypted</TmatsP:Encrypted>
    <TmatsP:Polarity>Normal</TmatsP:Polarity>
    <TmatsP:AutoPolarityCorrection>Yes</TmatsP:AutoPolarityCorrection>
    <TmatsP:DataDirection>Normal</TmatsP:DataDirection>
    <TmatsP:DataRandomized>No</TmatsP:DataRandomized>
    <TmatsP:RandomizerLength>Not Applicable</TmatsP:RandomizerLength>
  </TmatsP:InputData>
</TmatsG:PCMFormatAttributes>
    
```

Figure 3-8. PCM Format Attributes Group Example XML

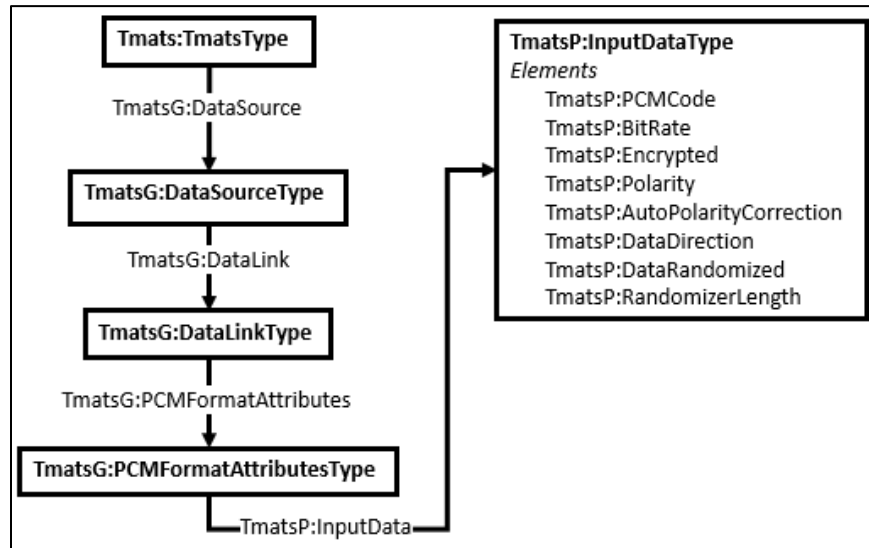

Figure 3-9. PCM Format Attributes Group Example XML Schema

<b>Table 3-4. PCM Format Attributes Group XML Element-TMATS Code Name Pair</b>	
<b>XML Element Relative to Tmats:Tmats/ TmatsG:DataSource/ TmatsG:DataLink/ TmatsG:PCMFormatAttributes/ TmatsP:InputData</b>	<b>Code Name</b>
TmatsP:PCMCode	[P-d\D1]
TmatsP:BitRate	[P-d\D2]
TmatsP:Encrypted	[P-d\D3]
TmatsP:Polarity	[P-d\D4]
TmatsP:AutoPolarityCorrection	[P-d\D5]
TmatsP:DataDirection	[P-d\D6]
TmatsP:DataRandomized	[P-d\D7]
TmatsP:RandomizerLength	[P-d\D8]

- j. Type Format. The type of PCM formatting – Class I (ONE), Class II (TWO), 1553 Bus (1553), Bus (BUS), Alternate Tag and Data (ALTD), or Other (OTHR). The different class distinctions are identified in the RCC IRIG 106, Chapter 4 standard.

**P-1\TF:ONE;**

If “other” is used this should be defined in a comment.

*Best practice - avoid using “Other”*

**P-1\COM: “specify what other is”;**

- k. Common Word Length. The common word length in bits. The word length can be as little as 4, but not more than 64.

**P-1\F1:16;**

- l. Word Transfer Order. The default for which bit is being transferred first in a normal time sequence – msb (M) or lsb (L).

**P-1\F2:M;**

- m. Parity. The normal word parity is specified as even (EV), odd (OD), or none (NO).

**P-1\F3:NO;**

- n. Number of Minor Frames. The number of minor frames in the major frame.

**P-1\MF\N:2;**

 <b>NOTE</b>	<b>As stated in RCC IRIG 106, Chapter 4:</b> “To provide consistent notation, the first minor frame in a major frame shall be numbered one. Each subsequent minor frame shall be numbered sequentially within the major frame.”
--	--

- o. Number of Words in a Minor Frame. The number of words in each minor frame. The frame synchronization pattern is always considered to be one word, regardless of its length (as stated in RCC IRIG 106, Chapter 4). In this case, the common word length is 16 bits and the frame sync pattern is 32 bits, but the sync pattern is counted as one word, not two words.

**P-1\MF1:5;**

 <p><b>NOTE</b></p>	<p><b>As stated in RCC IRIG 106, Chapter 4:</b>          “To provide consistent notation, the first word after the minor frame synchronization pattern shall be numbered one. Each subsequent word shall be numbered sequentially within the minor frame.”</p>
--	--

- p. Sync Type. The minor frame synchronization type is specified as either fixed pattern (FPT) or Other (OTH).

**P-1\MF3:FPT;**

If “fixed pattern” is used, the frame synchronization pattern is described in the attributes MF4 and MF5, which follow.

If “other” is used this should be defined in a comment.

*Best practice - avoid using “Other”*

**P-1\COM: “specify what other is”;**

- q. Synchronization Pattern Length. The number of bits in the minor frame synchronization pattern.

**P-1\MF4:32;**

- r. Synchronization Pattern. The minor frame synchronization pattern, in binary.

1111	1010	1111	0011	0010	0000	0111	0101
F	A	F	3	2	0	7	5

**P-1\MF5:11111010111100110010000001110101;**

The XML snippet for the example above is shown in [Figure 3-10](#). [Figure 3-11](#) shows the relevant part of the XML schema in graphical form. [Table 3-5](#) shows the XML-to-TMATS code name mapping for this example. The code [P-d\MF4] does not apply because the synchronization pattern length can be inferred from the value of the code [P-d\MF5].

```

<TmatsG:PCMFormatAttributes TmatsCommon:TmatsVersion="106-13">
  <TmatsP:Format>
    <TmatsP:TypeFormat>Class 1</TmatsP:TypeFormat>
    <TmatsP:CommonWordLength>16</TmatsP:CommonWordLength>
    <TmatsP:WordTransferOrder>MSB First</TmatsP:WordTransferOrder>
    <TmatsP:Parity>None</TmatsP:Parity>
    <TmatsP:MinorFrame>
      <TmatsP:NumberOfMinorFrames>2</TmatsP:NumberOfMinorFrames>
      <TmatsP:WordsPerMinorFrame>5</TmatsP:WordsPerMinorFrame>
      <TmatsP:BitsPerMinorFrame>96</TmatsP:BitsPerMinorFrame>
      <TmatsP:SyncType>Fixed Pattern</TmatsP:SyncType>
      <TmatsP:SyncPattern>
        11111010111100110010000001110101
      </TmatsP:SyncPattern>
    </TmatsP:MinorFrame>
  </TmatsP:Format>
</TmatsG:PCMFormatAttributes>
```

Figure 3-10. PCM Format Attributes Group Example XML

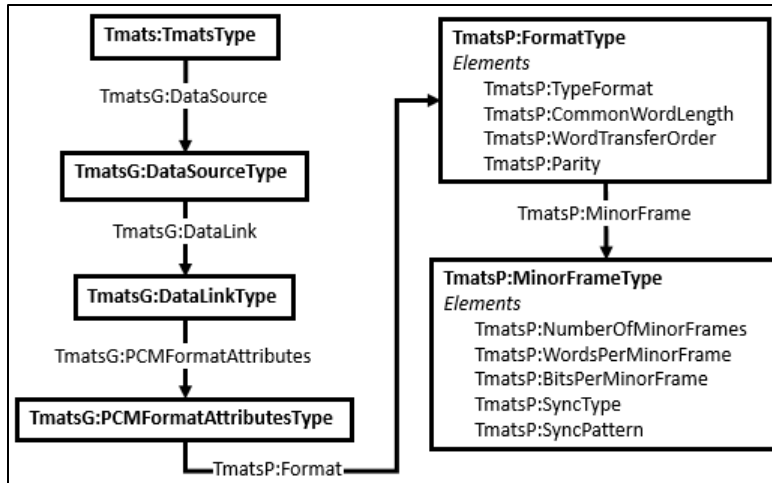

Figure 3-11. PCM Format Attributes Group Example XML Schema

Table 3-5. PCM Format Attributes Group XML Element-TMATS Code Name Pair	
XML Element Relative to Tmats:Tmats/ TmatsG:DataSource/ TmatsG:DataLink/ TmatsG:PCMFormatAttributes/ TmatsP:Format	Code Name
TmatsP:TypeFormat	[P-d\TF]
TmatsP:CommonWordLength	[P-d\F1]
TmatsP:WordTransferOrder	[P-d\F2]
TmatsP:Parity	[P-d\F3]
TmatsP:MinorFrame/TmatsP:NumberOfMinorFrames	[P-d\MF\N]
TmatsP:MinorFrame/TmatsP:WordsPerMinorFrame	[P-d\MF1]
TmatsP:MinorFrame/TmatsP:BitsPerMinorFrame	[P-d\MF2]
TmatsP:MinorFrame/TmatsP:SyncType	[P-d\MF3]
N/A	[P-d\MF4]
TmatsP:MinorFrame/TmatsP:SyncPattern	[P-d\MF5]

- s. In Sync Criteria. The “in sync” criteria are described by specifying the desired states to declare that the system is in sync – First good sync (0), Check (1 or greater), or Not specified (NS).

**P-1\SYNC1:NS;**

- t. Sync Pattern Criteria. The “in sync” criteria are further described by specifying the number of bits that may be in error within the sync pattern. This is the maximum number of bits in the sync pattern that may be in error while not in lock before transitioning to lock.

**P-1\SYNC2:0;**

- u. Out of Sync Pattern Criteria. The “out of sync” criteria are described by specifying the number of bits that may be in error within the sync pattern. This is the maximum number of bits in the sync pattern that may be in error while in lock before transitioning out of lock.

**P-1\SYNC4:0;**

- v. Number of Subframe ID Counters. The number of subframe ID counters that are defined in the minor frame. Normally in PCM formats only one subframe ID is defined.

**P-1\ISF\N:1;**

- w. Subframe ID Counter Name. The name of the subframe ID counter. This is not for use as a measurement name; it is used for identification in cases where there are multiple subframe ID counters.

**P-1\ISF1-1:SFID;**

- x. Subframe Sync Type. The subframe synchronization type - ID counter (ID) or Other (OT).

**P-1\ISF2-1:ID;**

If “ID counter” is used, the ID counter is described in detail in the attributes IDC1 through IDC10, which follow.

If “other” is used this should be defined in a comment.

**P-1\COM: “specify what other is”;**

*Best practice - avoid using “Other”*

- y. Subframe ID Counter Location. The minor frame word position of the counter, when ID counter is designated as the subframe sync type.

**P-1\IDC1-1:1;**

- z. ID Counter msb Starting Bit Location. The starting msb bit location of the ID counter within the whole word. This is not the msb of the word but the msb position of the bits that are actually used for the counter. In this case, only one bit is needed to count two minor frames. Assuming that the ID counter is right-justified within the word, the rightmost bit (by convention, bit 16) would be used.

**P-1\IDC3-1:16;**

*Common Mistake: The bit location (IDC3) and length (IDC4) of the subframe ID counter are defined as if the entire word was being used as the counter, indicated by a bit location of 1 and counter length equal to the word length.*

- aa. ID Counter Length. The subframe ID counter length in number of bits. This is not the word size but only the number of bits in the word that are actually used for the counter. In this case, only one bit is needed to count two minor frames.

**P-1\IDC4-1:1;**

*BEST PRACTICE: Use the bit location and counter length to indicate only the bits being used as the counter.*

- bb. ID Counter Transfer Order. Which bit is being transferred first is specified as msb (M), lsb (L), or Default (D). The default will be as specified in word transfer order (P-1\F2).

**P-1\IDC5-1:D;**

- cc. ID Counter Initial Value. The initial value of the ID counter.

**P-1\IDC6-1:0;**

dd. Initial Count Subframe Number. The minor frame number associated with the initial count value. **Note:** Must always be 1 (1 to n), as described in RCC IRIG 106, Chapter 4.

**P-1\IDC7-1:1;**

ee. ID Counter End Value. The end value of the ID counter.

**P-1\IDC8-1:1;**

ff. End Count Subframe Number. The minor frame number associated with the end count value.

**P-1\IDC9-1:2;**

gg. Count Direction. The direction of the count increment – Increasing (INC) or Decreasing (DEC). Preferred usage is INC.

**P-1\IDC10-1:INC;**

The XML snippet for the example above is shown in [Figure 3-12](#). [Figure 3-13](#) shows the relevant part of the XML schema in graphical form. [Table 3-6](#) shows the XML-to-TMATS code name mapping for this example.

```
<TmatsG:PCMFormatAttributes TmatsCommon:TmatsVersion="106-13">
  <TmatsP:SyncCriteria>
    <TmatsP:InSync>
      <TmatsP:Criteria>Not Specified</TmatsP:Criteria>
      <TmatsP:NumberOfFSPBits>0</TmatsP:NumberOfFSPBits>
    </TmatsP:InSync>
    <TmatsP:OutOfSync>
      <TmatsP:NumberOfDisagrees>Not Specified</TmatsP:NumberOfDisagrees>
    </TmatsP:OutOfSync>
  </TmatsP:SyncCriteria>
  <TmatsP:SubframeSynchronization>
    <TmatsP:IDCounter>
      <TmatsP:Name>SFID</TmatsP:Name>
      <TmatsP:SyncType>ID Counter</TmatsP:SyncType>
      <TmatsP:Location>1</TmatsP:Location>
      <TmatsP:CounterStartingBitLocation>16</TmatsP:CounterStartingBitLocation>
      <TmatsP:CounterLength>1</TmatsP:CounterLength>
      <TmatsP:TransferOrder>Default</TmatsP:TransferOrder>
      <TmatsP:InitialValue>0</TmatsP:InitialValue>
      <TmatsP:InitialMinorFrameNumber>1</TmatsP:InitialMinorFrameNumber>
      <TmatsP:EndValue>1</TmatsP:EndValue>
      <TmatsP:EndMinorFrameNumber>2</TmatsP:EndMinorFrameNumber>
      <TmatsP:CountDirection>Increasing</TmatsP:CountDirection>
    </TmatsP:IDCounter>
  </TmatsP:SubframeSynchronization>
</TmatsG:PCMFormatAttributes>
```

Figure 3-12. PCM Format Attributes Group Example XML

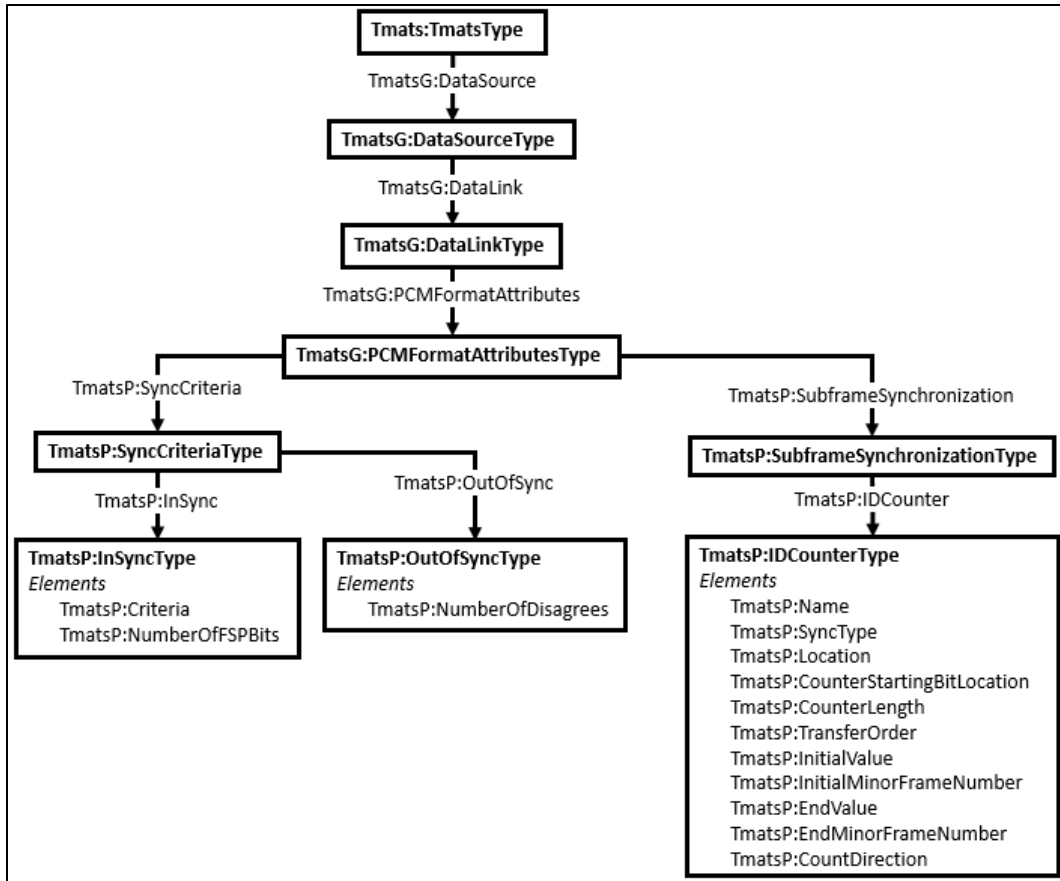

Figure 3-13. PCM Format Attributes Group Example XML Schema

<b>Table 3-6. PCM Format Attributes Group XML Element-TMATS Code Name Pair</b>	
<b>XML Element Relative to Tmats:Tmats/ TmatsG:DataSource/ TmatsG:DataLink/ TmatsG:PCMFormatAttributes/ TmatsP:SyncCriteria</b>	<b>Code Name</b>
TmatsP:InSync/TmatsP:Criteria	[P-d\SYNC1]
TmatsP:InSync/TmatsP:NumberOfFSPBits	[P-d\SYNC2]
TmatsP:OutOfSync/TmatsP:NumberOfDisagrees	[P-d\SYNC4]
<b>XML Element Relative to Tmats:Tmats/ TmatsG:DataSource/ TmatsG:DataLink/ TmatsG:PCMFormatAttributes/ TmatsP:SubframeSynchronization</b>	
TmatsP:IDCounter/TmatsP:Name	[P-d\ISF1-n]
TmatsP:IDCounter/TmatsP:SyncType	[P-d\ISF2-n]

TmatsP:IDCounter/TmatsP:Location	[P-d\IDC1-n]
TmatsP:IDCounter/TmatsP:CounterStartingBitLocation	[P-d\IDC3-n]
TmatsP:IDCounter/TmatsP:CounterLength	[P-d\IDC4-n]
TmatsP:IDCounter/TmatsP:TransferOrder	[P-d\IDC5-n]
TmatsP:IDCounter/TmatsP:InitialValue	[P-d\IDC6-n]
TmatsP:IDCounter/TmatsP:InitialMinorFrameNumber	[P-d\IDC7-n]
TmatsP:IDCounter/TmatsP:EndValue	[P-d\IDC8-n]
TmatsP:IDCounter/TmatsP:EndMinorFrameNumber	[P-d\IDC9-n]
TmatsP:IDCounter/TmatsP:CountDirection	[P-d\IDC10-n]

### 3.5 The PCM Measurement Description Group

The D-Group describes each measurement within the major frame by specifying measurement name, location, and number of bits. Referring back to our example, the parameters of interest are Tire Pressure 1, Tire Pressure 2, Engine Temperature, and Cabin Temperature.

[Figure 3-14](#) displays the parameter layout.

		Word 1	Word 2	Word 3	Word 4	
Minor Frame	Frame 1	Minor frame synchronization	Subframe synchronization	TIREPRESSURE 1	ENGINE-TEMPERATURE	TIREPRESSURE2
	Frame 2	Minor frame synchronization	Subframe synchronization	TIREPRESSURE 1	CABIN-TEMPERATURE	TIREPRESSURE2

Figure 3-14. Measurements Within the Major Frame

- a. Data Link Name. The data link name is used to link the D-Group back to the data link name in the P-Group and must match a P-d\DLN data item.

**D-1\DLN:PCM\_STREAM;**

- b. Number of Measurement Lists. The number of measurement lists to be provided from the measurements in the data stream.

**D-1\ML\N:1;**

- c. Measurement List Name. The measurement list name that will be associated with the following attributes in the D-Group. In this example we only have one measurement list to describe.

**D-1\MLN-1:Measurement List;**

If you are defining more than one measurement list, the information that follows below will have to be repeated for each measurement list that is identified in the P-Group.

*Best practice for data source/link names and measurement names:*

- Capitalized alphabetic characters
- Numeric characters
- Special character - use only underscore symbol
- No spaces between letters/numbers/symbol



- d. Number of Measurements. The number of measurements in this measurement list. This example includes the four parameters of interest - Tire Pressure 1, Tire Pressure 2, Engine Temperature, and Cabin Temperature.

**D-1\MN\N-1:4;**

- e. Measurement Name. The measurement name not only provides the name of the measurement but is used to link to the measurement's conversion in the Data Conversion Attributes Group (C-Group).

**D-1\MN-1-1:TIREPRESSURE1;**

Subsequently, measurement 2 would be described as:

**D-1\MN-1-2:ENGINETEMPERATURE;**

*Best practice for data source/link names and measurement names:*

- Capitalized alphabetic characters
- Numeric characters
- Special character - use only underscore symbol
- No spaces between letters/numbers/symbol

- f. Parity. Parity is specified as Even (EV), Odd (OD), None (NO), or Minor Frame Default (DE). If default is used then it will be specified in the P-Group - (P-1\F3:NO).

**D-1\MN1-1-1:DE;**

- g. Measurement Transfer Order. Which bit is being transferred first is specified as msb (M), lsb (L), or Default (D). The default is specified in the P-Group - (P-1\F2:M).

**D-1\MN3-1-1:M;**

- h. Measurement Location Type. The method used to locate the measurement within the major frame. Word and frame (represented by the TMATS enumeration WDFR) is the preferred location type since it can describe any variation of a measurement location, whether the measurements are in equal intervals, uneven intervals, supercommutated, or fragmented.

**D-1\LT-1-1:WDFR;**

Attributes associated with WDFR are described in further detail below.

*Best Practice:*

- The preferred method to describe the measurement location is to use the word and frame specifications.
- When using word and frame, it is highly recommended to avoid the use of the other location types in the same TMATS file.
- When using word and frame, it is recommended to avoid the use of subframes as defined in the Subframe Definitions section of the P-Group.
- As of RCC IRIG 106-11, the other location types and subframes have been removed from Chapter 9.

- i. Number of Measurement Locations.

The number of locations to follow for the measurement.

**D-1\MML\N-1-1:1;**

- j. Number of Fragments. The number of fragments the measurement occupies. If the measurement is not fragmented, as in this case, enter 1.

**D-1\MNF\N-1-1-1:1;**

[Figure 3-15](#) displays the attributes associated with WDFR – Word Position (WP), Frame Position (FP), and Frame Interval (FI)

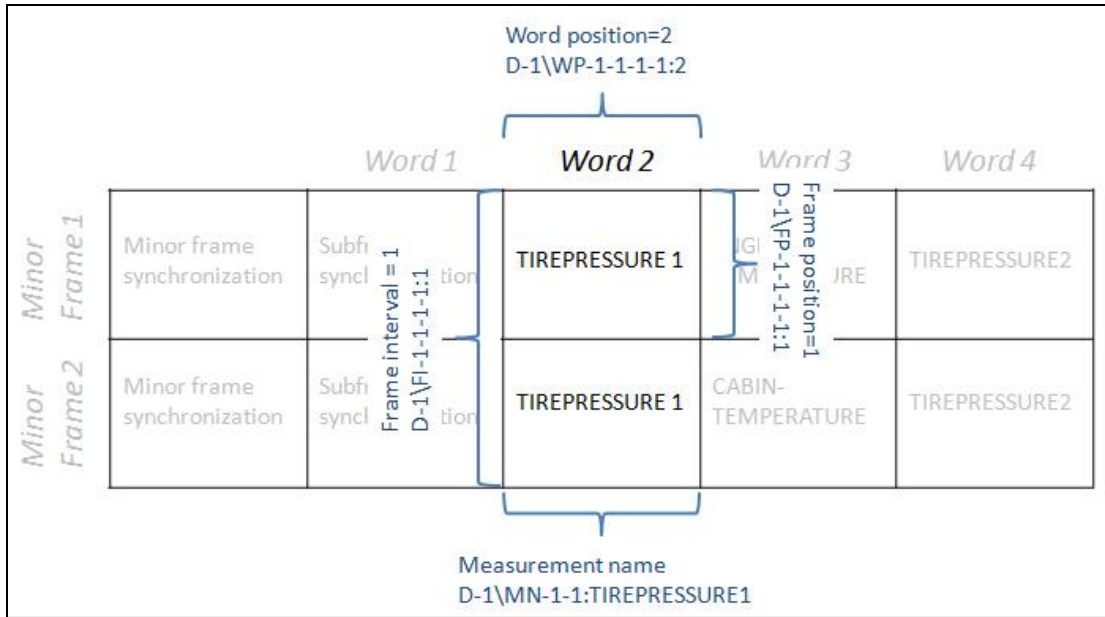

Figure 3-15. Attributes Associated with Word and Frame

- k. Word Position. The word position location(s) of the minor frame word for the measurement. In this case, TIREPRESSURE1 is in word 2 in minor frame 1 and minor frame 2.

**D-1\WP-1-1-1-1:2;**

- l. Word Interval. The offset from the first word location to the second and all subsequent word locations. An interval of “0” indicates there is only one word location for this measurement.

**D-1\WI-1-1-1-1:0;**

- m. Frame Position. The frame position location of the minor frame for the measurement. In this case, TIREPRESSURE1 starts in minor frame 1 and is also in minor frame 2. In this case the frame locations are equally incremented, so the initial frame position of “1” is used.

**D-1\FP-1-1-1-1:1;**

- n. Frame Interval. The offset from the first frame location to the second and all subsequent frame locations. An interval of “0” indicates there is only one frame location for this measurement. In this case, TIREPRESSURE 1 starts in minor frame 1 and is also in minor frame 2. The initial frame position of “1” was used above, therefore for this case the offset (interval) is 1 to describe the frame 2 position.

**D-1\FI-1-1-1-1:1;**

- o. Bit Mask. The bit positions to be used by the measurement. If using all bits of the word, designate “FW” for full word. Remember the leftmost bit corresponds to the msb.

*Common Mistake: The total number of minor frames per major frame is entered to indicate there is only one frame location instead of using “0”. Example: If there are 16 minor frames per major frame, “16” is used instead of “0”.*

*BEST PRACTICE: Use “0” to indicate there is only one frame location.*

**D-1\WFM-1-1-1-1:FW;**

The XML snippet for the example above is shown in [Figure 3-16](#). [Figure 2-15](#) shows the relevant part of the XML schema in graphical form. [Table 3-7](#) shows the XML-to-TMATS code name mapping for this example. The codes [D-x\ML\N], [D-x\MN\N-n], [D-x\MML\N-y-n], and [D-x\MNF\N-y-n-m] do not apply because the number of measurement lists, the number of measurements, the number of measurement location, and the number of measurement fragments can be inferred from the structure of the schema.

```

<TmatsG:DataLink Name="PCM STREAM">
  <TmatsG:PCMFormatAttributes TmatsCommon:TmatsVersion="106-13">
    <TmatsP:PCMMeasurements TmatsCommon:TmatsVersion="106-13">
      <TmatsD:MeasurementList Name="TIREFPRESSURE1">
        <TmatsD:Measurement Name="TIREFPRESSURE1">
          <TmatsD:Parity>Default</TmatsD:Parity>
          <TmatsD:MeasurementTransferOrder>
            MSB First
          </TmatsD:MeasurementTransferOrder>
          <TmatsD:LocationType>Word and Frame</TmatsD:LocationType>
          <TmatsD:WordAndFrame>
            <TmatsD:MeasurementLocation>
              <TmatsD:MeasurementFragments>
                <TmatsD:StartWord>2</TmatsD:StartWord>
                <TmatsD:WordInterval>0</TmatsD:WordInterval>
                <TmatsD:StartFrame>1</TmatsD:StartFrame>
                <TmatsD:FrameInterval>0</TmatsD:FrameInterval>
                <TmatsD:BitMask>Full Word</TmatsD:BitMask>
              </TmatsD:MeasurementFragments>
            </TmatsD:MeasurementLocation>
          </TmatsD:WordAndFrame>
        </TmatsD:Measurement>
      </TmatsD:MeasurementList>
    </TmatsP:PCMMeasurements>
  </TmatsG:PCMFormatAttributes>
</TmatsG:DataLink>

```

Figure 3-16. PCM Measurement Description Group Example XML

<b>Table 3-7. PCM Measurement Description Group XML Element-TMATS Code Name Pair</b>	
<b>XML Element Relative to Tmats:Tmats</b>	<b>Code Name</b>
TmatsG:DataLink/Name	[D-x\DLN]
N/A	[D-x\ML\N]
<b>XML Element Relative to Tmats:Tmats/ TmatsG:TmatsG:DataLink/ TmatsG:PCMFormatAttributes/ TmatsG:PCMMeasurements</b>	
TmatsD:MeasurementList/Name	[D-x\MLN-n]

N/A	[D-x\MN\N-n]
<b>XML Element Relative to Tmats:Tmats/ TmatsG:TmatsG:DataLink/ TmatsG:PCMFormatAttributes/ TmatsG:PCMMeasurements/ TmatsD:MeasurementList/ TmatsD:Measurement</b>	
Name	[D-x\MN-n-x]
TmatsD:Parity	[D-x\MN1-n-x]
TmatsD:MeasurementTransferOrder	[D-x\MN3-n-x]
TmatsD:LocationType	[D-x\LT-y-n]
N/A	[D-x\MML\N-y-n]
N/A	[D-x\MNF\N-y-n-m]
<b>XML Element Relative to Tmats:Tmats/ TmatsG:TmatsG:DataLink/ TmatsG:PCMFormatAttributes/ TmatsG:PCMMeasurements/ TmatsD:MeasurementList/ TmatsD:Measurement/ TmatsD:WordAndFrame/ TmatsD:MeasurementLocation/ TmatsD:MeasurementFragments</b>	
TmatsD:StartWord	[D-x\WP-y-n-m-e]
TmatsD:WordInterval	[D-x\WI-y-n-m-e]
TmatsD:StartFrame	[D-x\FP-y-n-m-e]
TmatsD:FrameInterval	[D-x\FI-y-n-m-e]
TmatsD:BitMask	[D-x\WFM-y-n-m-e]

### 3.6 The Data Conversion Attributes Group

The C-Group defines the data conversion attributes of a measurement. This group includes a definition of how to take the raw TM bits and convert them to EUs. This group describes the various conversion methods.

- a. Measurement Name. The measurement name is used to link the C-Group back to the measurement name in the D-Group and must match a D-x\MN-y-n data item.

**C-1\DCN:TIREPRESSURE1;**

- b. Description. A short narrative to describe the measurement. This is a text field, not a measurement name.

**C-1\MN1:Tire Pressure 1 - Left;**

*Best practice for data source/link names and measurement names:*

- Capitalized alphabetic characters
- Numeric characters
- Special character - use only underscore symbol
- No spaces between letters/numbers/symbol

- c. Binary Format. The binary format of the measurement in the PCM stream (i.e., the input format). Specify either – Integer (INT), Unsigned Binary (UNS), Sign and Magnitude Binary +=0 (SIG), Sign and Magnitude Binary +=1 (SIM), One’s Complement (ONE), Two’s Complement (TWO), Offset Binary (OFF), Floating Point (FPT), Binary Coded Decimal (BCD), Bit Weight (BWT), and Other (OTH). In this case, the binary format of the measurement is Two’s Complement.

**C-1\BFM:TWO;**

If “other” is used this should be specified in a comment.

**C-1\COM: “specify what other is”;**

*Best practice - avoid using “Other”*

- d. Data Conversion Type. The conversion type that yields the output of the measurement. If there is no data conversion, specify None (NON). For EU conversion, enter – Pair Sets (PRS), Coefficients (COE), Coefficients – negative powers of x (NPC), Derived (DER), Discrete (DIS), PCM Time (PTM), 1553 Time (BTM), Digital Voice (VOI), Digital Video (VID), Special Processing (SP), or Other (OTH). In this case, we are using coefficients and the slope and intercept will be described in the following attributes.

**C-1\DCT:COE;**

If “other” is used this should be specified in a comment.

**C-1\COM: “specify what other is”**

*Best practice - avoid using “Other”*

- e. Order of Curve Fit. The order of the polynomial curve fit.

**C-1\CO\N:1;**

- f. Coefficient (0). The value of the zero-order coefficient (Offset/intercept).

**C-1\CO:-5.12;**

- g. N-th Coefficient. The value of the coefficient of the Nth power of X. In the case of the 1st order fit, specify the gain/slope.

**C-1\CO-1:.0025;**

The XML snippet for the example above is shown in [Figure 3-17](#). [Figure 3-18](#) shows the relevant part of the XML schema in graphical form. [Table 3-8](#) shows the XML-to-TMATS code name mapping for this example. The code [C-d\CO\N] does not apply because the order of the curve fit can be inferred from the TmatsC:Coefficient element.

```

<TmatsG:DataConversionAttributes TmatsCommon:TmatsVersion="106-13">
  <TmatsC:Measurement Name="TIREPRESSURE1">
    <TmatsC:Measurand>
      <TmatsC:Description>Tire Pressure 1 - Left</TmatsC:Description>
    </TmatsC:Measurand>
    <TmatsC:TelemetryValueDefinition>
      <TmatsC:BinaryFormat>Two's Complement</TmatsC:BinaryFormat>
    </TmatsC:TelemetryValueDefinition>
    <TmatsC:DataConversion Type="Coefficients">
      <TmatsC:Coefficients>
        <TmatsC:Coefficient N="0">-5.12</TmatsC:Coefficient>
        <TmatsC:Coefficient N="1">0.0025</TmatsC:Coefficient>
      </TmatsC:Coefficients>
    </TmatsC:DataConversion>
  </TmatsC:Measurement>
</TmatsG:DataConversionAttributes>
    
```

Figure 3-17. Data Conversion Attributes Group Example XML

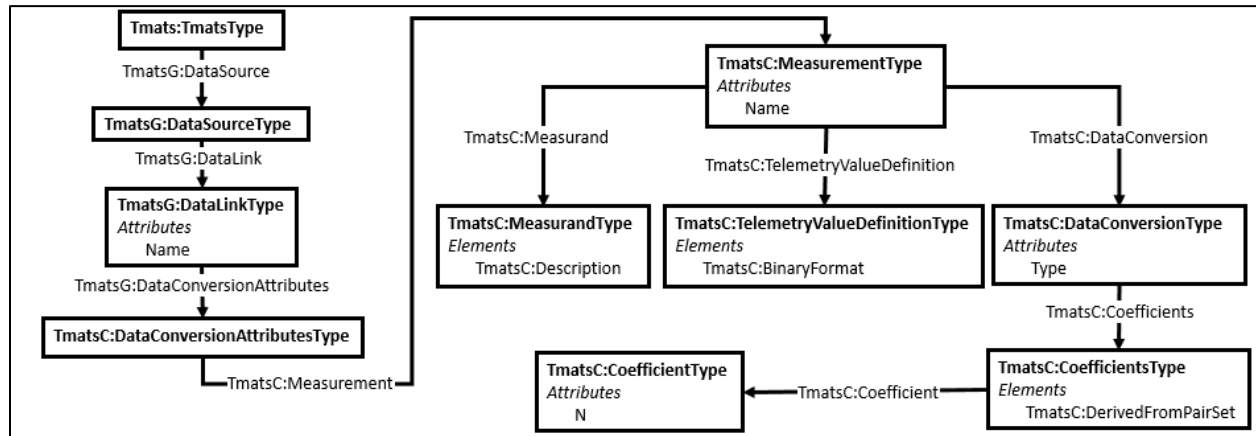

Figure 3-18. Data Conversion Attributes Group Example XML Schema

Table 3-8. Data Conversion Attributes Group XML Element-TMATS Code Name Pair	
XML Element Relative to Tmats:Tmats/ TmatsG:DataSource/ TmatsG:DataLink/ TmatsC:Measurement	Code Name
Name	[C-d\DCN]
TmatsC:Measurand/TmatsC:Description	[C-d\MN1]
TmatsC:TelemetryValueDefinition/TmatsC:BinaryFormat	[C-d\BFM]
TmatsC:DataConversion/Type	[C-d\DCT]
N/A	[C-d\CO\N]
TmatsC:DataConversion/TmatsC:Coefficients/TmatsC:Coefficient	[C-d\CO]
TmatsC:DataConversion/TmatsC:Coefficients/TmatsC:Coefficient/N	[C-d\CO-n]

### 3.7 The Completed TMATS File

Figure 3-19 displays a complete TMATS file.

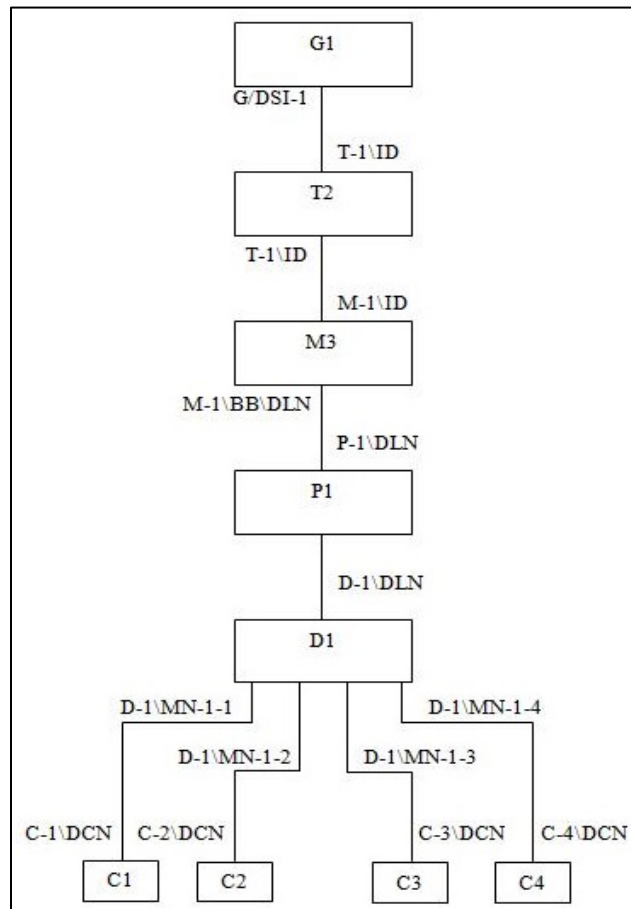

Figure 3-19. The Completed TMATS File

COMMENT: \* G-Group – General Information \*;

```
G\PN:TEST_XYZ;
G\TA:F16;
G\106:09;
G\OD:10-22-2009;
COMMENT: Contact information
G\POC\N:1;
G\POC1-1:Wile E. Coyote;
G\POC2-1:ACME Corp;
G\POC3-1:123 Road Runner Way Phoenix AZ 99999;
G\POC4-1:(555)555-5555;
G\DSI\N:1;
G\DSI-1:RF_DATA_SOURCE;
G\DST-1:RF;
G\SC:U;
```

*Data Source ID is unique within a G-Group and it ties to the T-Group and the M-Group – RF\_Data\_Source.*

COMMENT: \* T-Group – Transmission Attributes\*;

T-1\ID:RF\_DATA\_SOURCE;

T-1\RF1:2251.5;

T-1\RF4:FM;

COMMENT: \* M-Group - Multiplex/Modulation\*;

M-1\ID:RF\_DATA\_SOURCE;

M-1\BSG1:PCM;

M-1\BB\DLN:PCM\_STREAM;

M-1\SI\N:0;

COMMENT: \* P-Group - PCM Format Information\*;

P-1\DLN:PCM\_STREAM;

P-1\D1:NRZ-L;

P-1\D2:2000000;

P-1\D3:U;

P-1\D4:N;

P-1\D5:Y;

P-1\D6:N;

P-1\D7:N;

P-1\D8:N/A;

P-1\TF:ONE;

P-1\F1:16;

P-1\F2:M;

P-1\F3:NO;

P-1\MF\N:2;

P-1\MF1:5;

P-1\MF3:FPT;

P-1\MF4:32;

COMMENT: Frame Sync Pattern of FAF32075, defined in binary bits;

P-1\MF5:11111010111100110010000001110101;

P-1\SYNC1:NS;

P-1\SYNC2:0;

P-1\SYNC4:0;

P-1\ISF\N:1;

P-1\ISF1-1:SFID;

P-1\ISF2-1:ID;

P-1\IDC1-1:1;

P-1\IDC3-1:16;

P-1\IDC4-1:1;

P-1\IDC5-1:D;

P-1\IDC6-1:0;

P-1\IDC7-1:1;

P-1\IDC8-1:1;

P-1\IDC9-1:2;

P-1\IDC10-1:INC;

COMMENT: \* D-Group–PCM Measurement Descriptions \*;

D-1\DLN:PCM\_STREAM;

*The tie from the M-Group  
to a P-Group is the Data  
Link Name –  
PCM\_Stream*

*The tie from the P-  
Group to the D-Group is  
the Data Link Name –  
PCM\_Stream*



D-1\ML\N:1;  
D-1\MLN-1:Measurement List;  
D-1\MN\N-1:4;  
COMMENT : PCM location and number of bits in the word for TIREPRESSURE1;  
**D-1\MN-1-1:TIREPRESSURE1;**  
D-1\MN1-1-1:DE;  
D-1\MN2-1-1:D;  
D-1\MN3-1-1:M;  
D-1\LT-1-1:WDFR;  
D-1\MML\N-1-1:1;  
D-1\MNF\N-1-1-1:1;  
D-1\WP-1-1-1-1:2;  
D-1\WI-1-1-1-1:0;  
D-1\FP-1-1-1-1:1;  
D-1\FI-1-1-1-1:1;  
D-1\WFM-1-1-1-1:FW;  
COMMENT : PCM location and number of bits in the word for  
ENGINETEMPERATURE;  
D-1\MN-1-2:ENGINETEMPERATURE;  
D-1\MN1-1-2:DE;  
D-1\MN2-1-2:D;  
D-1\MN3-1-2:M;  
D-1\LT-1-2:WDFR;  
D-1\MML\N-1-2:1;  
D-1\MNF\N-1-2-1:1;  
D-1\WP-1-2-1-1:3;  
D-1\WI-1-2-1-1:0;  
D-1\FP-1-2-1-1:1;  
D-1\FI-1-2-1-1:0;  
D-1\WFM-1-2-1-1:FW;  
COMMENT : PCM location and number of bit in the word for TIREPRESSURE2;  
D-1\MN-1-3:TIREPRESSURE2;  
D-1\MN1-1-3:DE;  
D-1\MN2-1-3:D;  
D-1\MN3-1-3:M;  
D-1\LT-1-3:WDFR;  
D-1\MML\N-1-3:1;  
D-1\MNF\N-1-3-1:1;  
D-1\WP-1-3-1-1:4;  
D-1\WI-1-3-1-1:0;  
D-1\FP-1-3-1-1:1;  
D-1\FI-1-3-1-1:1;  
D-1\WFM-1-3-1-1:FW;  
COMMENT : PCM location and number of bit in the word for  
CABINTEMPERATURE;  
D-1\MN-1-4:CABINTEMPERATURE;

*The tie from the D-Group to the C-Group is the Measurement Name – MN to DCN - TIREPRESSURE1*

D-1\MN2-1-4:D;  
D-1\MN3-1-4:M;  
D-1\LT-1-4:WDFR;  
D-1\MML\N-1-4:1;  
D-1\MNF\N-1-4-1:1;  
D-1\WP-1-4-1-1:3;  
D-1\WI-1-4-1-1:0;  
D-1\FP-1-4-1-1:2;  
D-1\FI-1-4-1-1:0;  
D-1\WFM-1-4-1-1:FW;  
COMMENT: \*\*\*\*\* C-Group \*\*\*\*\* ;  
COMMENT : Binary format, conversion type, and coefficients of TIREPRESSURE1 ;  
C-1\DCN:TIREPRESSURE1;  
C-1\MN1:Tire Pressure 1 - Left;  
C-1\BFM:TWO;  
C-1\DCT:COE;  
C-1\CO\N:1;  
C-1\CO:-5.12;  
C-1\CO-1:0.0025;  
COMMENT : Binary format, conversion type, and coefficients of TIREPRESSURE2 ;  
C-2\DCN:TIREPRESSURE2;  
C-2\MN1:Tire Pressure 2 - Right;  
C-2\BFM:TWO;  
C-2\DCT:COE;  
C-2\CO\N:1;  
C-2\CO:-5.12;  
C-2\CO-1:0.0025;  
COMMENT : Binary format, conversion type, and coefficients of  
ENGINETEMPERATURE;  
C-3\DCN:ENGINETEMPERATURE;  
C-3\MN1:Engine Temperature;  
C-3\BFM:TWO;  
C-3\DCT:COE;  
C-3\CO\N:1;  
C-3\CO:-5.12;  
C-3\CO-1:0.0025;  
COMMENT : Binary format, conversion type, and coefficients of  
CABINTEMPERATURE;  
C-4\DCN:CABINTEMPERATURE;  
C-4\MN1:Cabin Temperature;  
C-4\BFM:TWO;  
C-4\DCT:COE;  
C-4\CO\N:1;  
C-4\CO:-5.12;  
C-4\CO-1:0.0025;

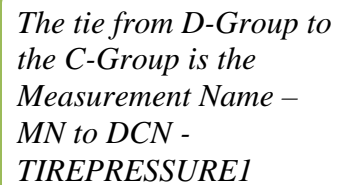

*The tie from D-Group to the C-Group is the Measurement Name – MN to DCN - TIREPRESSURE1*

## CHAPTER 4

### General Structure and Groups

Now that we've looked at a complete example, let's back up and look at the overall structure of TMATS.

Attribute information is organized according to a hierarchical structure in which related items are grouped and given a common heading. The number of levels varies within the overall structure and is a function of the logical association of the attributes.

Certain attributes known as ties are used to link the information in the various groups together. In database terminology, these attributes can be thought of as relational database keys. The TMATS code uses the attributes Data Source ID, Data Link Name, Channel Data Link Name, Subchannel Name, Network Name, Measurement Name, and Test Item for this purpose. **When an attribute is used as a tie (key), its value must be unique.**

At the highest level, the TM attributes are defined for the following groups.

Identifier	Title
G	General Information
T	Transmission Attributes
R	Recorder-Reproducer Attributes
M	Multiplexing/Modulation Attributes
P	PCM Format Attributes
D	PCM Measurement Description
B	Bus Data Attributes
S	Message Data Attributes
C	Data Conversion Attributes
H	Airborne Hardware Attributes
V	Vendor-Specific Attributes

The structure and relationships of the various groups of TMATS attributes are shown in [Figure 4-1](#).

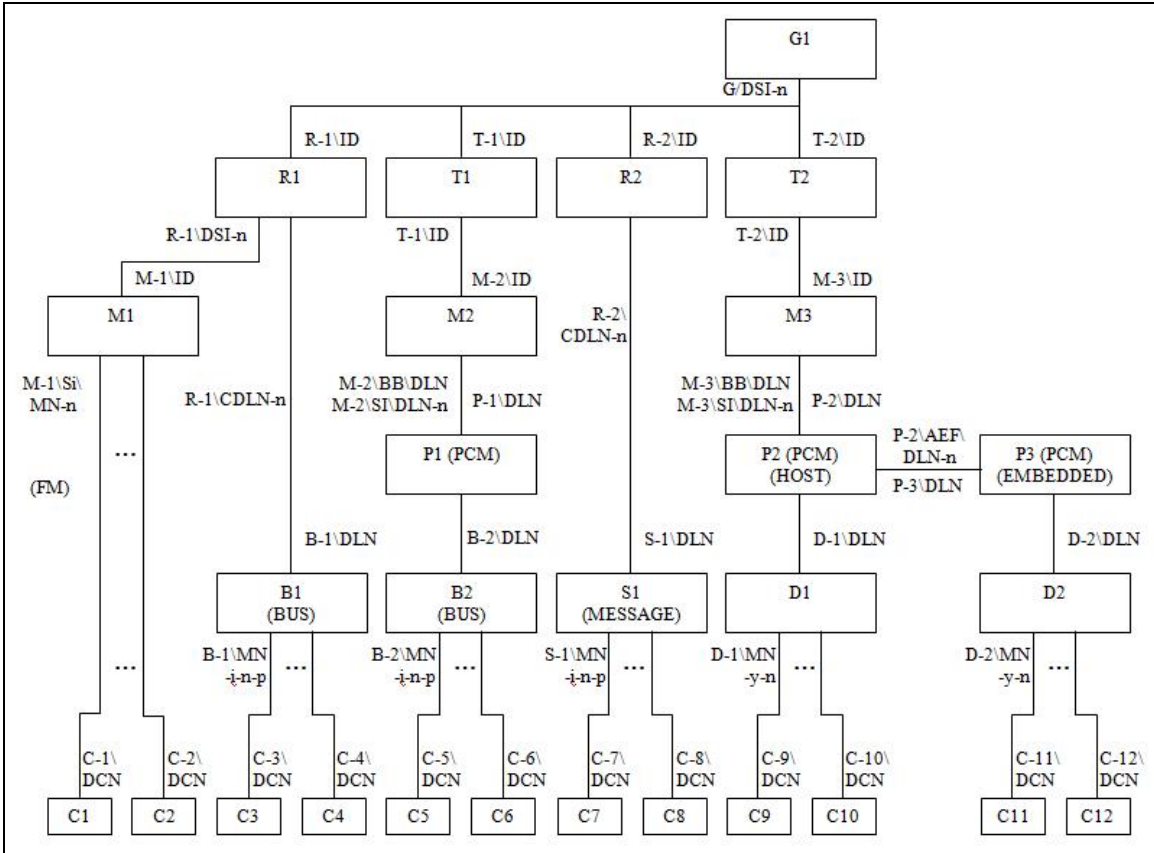

Figure 4-1. Group Relationships

The data source ID is unique within the G-Group. It ties the T-Group or the R-Group or both to the G-Group and to the M-Group.

The data source IDs could look like the following:

**G\DSI-1:SOURCE1;**  
**T-2\ID:SOURCE1;**  
**M-5\ID:SOURCE1;**

The tie from an M-Group to a P-Group is the data link name. The tie from a P-Group to an embedded P-Group is another data link name. The tie from the P-Group to a D-Group or a B-Group is also the data link name. If present, the Airborne Hardware Attributes Group (H-Group) uses the test item to tie into the G-Group and the Vendor-Specific Attributes Group (V-Group) uses the data link name to tie into the G-Group.

The data link names could have the following entries:

**M-5\BB\DLN:LINK1;**  
**P-3\DLN:LINK1;**  
**D-1\DLN:LINK1;**

The tie from an M-Group to the C-Group for an analog measurement is the measurement name. The tie from either the R-Group, D-Group, B-Group, or Message Data Attributes Group (S-Group) to the C-Group is the measurement name.

The measurement names could have the following entries:

**D-1\MN-1-1:MEAS1;**

**C-8\DCN:MEAS1;**

This page intentionally left blank.

## CHAPTER 5

### More TMATS Examples

#### 5.1 Examples for Various Measurement Location Types

The D-Group defines the frame location(s), parity, and bit mask for each measurement within the overall PCM format. The location of each measurement is specified by a measurement location type and further information appropriate for that type. The D-Group is tied to the P-Group and the M-Group via the data link name.

##### 5.1.1 General Information.

- a. Data Link Name. The D-Group is identified by a data link name, which must match the data link name of the corresponding P-Group. The group index corresponds to this D-Group.

**D-1\DLN:AIRCRAFT;**

- b. Number of Measurement Lists. The number of measurement lists within the D-Group is specified. Multiple measurement lists may be defined and grouped according to the test requirements. The typical case is to have one all-inclusive list, as shown here. The first index corresponds to the measurement list.

**D-1\ML\N:1;**

- c. Measurement List Name. Each measurement list is given a name; this could be just for identification, as shown here, or if Measurement List Change is used in the P-Group, it would match one of the measurement list names to be selected.

**D-1\MLN-1:INFLIGHT;**

- d. Number of Measurements. The number of measurements contained in each measurement list is specified. The second index corresponds to an individual measurement.

**D-1\MN\N-1:7;**

##### 5.1.2 Measurement Examples.

Several typical example measurements are given in this section. All will use the “word and frame” location type, which is the preferred method for locating measurements within the major frame described in the P-Group. Word and frame can be used to describe the traditional minor frame, subframe, and supercom location types, as shown below.

- a. Minor Frame Measurement. A minor frame measurement appears in exactly one word position within every minor frame. It is described using word and frame by specifying the word position in which it appears (with a word interval of 0 to indicate that it appears in only one word position) and using a frame interval of 1 to indicate that it appears in every minor frame. [Figure 5-1](#) highlights a minor frame measurement.

	Word 10	Word 12	Word 14	Word 17	Word 18	Word 23	Word 26	Word 28	Word 50
Frame 1	WFB	WFA		WFC	WFC				WFB
Frame 2	WFB	WFA			WFC				WFB
Frame 3	WFB	WFA			WFC				WFB
...	WFB	WFA			WFC				WFB
Frame 5	WFB	WFA			WFC	WFE			WFB
...	WFB	WFA			WFC				WFB
Frame 7	WFB	WFA	WFD		WFC				WFB
Frame 8	WFB	WFA			WFC		WFF	WFF	WFB
...	WFB	WFA			WFC				WFB
Frame 10	WFB	WFA			WFC				WFB
...	WFB	WFA			WFC				WFB
Frame 13	WFB	WFA		WFC	WFC	WFE			WFB
Etc. to end									

One location  
D-1\MML\N-1-1:1

Unfragmented  
D-1\MNF\N-1-1-1:1

Word position=12  
D-1\WP-1-1-1-1:12

Word interval=0  
D-1\WI-1-1-1-1:0

Frame position=1  
D-1\FP-1-1-1-1:1

Frame interval=1  
D-1\FI-1-1-1-1:1

Measurement name  
D-1\MN-1-2:WFB

Measurement name  
D-1\MN-1-1:WFA

Measurement name  
D-1\MN-1-4:WFD

Measurement name  
D-1\MN-1-3:WFC

Measurement name  
D-1\MN-1-5:WFE

Measurement name  
D-1\MN-1-6:WFF

Measurement name  
D-1\MN-1-6:WFF

Measurement name  
D-1\MN-1-2:WFB

Figure 5-1. Minor Frame Measurement

- (1) Measurement Name. This is the measurement name.  
**D-1\MN-1-1:WFA;**
- (2) Parity. The parity defaults to the P-Group parity entry.  
**D-1\MN1-1-1:DE;**
- (3) Parity Transfer Order. The parity transfer order defaults to the P-Group parity transfer order entry.  
**D-1\MN2-1-1:D;**
- (4) Measurement Transfer Order. The measurement transfer order defaults to the P-Group measurement transfer order entry.  
**D-1\MN3-1-1:D;**
- (5) Measurement Location Type. The location type is word and frame.  
**D-1\LT-1-1:WDFR;**
- (6) Number of Measurement Locations. The third index corresponds to an individual measurement location; one location definition is given.  
**D-1\MML\N-1-1:1;**
- (7) Number of Fragments. The fourth index corresponds to an individual fragment. A value of 1 indicates that this measurement is not fragmented.  
**D-1\MNF\N-1-1-1:1;**



- (8) Word Position and Word Interval. Word position 12 is the only word position used. In this case there is no interval, so the value for word interval will be 0.

**D-1\WP-1-1-1-1:12;**

**D-1\WI-1-1-1-1:0;**

- (9) Frame Position and Frame Interval. In this case, the measurement appears in every minor frame, so the value for the frame interval will be one. Start in frame position 1 and repeat in every minor frame.

**D-1\FP-1-1-1-1:1;**

**D-1\FI-1-1-1-1:1;**

- (10) Bit Mask. In this case, there is no bit masking; the entire word is used.

**D-1\WFM-1-1-1-1:FW;**

The XML snippet for the example above is shown in [Figure 5-2](#).

```
<TmatsD:Measurement Name="WFA">
  <TmatsD:Parity>Default</TmatsD:Parity>
  <TmatsD:ParityTransferOrder>Default</TmatsD:ParityTransferOrder>
  <TmatsD:MeasurementTransferOrder>Default</TmatsD:MeasurementTransferOrder>
  <TmatsD:LocationType>Word and Frame</TmatsD:LocationType>
  <TmatsD:WordAndFrame>
    <TmatsD:MeasurementLocation>
      <TmatsD:MeasurementFragments>
        <TmatsD:FragmentPosition>1</TmatsD:FragmentPosition>
        <TmatsD:FragmentTransferOrder>Default</TmatsD:FragmentTransferOrder>
        <TmatsD:StartWord>12</TmatsD:StartWord>
        <TmatsD:WordInterval>0</TmatsD:WordInterval>
        <TmatsD:StartFrame>1</TmatsD:StartFrame>
        <TmatsD:FrameInterval>1</TmatsD:FrameInterval>
        <TmatsD:BitMask>Full Word</TmatsD:BitMask>
      </TmatsD:MeasurementFragments>
    </TmatsD:MeasurementLocation>
  </TmatsD:WordAndFrame>
</TmatsD:Measurement>
```

Figure 5-2. Minor Frame Measurement Example XML

- b. Minor Frame Supercommutated Measurement. A minor frame supercommutated measurement appears in multiple word positions within every minor frame. It is described using word and frame by specifying the word positions in which it appears (by either giving the first word position and word interval, as in this example, or listing the word positions) and using a frame interval of 1 to indicate that each of its occurrences appears in every minor frame. [Figure 5-3](#) highlights a minor frame supercommutated measurement.

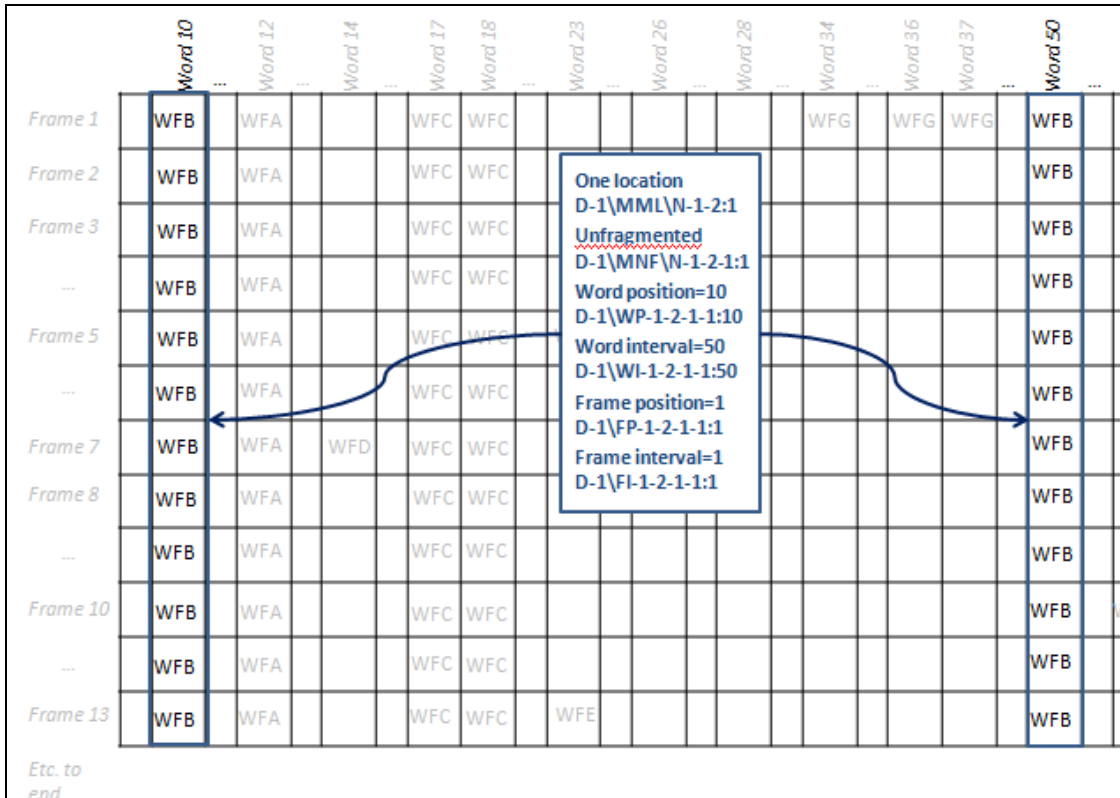

Figure 5-3. Minor Frame Supercommutated Measurement

**D-1\MN-1-2:WFB;**  
**D-1\MN1-1-2:DE;**  
**D-1\MN2-1-2:D;**  
**D-1\MN3-1-2:D;**  
**D-1\LT-1-2:WDFR;**  
**D-1\MML\N-1-2:1;**  
**D-1\MNF\N-1-2-1:1;**

- (1) Start in word position 10, repeat every 50 words until the end of minor frame.  
**D-1\WP-1-2-1-1:10;**  
**D-1\WI-1-2-1-1:50;**
- (2) Start in frame position 1, repeat in every minor frame.  
**D-1\FP-1-2-1-1:1;**  
**D-1\FI-1-2-1-1:1;**  
**D-1\WFM-1-2-1-1:FW;**

The XML snippet for the example above is shown in [Figure 5-4](#).

```

<TmatsD:Measurement Name="WFB">
  <TmatsD:Parity>Default</TmatsD:Parity>
  <TmatsD:ParityTransferOrder>Default</TmatsD:ParityTransferOrder>
  <TmatsD:MeasurementTransferOrder>Default</TmatsD:MeasurementTransferOrder>
  <TmatsD:LocationType>Word and Frame</TmatsD:LocationType>
  <TmatsD:WordAndFrame>
    <TmatsD:MeasurementLocation>
      <TmatsD:MeasurementFragments>
        <TmatsD:FragmentPosition>1</TmatsD:FragmentPosition>
        <TmatsD:FragmentTransferOrder>Default</TmatsD:FragmentTransferOrder>
        <TmatsD:StartWord>10</TmatsD:StartWord>
        <TmatsD:WordInterval>50</TmatsD:WordInterval>
        <TmatsD:StartFrame>1</TmatsD:StartFrame>
        <TmatsD:EndFrame>1</TmatsD:EndFrame>
        <TmatsD:BitMask>Full Word</TmatsD:BitMask>
      </TmatsD:MeasurementFragments>
    </TmatsD:MeasurementLocation>
  </TmatsD:WordAndFrame>
</TmatsD:Measurement>

```

Figure 5-4. Minor Frame Supercommutated Measurement Example XML

- c. **Minor Frame Fragmented Measurement.** A minor frame fragmented measurement spans multiple word positions because its length is greater than the common word length. Each of its fragments appears in exactly one word position within every minor frame; the measurement is obtained by concatenating the fragments. It is described using word and frame by specifying the word position in which each fragment appears with a word interval of 0 to indicate that the fragment appears in only one word position. Also, a frame interval of 1 is used to indicate that each fragment appears in every minor frame. The correct order is specified to concatenate the fragments. [Figure 5-5](#) highlights a minor frame fragmented measurement.

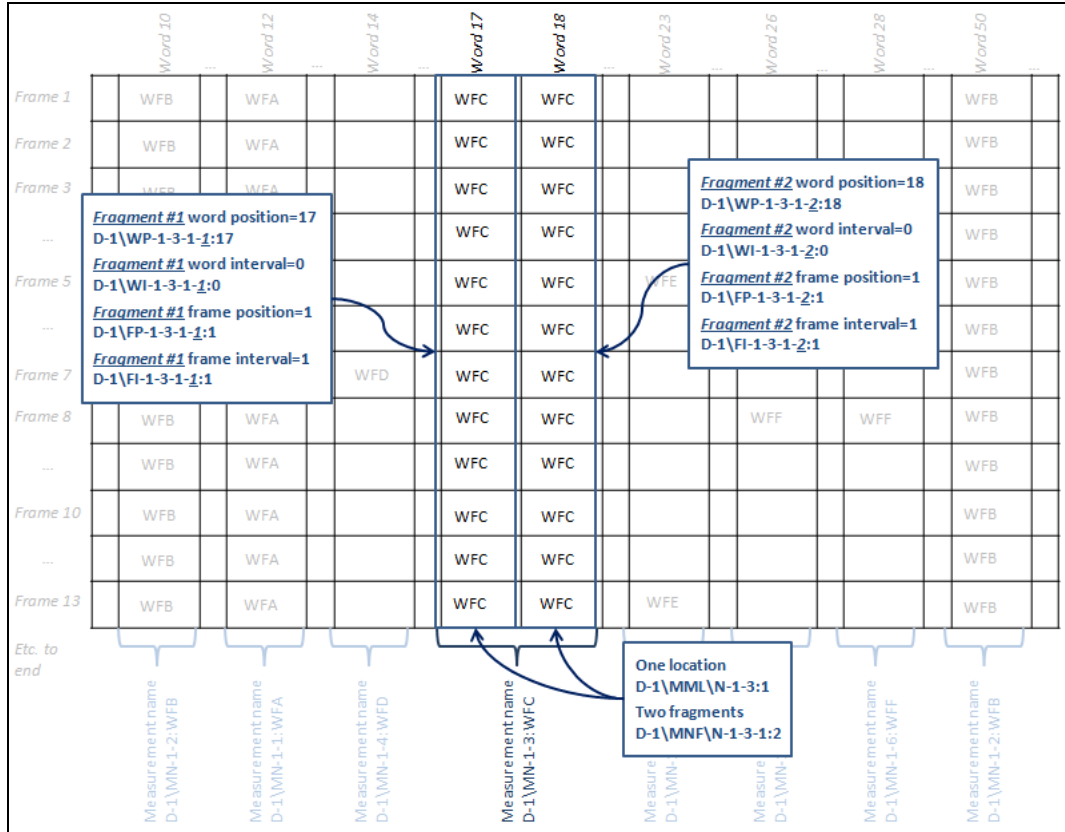

Figure 5-5. Minor Frame Fragmented Measurement

**D-1\MN-1-3:WFC;**  
**D-1\MN1-1-3:DE;**  
**D-1\MN2-1-3:D;**  
**D-1\MN3-1-3:D;**  
**D-1\LT-1-3:WDFR;**  
**D-1\MML\N-1-3:1;**

- (1) Number of Fragments. This measurement consists of 2 fragments.  
**D-1\MNF\N-1-3-1:2;**
- (2) The first fragment. Located in word position 17, in every frame.  
**D-1\WP-1-3-1-1:17;**  
**D-1\WI-1-3-1-1:0;**  
**D-1\FP-1-3-1-1:1;**  
**D-1\FI-1-3-1-1:1;**  
**D-1\WFM-1-3-1-1:FW;**
- (3) Fragment Transfer Order. The fragment transfer order defaults to the P-Group measurement transfer order entry.  
**D-1\WFT-1-3-1-1:D;**
- (4) Fragment Position. This is the most significant fragment.  
**D-1\WFP-1-3-1-1:1;**

- (5) The second fragment. Located in word position 18, in every frame.

**D-1\WP-1-3-1-2:18;**

**D-1\WI-1-3-1-2:0;**

**D-1\FP-1-3-1-2:1;**

**D-1\FI-1-3-1-2:1;**

- (6) The most significant 4 bits are used.

**D-1\WFM-1-3-1-2:111100000000;**

**D-1\WFT-1-3-1-2:D;**

- (7) Least significant fragment.

**D-1\WFP-1-3-1-2:2;**

The XML snippet for the example above is shown in [Figure 5-6](#).

```
<TmatsD:Measurement Name="WFC">
  <TmatsD:Parity>Default</TmatsD:Parity>
  <TmatsD:ParityTransferOrder>Default</TmatsD:ParityTransferOrder>
  <TmatsD:MeasurementTransferOrder>Default</TmatsD:MeasurementTransferOrder>
  <TmatsD:LocationType>Word and Frame</TmatsD:LocationType>
  <TmatsD:WordAndFrame>
    <TmatsD:MeasurementLocation>
      <TmatsD:MeasurementFragments>
        <TmatsD:FragmentPosition>1</TmatsD:FragmentPosition>
        <TmatsD:FragmentTransferOrder>Default</TmatsD:FragmentTransferOrder>
        <TmatsD:StartWord>17</TmatsD:StartWord>
        <TmatsD:WordInterval>0</TmatsD:WordInterval>
        <TmatsD:StartFrame>1</TmatsD:StartFrame>
        <TmatsD:FrameInterval>0</TmatsD:FrameInterval>
        <TmatsD:BitMask>Full Word</TmatsD:BitMask>
      </TmatsD:MeasurementFragments>
      <TmatsD:MeasurementFragments>
        <TmatsD:FragmentPosition>2</TmatsD:FragmentPosition>
        <TmatsD:FragmentTransferOrder>Default</TmatsD:FragmentTransferOrder>
        <TmatsD:StartWord>18</TmatsD:StartWord>
        <TmatsD:WordInterval>0</TmatsD:WordInterval>
        <TmatsD:StartFrame>1</TmatsD:StartFrame>
        <TmatsD:FrameInterval>1</TmatsD:FrameInterval>
        <TmatsD:BitMask>111100000000</TmatsD:BitMask>
      </TmatsD:MeasurementFragments>
    </TmatsD:MeasurementLocation>
  </TmatsD:WordAndFrame>
</TmatsD:Measurement>
```

Figure 5-6. Minor Frame Fragmented Measurement Example XML

- d. Subframe Measurement. A subframe measurement appears in exactly one word position within exactly one minor frame. It is described using word and frame by specifying the one word position (with a word interval of 0, indicating that it appears in only one word position) and one frame position (with a frame interval of 0, indicating that it appears in only one frame position) in which it appears. [Figure 5-7](#) highlights a subframe measurement.

	Word 10	...	Word 12	...	Word 14	...	Word 17	Word 18	...	Word 23	...	Word 26	...	Word 28	...	Word 34	...	Word 36	Word 37	...	Word 50	...		
Frame 1	WFB		WFA				WFC	WFC								WFG		WFG	WFG			WFB		
Frame 2	WFB		WFA				WFC	WFC															WFB	
Frame 3	WFB		WFA				WFC	WFC															WFB	
...	WFB		WFA				WFC	WFC															WFB	
Frame 5	WFB		WFA				WFC	WFC															WFB	
...	WFB		WFA				WFC	WFC															WFB	
Frame 7	WFB		WFA		WFD		WFC	WFC															WFB	
Frame 8	WFB		WFA				WFC	WFC															WFB	
...	WFB		WFA				WFC	WFC															WFB	
Frame 10	WFB		WFA				WFC	WFC															WFB	
...	WFB		WFA				WFC	WFC															WFB	
Frame 13	WFB		WFA				WFC	WFC		WFE													WFB	
Etc. to end																								

One location  
D-1\MML\N-1-4:1  
Unfragmented  
D-1\MNF\N-1-4-1:1  
Word position=14  
D-1\WP-1-4-1-1:14  
Word interval=0  
D-1\WI-1-4-1-1:0  
Frame position=7  
D-1\FP-1-4-1-1:7  
Frame interval=0  
D-1\FI-1-4-1-1:0

Figure 5-7. Subframe Measurement

**D-1\MN-1-4:WFD;**  
**D-1\MN1-1-4:DE;**  
**D-1\MN2-1-4:D;**  
**D-1\MN3-1-4:D;**  
**D-1\LT-1-4:WDFR;**  
**D-1\MML\N-1-4:1;**  
**D-1\MNF\N-1-4-1:1;**

- (1) Word position 14. The only word position used.  
**D-1\WP-1-4-1-1:14;**  
**D-1\WI-1-4-1-1:0;**
- (2) Frame position 7. The only frame position used.  
**D-1\FP-1-4-1-1:7;**  
**D-1\FI-1-4-1-1:0;**
- (3) No bit masking. The entire word is used.  
**D-1\WFM-1-4-1-1:FW;**

The XML snippet for the example above is shown in [Figure 5-8](#).

```

<TmatsD:Measurement Name="WFD">
  <TmatsD:Parity>Default</TmatsD:Parity>
  <TmatsD:ParityTransferOrder>Default</TmatsD:ParityTransferOrder>
  <TmatsD:MeasurementTransferOrder>Default</TmatsD:MeasurementTransferOrder>
  <TmatsD:LocationType>Word and Frame</TmatsD:LocationType>
  <TmatsD:WordAndFrame>
    <TmatsD:MeasurementLocation>
      <TmatsD:MeasurementFragments>
        <TmatsD:FragmentPosition>1</TmatsD:FragmentPosition>
        <TmatsD:FragmentTransferOrder>Default</TmatsD:FragmentTransferOrder>
        <TmatsD:StartWord>14</TmatsD:StartWord>
        <TmatsD:WordInterval>0</TmatsD:WordInterval>
        <TmatsD:StartFrame>7</TmatsD:StartFrame>
        <TmatsD:FrameInterval>0</TmatsD:FrameInterval>
        <TmatsD:BitMask>Full Word</TmatsD:BitMask>
      </TmatsD:MeasurementFragments>
    </TmatsD:MeasurementLocation>
  </TmatsD:WordAndFrame>
</TmatsD:Measurement>

```

Figure 5-8. Subframe Measurement Example XML

- e. Subframe Supercommutated Measurement. A subframe supercommutated measurement appears in multiple frame positions within exactly one word position. It is described using word and frame by specifying the one word position (with a word interval of 0 to indicate that it appears in only one word position) and multiple frame positions in which it appears (by either giving the first frame position and frame interval, as in this example, or listing the frame positions). [Figure 5-9](#) displays a subframe supercommutated measurement.

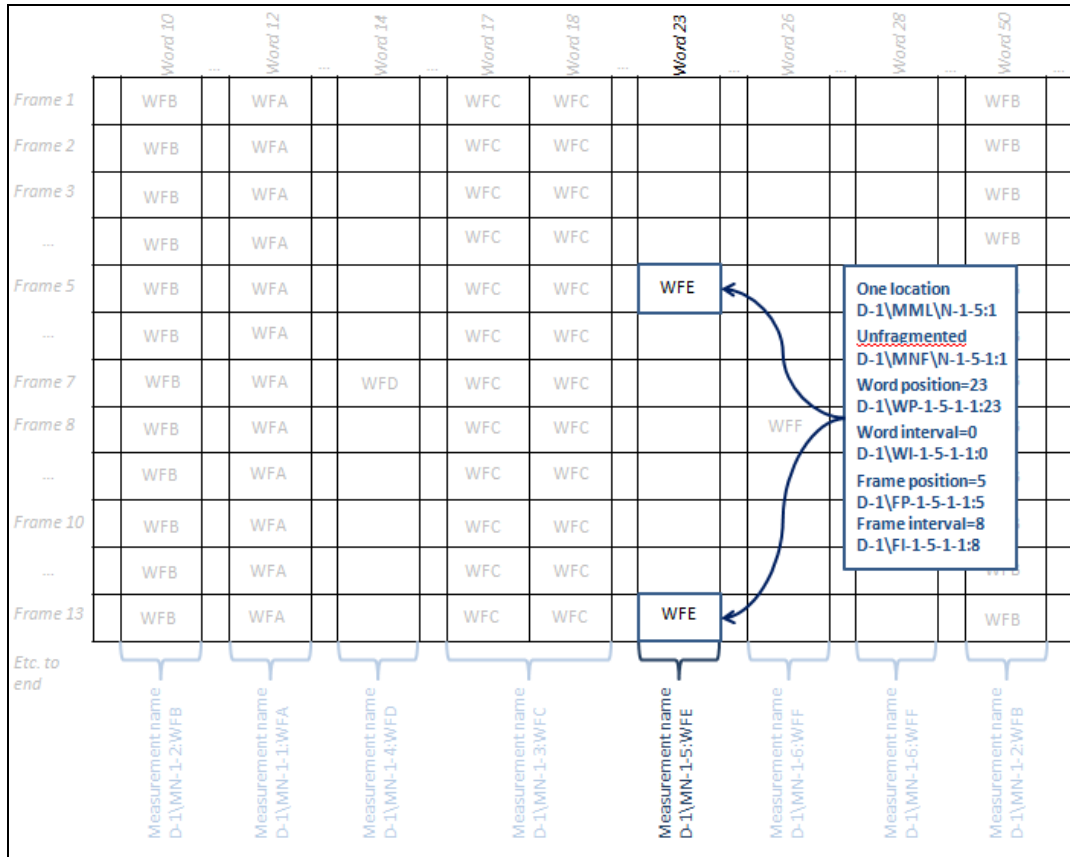

Figure 5-9. Subframe Supercommutated Measurement

**D-1\MN-1-5:WFE;**  
**D-1\MN1-1-5:DE;**  
**D-1\MN2-1-5:D;**  
**D-1\MN3-1-5:D;**  
**D-1\LT-1-5:WDFR;**  
**D-1\MML\N-1-5:1;**  
**D-1\MNF\N-1-5-1:1;**

- (1) Word position 23. The only word position used.  
**D-1\WP-1-5-1-1:23;**  
**D-1\WI-1-5-1-1:0;**
- (2) Start in frame position 5.  
**D-1\FP-1-5-1-1:5;**
- (3) Repeat every 8 frames until the end of the major frame.  
**D-1\FI-1-5-1-1:8;**
- (4) No bit masking. The entire word is used.  
**D-1\WFM-1-5-1-1:FW;**

The XML snippet for the example above is shown in [Figure 5-10](#).



```

<TmatsD:Measurement Name="WFE">
  <TmatsD:Parity>Default</TmatsD:Parity>
  <TmatsD:ParityTransferOrder>Default</TmatsD:ParityTransferOrder>
  <TmatsD:MeasurementTransferOrder>Default</TmatsD:MeasurementTransferOrder>
  <TmatsD:LocationType>Word and Frame</TmatsD:LocationType>
  <TmatsD:WordAndFrame>
    <TmatsD:MeasurementLocation>
      <TmatsD:MeasurementFragments>
        <TmatsD:FragmentPosition>1</TmatsD:FragmentPosition>
        <TmatsD:FragmentTransferOrder>Default</TmatsD:FragmentTransferOrder>
        <TmatsD:StartWord>23</TmatsD:StartWord>
        <TmatsD:WordInterval>0</TmatsD:WordInterval>
        <TmatsD:StartFrame>5</TmatsD:StartFrame>
        <TmatsD:FrameInterval>8</TmatsD:FrameInterval>
        <TmatsD:BitMask>Full Word</TmatsD:BitMask>
      </TmatsD:MeasurementFragments>
    </TmatsD:MeasurementLocation>
  </TmatsD:WordAndFrame>
</TmatsD:Measurement>

```

Figure 5-10. Subframe Supercommutated Measurement Example XML

- f. **Subframe Fragmented Measurement.** A subframe fragmented measurement spans multiple word positions because its length is greater than the common word length. Each of its fragments appears in exactly one word position within exactly one minor frame; the measurement is obtained by concatenating the fragments. It is described using word and frame by specifying the one word position (with a word interval of 0 to indicate that it appears in only one word position) and one frame position (with a frame interval of 0 to indicate that it appears in only one frame position) in which each fragment appears and specifying the correct order to concatenate the fragments. [Figure 5-11](#) highlights a subframe fragmented measurement.

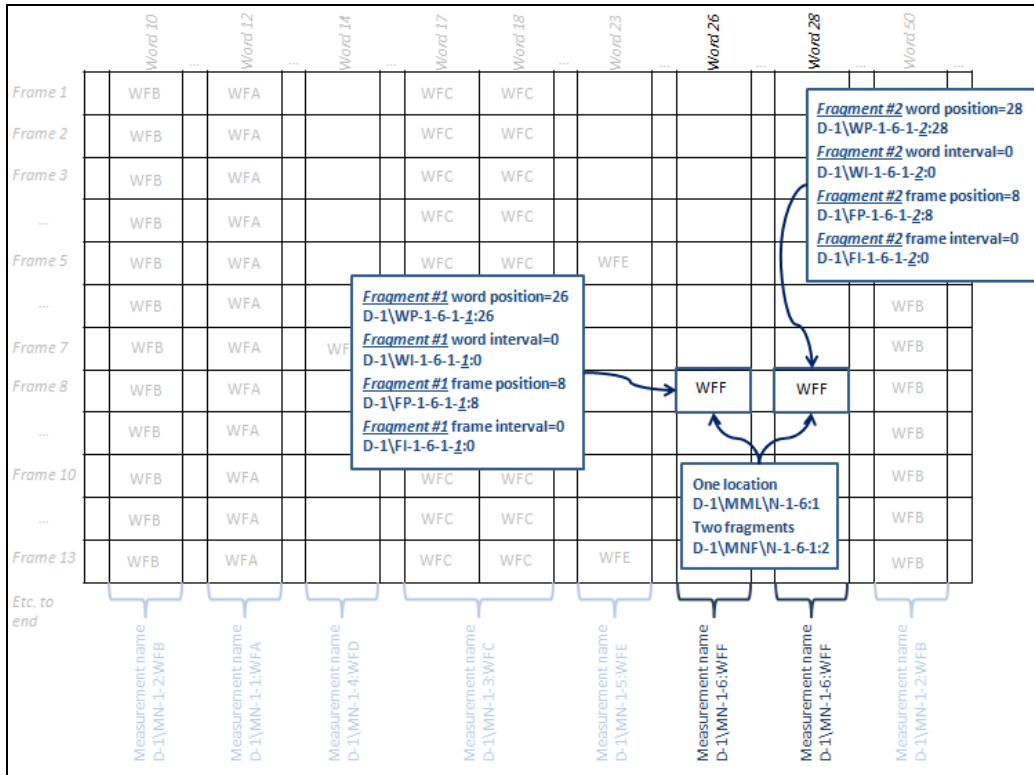

Figure 5-11. Subframe Fragmented Measurement

**D-1\MN-1-6:WFF;**  
**D-1\MN1-1-6:DE;**  
**D-1\MN2-1-6:D;**  
**D-1\MN3-1-6:D;**  
**D-1\LT-1-6:WDFR;**  
**D-1\MML\N-1-6:1;**  
**D-1\MNF\N-1-6-1:2;**

- (1) First Fragment. The first fragment is located in word position 26, frame 8.  
**D-1\WP-1-6-1-1:26;**  
**D-1\WI-1-6-1-1:0;**  
**D-1\FP-1-6-1-1:8;**  
**D-1\FI-1-6-1-1:0;**  
**D-1\WFM-1-6-1-1:FW;**  
**D-1\WFT-1-6-1-1:D;**  
**D-1\WFP-1-6-1-1:1;**
  
- (2) Second Fragment. The second fragment is located in word position 28, frame 8.  
**D-1\WP-1-6-1-2:28;**  
**D-1\WI-1-6-1-2:0;**  
**D-1\FP-1-6-1-2:8;**  
**D-1\FI-1-6-1-2:0;**  
**D-1\WFM-1-6-1-2:111100000000;**  
**D-1\WFT-1-6-1-2:D;**

**D-1\WFP-1-6-1-2:2;**

The XML snippet for the example above is shown in [Figure 5-12](#).

```

<TmatsD:Measurement Name="WFF">
  <TmatsD:Parity>Default</TmatsD:Parity>
  <TmatsD:ParityTransferOrder>Default</TmatsD:ParityTransferOrder>
  <TmatsD:MeasurementTransferOrder>Default</TmatsD:MeasurementTransferOrder>
  <TmatsD:LocationType>Word and Frame</TmatsD:LocationType>
  <TmatsD:WordAndFrame>
    <TmatsD:MeasurementLocation>
      <TmatsD:MeasurementFragments>
        <TmatsD:FragmentTransferOrder>Default</TmatsD:FragmentTransferOrder>
        <TmatsD:StartWord>26</TmatsD:StartWord>
        <TmatsD:WordInterval>0</TmatsD:WordInterval>
        <TmatsD:StartFrame>8</TmatsD:StartFrame>
        <TmatsD:FrameInterval>0</TmatsD:FrameInterval>
        <TmatsD:BitMask>Full Word</TmatsD:BitMask>
      </TmatsD:MeasurementFragments>
    </TmatsD:MeasurementLocation>
    <TmatsD:MeasurementLocation>
      <TmatsD:MeasurementFragments>
        <TmatsD:FragmentPosition>2</TmatsD:FragmentPosition>
        <TmatsD:FragmentTransferOrder>Default</TmatsD:FragmentTransferOrder>
        <TmatsD:StartWord>28</TmatsD:StartWord>
        <TmatsD:WordInterval>0</TmatsD:WordInterval>
        <TmatsD:StartFrame>8</TmatsD:StartFrame>
        <TmatsD:FrameInterval>0</TmatsD:FrameInterval>
        <TmatsD:BitMask>111100000000</TmatsD:BitMask>
      </TmatsD:MeasurementFragments>
    </TmatsD:MeasurementLocation>
  </TmatsD:WordAndFrame>
</TmatsD:Measurement>

```

Figure 5-12. Subframe Fragmented Measurement Example XML

### 5.1.3 Additional Measurement Examples.

Word and frame can also be used to give the location of measurements that could not be described by the traditional minor frame, subframe, and supercom location types. Two examples are given below.

- a. Subframe Fragmented Measurement in Multiple Locations. The subframe fragmented measurement described in paragraph [5.1.2f](#) appeared in only one location. Using word and frame, it is possible to describe a subframe fragmented measurement in multiple locations anywhere in the major frame. The following example, illustrated in [Figure 5-13](#) and [Figure 5-14](#), shows a measurement with three noncontiguous fragments that appears in two unevenly spaced locations. It is described by simply listing the word and frame positions of each of the fragments and the order of the fragments for each of the locations.

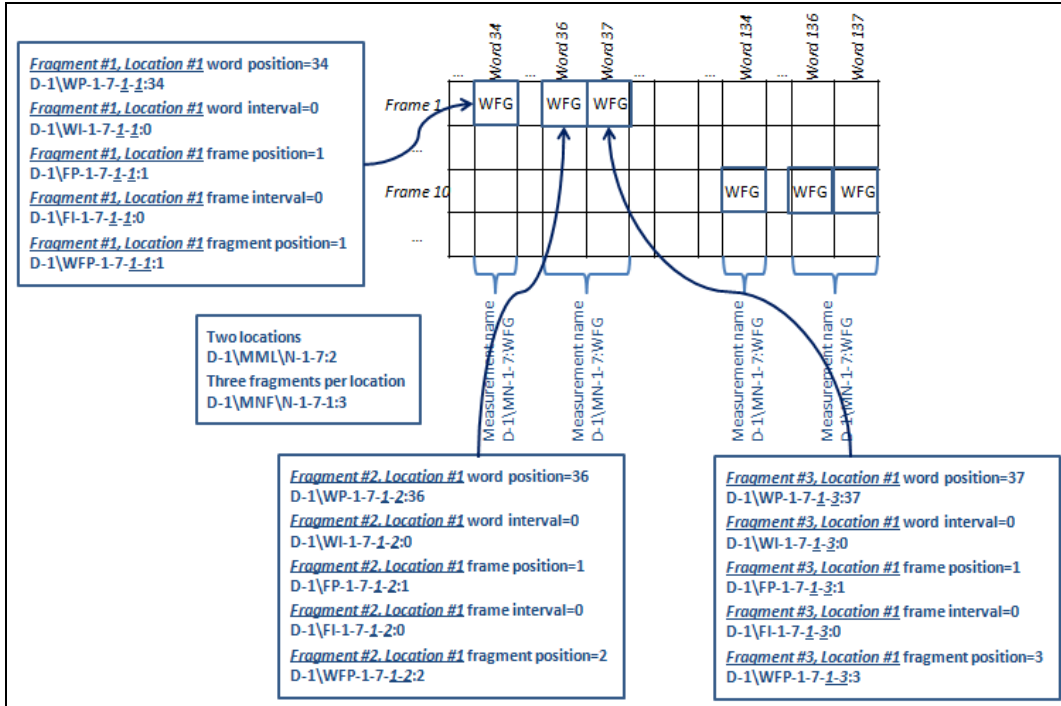

Figure 5-13. Subframe Fragmented Measurement in Multiple Locations (Location 1)

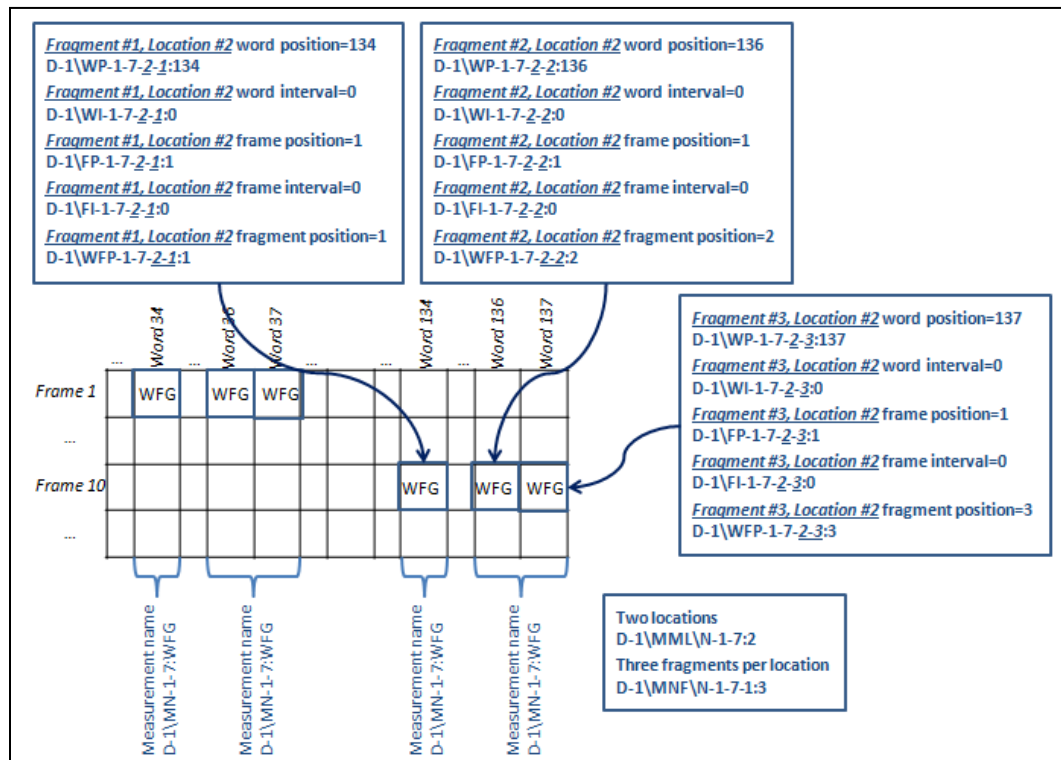

Figure 5-14. Subframe Fragmented Measurement in Multiple Locations (Location 2)

**D-1\MN-1-7:WFG;**  
**D-1\MN1-1-7:DE;**  
**D-1\MN2-1-7:D;**  
**D-1\MN3-1-7:D;**  
**D-1\LT-1-7:WDFR;**

- (1) Two Locations. There are two locations of this measurement - the measurement occurs twice within the major frame.

**D-1\MML\N-1-7:2;**

- (2) Number of fragments. Each measurement location consists of three fragments.

**D-1\MNF\N-1-7-1:3;**

- (3) First location, first fragment. The following is illustrated in [Figure 5-15](#).

**D-1\WP-1-7-1-1:34;**  
**D-1\WI-1-7-1-1:0;**  
**D-1\FP-1-7-1-1:1;**  
**D-1\FI-1-7-1-1:0;**  
**D-1\WFM-1-7-1-1:FW;**  
**D-1\WFT-1-7-1-1:D;**  
**D-1\WFP-1-7-1-1:1;**

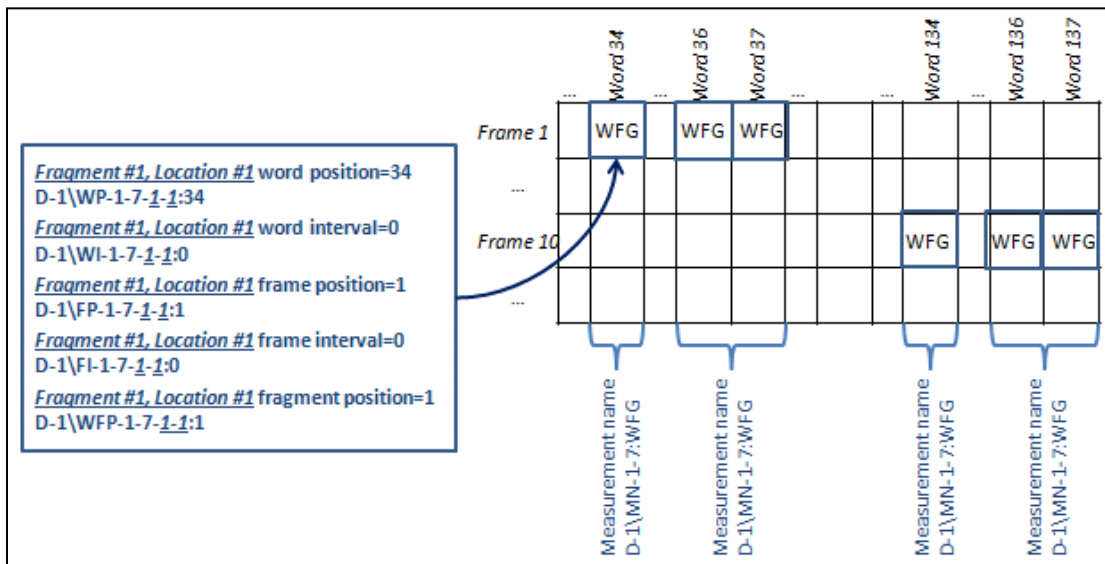

Figure 5-15. Subframe Fragmented Measurement in Multiple Locations (Location 1, Fragment 1)

- (4) First Location, Second Fragment. The following is illustrated in [Figure 5-16](#).

**D-1\WP-1-7-1-2:36;**  
**D-1\WI-1-7-1-2:0;**  
**D-1\FP-1-7-1-2:1;**  
**D-1\FI-1-7-1-2:0;**  
**D-1\WFM-1-7-1-2:FW;**  
**D-1\WFT-1-7-1-2:D;**  
**D-1\WFP-1-7-1-2:2;**

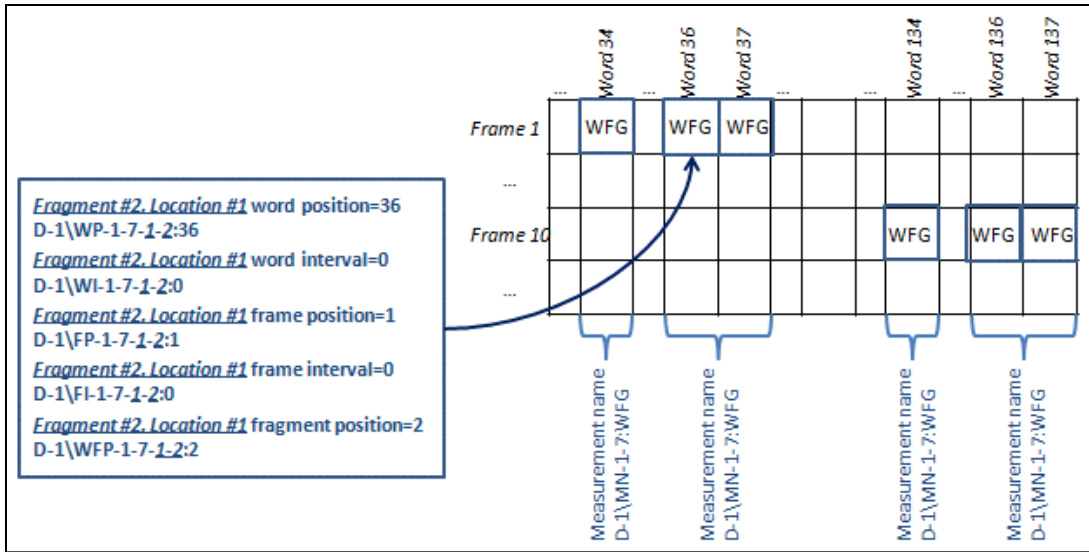

Figure 5-16. Subframe Fragmented Measurement in Multiple Locations (Location 1, Fragment 2)

(5) First Location, Third Fragment. The following is illustrated in [Figure 5-17](#).

**D-1\WP-1-7-1-3:37;**  
**D-1\WI-1-7-1-3:0;**  
**D-1\FP-1-7-1-3:1;**  
**D-1\FI-1-7-1-3:0;**  
**D-1\WFM-1-7-1-3:11111110000;**  
**D-1\WFT-1-7-1-3:D;**  
**D-1\WFP-1-7-1-3:3;**

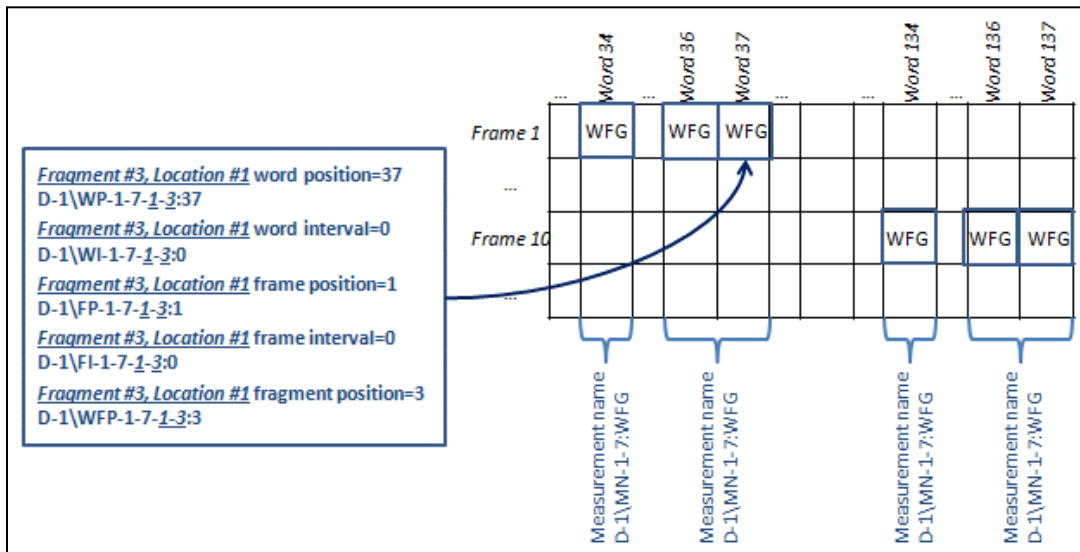

Figure 5-17. Subframe Fragmented Measurement in Multiple Locations (Location 1, Fragment 3)

(6) Second Location, First Fragment. The following is illustrated in [Figure 5-18](#).

**D-1\WP-1-7-2-1:134;**  
**D-1\WI-1-7-2-1:0;**  
**D-1\FP-1-7-2-1:10;**  
**D-1\FI-1-7-2-1:0;**  
**D-1\WFM-1-7-2-1:111111111111;**  
**D-1\WFT-1-7-2-1:D;**  
**D-1\WFP-1-7-2-1:1;**

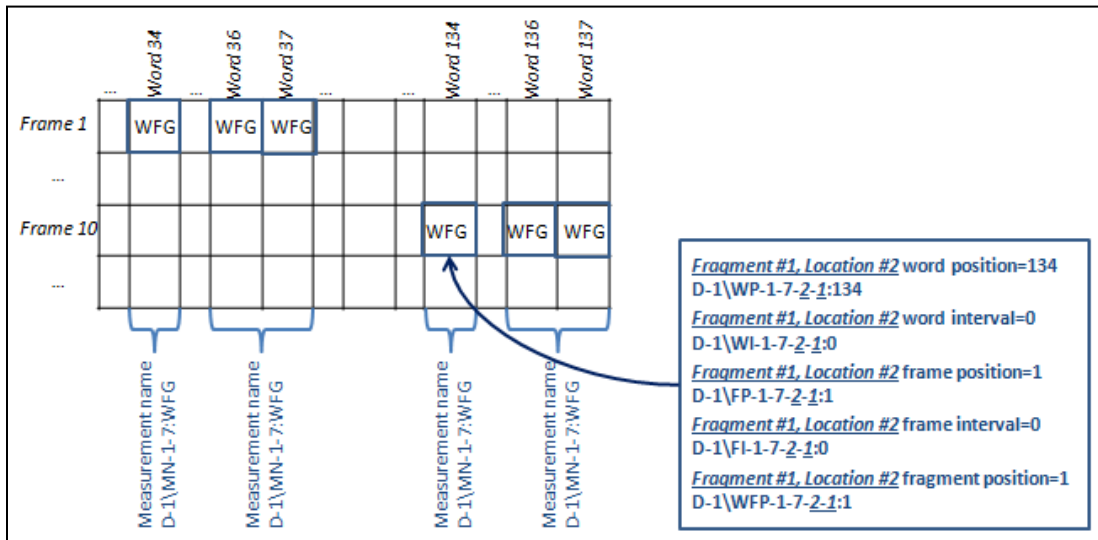

Figure 5-18. Subframe Fragmented Measurement in Multiple Locations  
 (Location 2, Fragment 1)

(7) Second location, second fragment. The following is illustrated in [Figure 5-19](#).

**D-1\WP-1-7-2-2:136;**  
**D-1\WI-1-7-2-2:0;**  
**D-1\FP-1-7-2-2:10;**  
**D-1\FI-1-7-2-2:0;**  
**D-1\WFM-1-7-2-2:111111111111;**  
**D-1\WFT-1-7-2-2:D;**  
**D-1\WFP-1-7-2-2:2;**

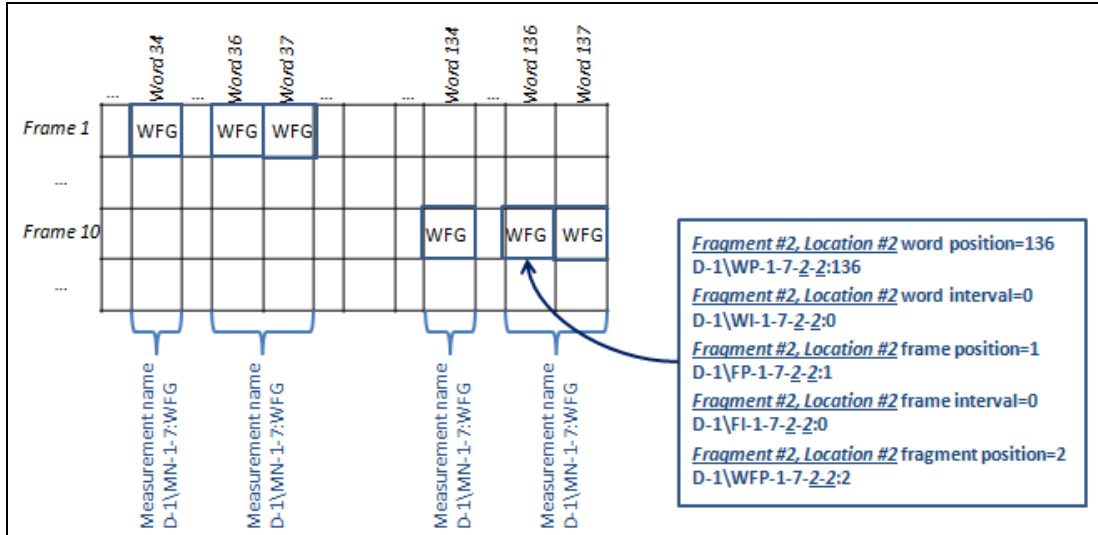

Figure 5-19. Subframe Fragmented Measurement in Multiple Locations (Location 2, Fragment 2)

(8) Second Location, Third Fragment. The following is illustrated in [Figure 5-20](#).

**D-1\WP-1-7-2-3:137;**  
**D-1\WI-1-7-2-3:0;**  
**D-1\FP-1-7-2-3:10;**  
**D-1\FI-1-7-2-3:0;**  
**D-1\WFM-1-7-2-3:11111110000;**  
**D-1\WFT-1-7-2-3:D;**  
**D-1\WFP-1-7-2-3:3;**

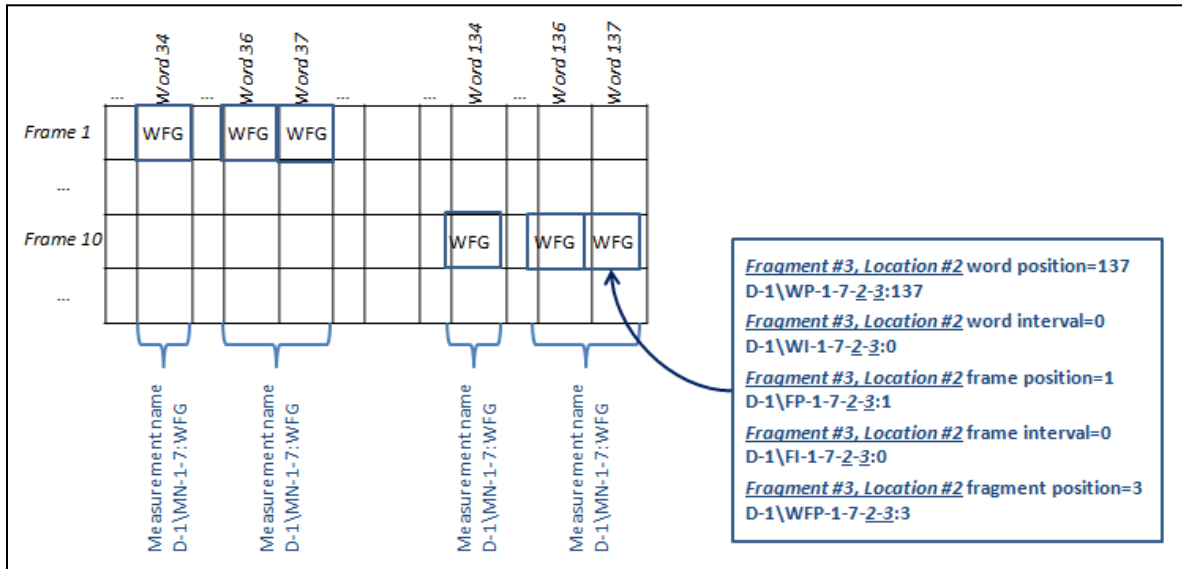

Figure 5-20. Subframe Fragmented Measurement in Multiple Locations (Location 2, Fragment 3)

The XML snippet for the example above is shown in [Figure 5-21](#).



```

<TmatsD:Measurement Name="WFG">
  <TmatsD:Parity>Default</TmatsD:Parity>
  <TmatsD:ParityTransferOrder>Default</TmatsD:ParityTransferOrder>
  <TmatsD:MeasurementTransferOrder>Default</TmatsD:MeasurementTransferOrder>
  <TmatsD:LocationType>Word and Frame</TmatsD:LocationType>
  <TmatsD:WordAndFrame>
    <TmatsD:MeasurementLocation>
      <TmatsD:MeasurementFragments>
        <TmatsD:FragmentPosition>1</TmatsD:FragmentPosition>
        <TmatsD:FragmentTransferOrder>Default</TmatsD:FragmentTransferOrder>
        <TmatsD:StartWord>34</TmatsD:StartWord>
        <TmatsD:WordInterval>0</TmatsD:WordInterval>
        <TmatsD:StartFrame>1</TmatsD:StartFrame>
        <TmatsD:FrameInterval>0</TmatsD:FrameInterval>
        <TmatsD:BitMask>Full Word</TmatsD:BitMask>
      </TmatsD:MeasurementFragments>
      <TmatsD:MeasurementFragments>
        <TmatsD:FragmentPosition>2</TmatsD:FragmentPosition>
        <TmatsD:FragmentTransferOrder>Default</TmatsD:FragmentTransferOrder>
        <TmatsD:StartWord>36</TmatsD:StartWord>
        <TmatsD:WordInterval>0</TmatsD:WordInterval>
        <TmatsD:StartFrame>1</TmatsD:StartFrame>
        <TmatsD:FrameInterval>0</TmatsD:FrameInterval>
        <TmatsD:BitMask>Full Word</TmatsD:BitMask>
      </TmatsD:MeasurementFragments>
      <TmatsD:MeasurementFragments>
        <TmatsD:FragmentPosition>3</TmatsD:FragmentPosition>
        <TmatsD:FragmentTransferOrder>Default</TmatsD:FragmentTransferOrder>
        <TmatsD:StartWord>37</TmatsD:StartWord>
        <TmatsD:WordInterval>0</TmatsD:WordInterval>
        <TmatsD:StartFrame>1</TmatsD:StartFrame>
        <TmatsD:FrameInterval>0</TmatsD:FrameInterval>
        <TmatsD:BitMask>111111110000</TmatsD:BitMask>
      </TmatsD:MeasurementFragments>
    </TmatsD:MeasurementLocation>
    <TmatsD:MeasurementLocation>
      <TmatsD:MeasurementFragments>
        <TmatsD:FragmentPosition>1</TmatsD:FragmentPosition>
        <TmatsD:FragmentTransferOrder>Default</TmatsD:FragmentTransferOrder>
        <TmatsD:StartWord>134</TmatsD:StartWord>
        <TmatsD:WordInterval>0</TmatsD:WordInterval>
        <TmatsD:StartFrame>10</TmatsD:StartFrame>
        <TmatsD:FrameInterval>0</TmatsD:FrameInterval>
        <TmatsD:BitMask>111111111111</TmatsD:BitMask>
      </TmatsD:MeasurementFragments>
      <TmatsD:MeasurementFragments>
        <TmatsD:FragmentPosition>2</TmatsD:FragmentPosition>
        <TmatsD:FragmentTransferOrder>Default</TmatsD:FragmentTransferOrder>
        <TmatsD:StartWord>136</TmatsD:StartWord>
        <TmatsD:WordInterval>0</TmatsD:WordInterval>
        <TmatsD:StartFrame>10</TmatsD:StartFrame>
        <TmatsD:FrameInterval>0</TmatsD:FrameInterval>
        <TmatsD:BitMask>111111111111</TmatsD:BitMask>
      </TmatsD:MeasurementFragments>
      <TmatsD:MeasurementFragments>
        <TmatsD:FragmentPosition>3</TmatsD:FragmentPosition>
        <TmatsD:FragmentTransferOrder>Default</TmatsD:FragmentTransferOrder>
        <TmatsD:StartWord>137</TmatsD:StartWord>
        <TmatsD:WordInterval>0</TmatsD:WordInterval>
        <TmatsD:StartFrame>10</TmatsD:StartFrame>
        <TmatsD:FrameInterval>0</TmatsD:FrameInterval>
        <TmatsD:BitMask>111111110000</TmatsD:BitMask>
      </TmatsD:MeasurementFragments>
    </TmatsD:MeasurementLocation>
  </TmatsD:WordAndFrame>
</TmatsD:Measurement>

```

Figure 5-21. Subframe Fragmented Measurement in Multiple Locations  
Example XML

- b. Minor Frame Fragmented and Supercommutated Measurement. The minor frame fragmented measurement described in a previous example in paragraph 5.1.2c appeared in only one location. Using word and frame, it is possible to describe a minor frame fragmented measurement that appears more than once in every minor frame (i.e., is supercommutated). The following example, displayed in Figure 5-22, shows a measurement consisting of two fragments that appears twice in each minor frame. It is described by specifying the word and frame positions of each fragment and the order of the fragments for each of the two locations.

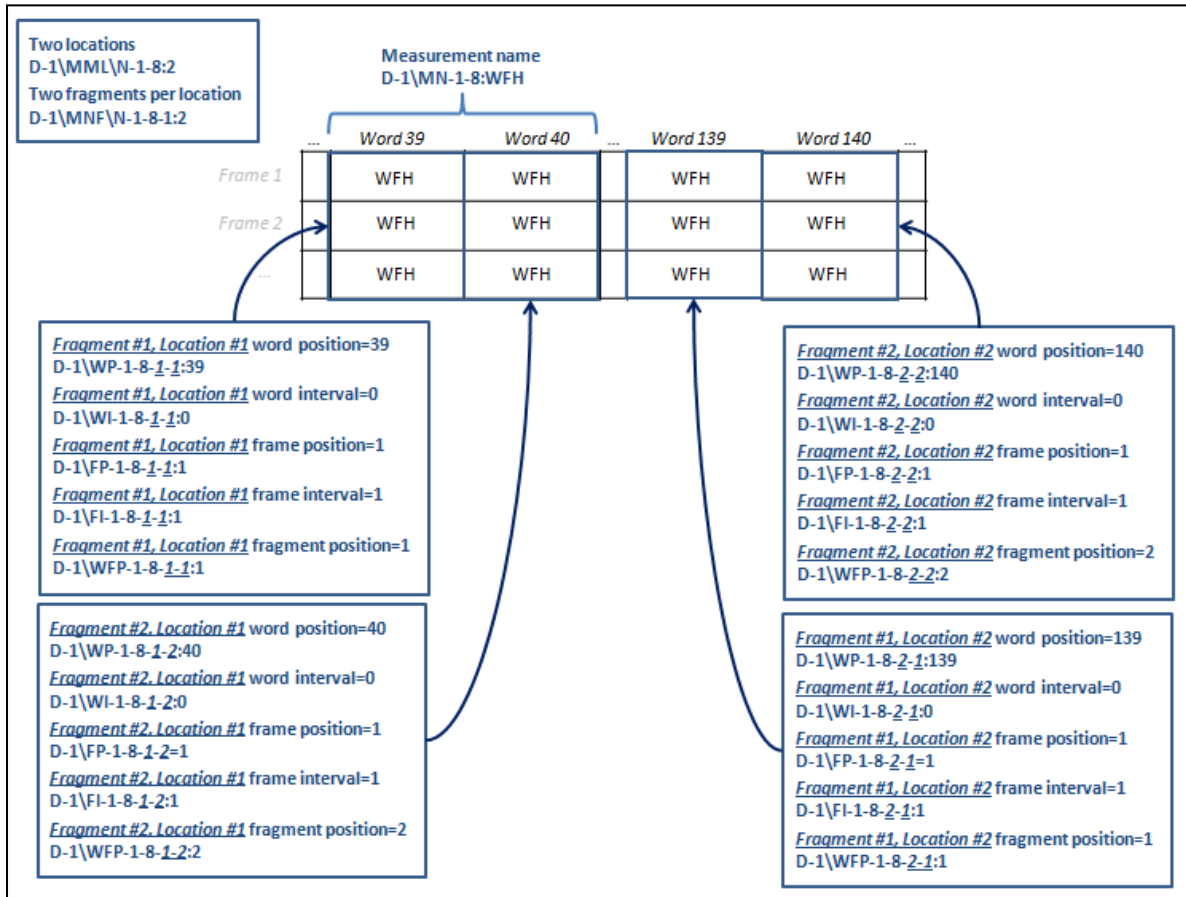

Figure 5-22. Minor Frame Fragmented and Supercommutated Measurement (Two Locations)

**D-1\MN-1-8:WFH;**  
**D-1\MN1-1-8:DE;**  
**D-1\MN2-1-8:D;**  
**D-1\MN3-1-8:D;**  
**D-1\LT-1-8:WDFR;**

- (1) Two Locations. There are two locations of this measurement.  
**D-1\MML\N-1-8:2;**
- (2) Two Fragments. Each measurement location consists of two fragments. This is displayed in Figure 5-23.

**D-1\MNF\N-1-8-1:2;**

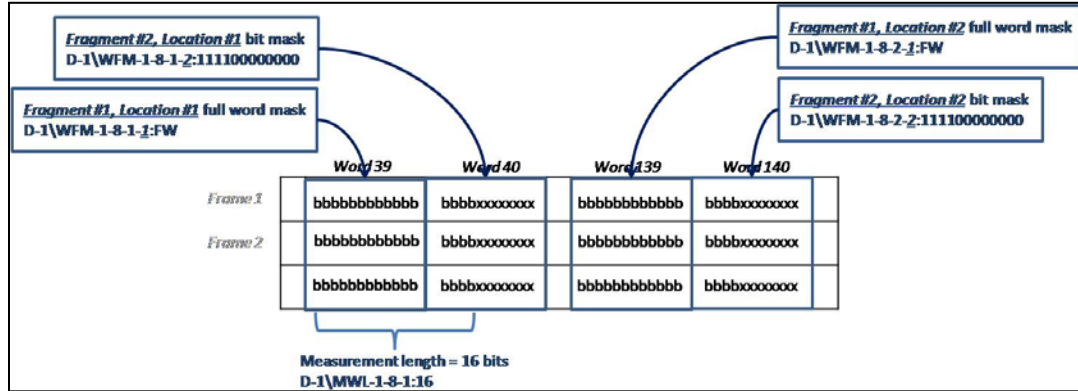

Figure 5-23. Minor Frame Fragmented and Supercommutated Measurement (Two Fragments in Each Location)

- (3) First location definition, first fragment. The first fragment is in word position 39, in every frame.  
**D-1\WP-1-8-1-1:39;**  
**D-1\WI-1-8-1-1:0;**  
**D-1\FP-1-8-1-1:1;**  
**D-1\FI-1-8-1-1:1;**  
**D-1\WFM-1-8-1-1:FW;**
- (4) Fragment transfer order. Defaults to the P-Group measurement transfer order entry.  
**D-1\WFT-1-8-1-1:D;**
- (5) Most significant fragment.  
**D-1\WFP-1-8-1-1:1;**
- (6) First location definition, second fragment. The second fragment is in word position 40, in every frame.  
**D-1\WP-1-8-1-2:40;**  
**D-1\WI-1-8-1-2:0;**  
**D-1\FP-1-8-1-2:1;**  
**D-1\FI-1-8-1-2:1;**
- (7) Most significant four bits. The most significant four bits are used.  
**D-1\WFM-1-8-1-2:111100000000;**  
**D-1\WFT-1-8-1-2:D;**
- (8) Least significant fragment.  
**D-1\WFP-1-8-1-2:2;**
- (9) Second location definition, first fragment. The first fragment is in word position 139, in every frame.  
**D-1\WP-1-8-2-1:139;**  
**D-1\WI-1-8-2-1:0;**  
**D-1\FP-1-8-2-1:1;**  
**D-1\FI-1-8-2-1:1;**

**D-1\WFM-1-8-2-1:FW;**

- (10) Fragment transfer order. Defaults to the P-Group measurement transfer order entry.

**D-1\WFT-1-8-2-1:D;**

- (11) Most significant fragment.

**D-1\WFP-1-8-2-1:1;**

- (12) Second location definition, second fragment. The second fragment is in word position 140, in every frame.

**D-1\WP-1-8-2-2:140;**

**D-1\WI-1-8-2-2:0;**

**D-1\FP-1-8-2-2:1;**

**D-1\FI-1-8-2-2:1;**

- (13) Most Significant four bits. The most significant four bits are used.

**D-1\WFM-1-8-2-2:111100000000;**

**D-1\WFT-1-8-2-2:D;**

- (14) Least significant fragment.

**D-1\WFP-1-8-2-2:2;**

The XML snippet for the example above is shown in [Figure 5-24](#).

```

<TmatsD:Measurement Name="WFH">
  <TmatsD:Parity>Default</TmatsD:Parity>
  <TmatsD:ParityTransferOrder>Default</TmatsD:ParityTransferOrder>
  <TmatsD:MeasurementTransferOrder>Default</TmatsD:MeasurementTransferOrder>
  <TmatsD:LocationType>Word and Frame</TmatsD:LocationType>
  <TmatsD:WordAndFrame>
    <TmatsD:MeasurementLocation>
      <TmatsD:MeasurementFragments>
        <TmatsD:FragmentPosition>1</TmatsD:FragmentPosition>
        <TmatsD:FragmentTransferOrder>Default</TmatsD:FragmentTransferOrder>
        <TmatsD:StartWord>39</TmatsD:StartWord>
        <TmatsD:WordInterval>0</TmatsD:WordInterval>
        <TmatsD:StartFrame>1</TmatsD:StartFrame>
        <TmatsD:FrameInterval>1</TmatsD:FrameInterval>
        <TmatsD:BitMask>Full Word</TmatsD:BitMask>
      </TmatsD:MeasurementFragments>
    </TmatsD:MeasurementLocation>
    <TmatsD:MeasurementLocation>
      <TmatsD:MeasurementFragments>
        <TmatsD:FragmentPosition>2</TmatsD:FragmentPosition>
        <TmatsD:FragmentTransferOrder>Default</TmatsD:FragmentTransferOrder>
        <TmatsD:StartWord>40</TmatsD:StartWord>
        <TmatsD:WordInterval>0</TmatsD:WordInterval>
        <TmatsD:StartFrame>1</TmatsD:StartFrame>
        <TmatsD:FrameInterval>1</TmatsD:FrameInterval>
        <TmatsD:BitMask>111100000000</TmatsD:BitMask>
      </TmatsD:MeasurementFragments>
    </TmatsD:MeasurementLocation>
  </TmatsD:WordAndFrame>
</TmatsD:Measurement>

```

Figure 5-24. Minor Frame Fragmented and Supercommutated Measurement Example XML

## 5.2 Concatenation Examples

### 5.2.1 Example 1

For our first example, let's assume that we have a PCM format that has a common word length of 12. In order to sample a 16-bit data word, the sample must use two 12-bit words in the

PCM format. Typically, the data will be msb aligned so that the first data word contains 12 data bits and the second data word contains four data bits. This example is illustrated in [Figure 5-25](#).

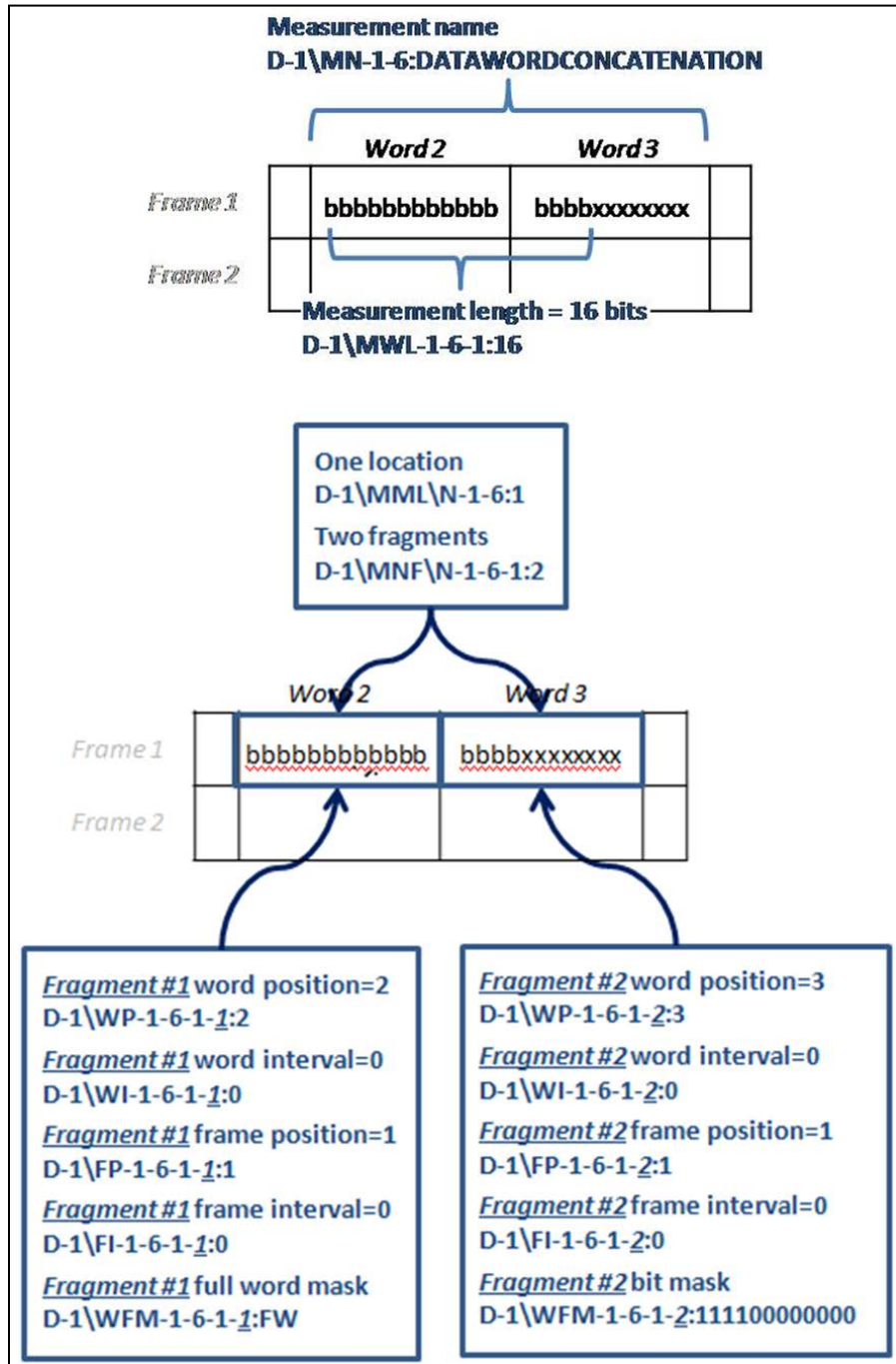

Figure 5-25. Concatenation Example 1: Two Words

The following snippet of TMATS describes an example of the concatenation type of measurement. The two fragments are located in word 2, frame 1 and word 3, frame 1 in the PCM format.

- a. Measurement Name. This TMATS attribute of measurement 6 in measurement list 1 of data link 1 defines the measurement name “DATAWORDCONCATENATION” for this example.

**D-1\MN-1-6: DATAWORDCONCATENATION;**

- (1) Parity is disabled for this measurement.

**D-1\MN1-1-6:NO;**

- (2) The parity transfer order is default.

**D-1\MN2-1-6:D;**

- (3) The measurement transfer order is msb first.

**D-1\MN3-1-6:M;**

- b. Measurement locations. The measurement locations in the PCM format are described using the recommended word and frame method.

**D-1\LT-1-6:WDFR;**

- (1) There is one measurement location definition for this measurement in the TMATS file. A measurement location definition is used to describe a set of words that are linked by word and frame intervals. Since the value is 1, there will be exactly one measurement location definition. The index for this definition will be 1-6-1.

**D-1\MML\N-1-6:1;**

- (2) In the measurement location definition, the measurement is broken into two fragments. Each fragment contains part of the measurement. The two fragments are described by indicating the word position, frame position, word increment, and frame increment for each word in the fragment.

**D-1\MNF\N-1-6-1:2;**

- c. First Fragment. The first fragment is sampled at word 2.

**D-1\WP-1-6-1-1:2;**

- (1) The first fragment has a word interval of 0. This means it only occurs once in the minor frame.

**D-1\WI-1-6-1-1:0;**

- (2) The first fragment is sampled at frame 1.

**D-1\FP-1-6-1-1:1;**

- (3) The first fragment has a frame interval of 0. This means it occurs in one minor frame.

**D-1\FI-1-6-1-1:0;**

- (4) All 12 bits in the first fragment are included so the mask is set to FW the TMATS enumeration for full word.

**D-1\WFM-1-6-1-1:FW;**

- (5) Fragment transfer order is msb first.

**D-1\WFT-1-6-1-1:M;**

- (6) This fragment is the first of the 2 segments in the measurement.

**D-1\WFP-1-6-1-1:1;**

- d. Second Fragment. The second fragment has a word number of 3 in the minor frame. Notice how the fragment index has changed from 1 to 2.

**D-1\WP-1-6-1-2:3;**

- (1) The second fragment has a word interval of 0.

**D-1\WI-1-6-1-2:0;**

- (2) The second fragment is sampled at frame 1.

**D-1\FP-1-6-1-2:1;**

- (3) The second fragment has a frame interval of 0.

**D-1\FI-1-6-1-2:0;**

- (4) The bit mask for fragment number 2 is 0xF00 which means keep the 4 most significant bits and discard the other 8 bits.

**D-1\WFM-1-6-1-2:111100000000;**

- (5) Fragment transfer order is msb first.

**D-1\WFT-1-6-1-2:M;**

- (6) This fragment is the second of the 2 segments in the measurement.

**D-1\WFP-1-6-1-2:2;**

The XML snippet for the example above is shown in [Figure 5-26](#).

```
<TmatsD:Measurement Name="DATAWORDCONCATENATION">
  <TmatsD:Parity>None</TmatsD:Parity>
  <TmatsD:ParityTransferOrder>Default</TmatsD:ParityTransferOrder>
  <TmatsD:MeasurementTransferOrder>MSB First</TmatsD:MeasurementTransferOrder>
  <TmatsD:LocationType>Word and Frame</TmatsD:LocationType>
  <TmatsD:WordAndFrame>
    <TmatsD:MeasurementLocation>
      <TmatsD:MeasurementFragments>
        <TmatsD:FragmentPosition>1</TmatsD:FragmentPosition>
        <TmatsD:FragmentTransferOrder>MSB First</TmatsD:FragmentTransferOrder>
        <TmatsD:StartWord>2</TmatsD:StartWord>
        <TmatsD:WordInterval>0</TmatsD:WordInterval>
        <TmatsD:StartFrame>1</TmatsD:StartFrame>
        <TmatsD:FrameInterval>0</TmatsD:FrameInterval>
        <TmatsD:BitMask>Full Word</TmatsD:BitMask>
      </TmatsD:MeasurementFragments>
    </TmatsD:MeasurementLocation>
    <TmatsD:MeasurementFragments>
      <TmatsD:FragmentPosition>2</TmatsD:FragmentPosition>
      <TmatsD:FragmentTransferOrder>MSB First</TmatsD:FragmentTransferOrder>
      <TmatsD:StartWord>3</TmatsD:StartWord>
      <TmatsD:WordInterval>0</TmatsD:WordInterval>
      <TmatsD:StartFrame>1</TmatsD:StartFrame>
      <TmatsD:FrameInterval>0</TmatsD:FrameInterval>
      <TmatsD:BitMask>111100000000</TmatsD:BitMask>
    </TmatsD:MeasurementFragments>
  </TmatsD:WordAndFrame>
</TmatsD:Measurement>
```

Figure 5-26. Concatenation Example #1 XML



- e. Data Conversion. Each PCM measurement in TMATS has a set of D-Group attributes and an optional set of C-Group attributes. If the C-Group attributes are not included, then the measurement is assumed to be a collection of bits. The DCN attribute is the beginning of the C-Group entries for this measurement. This attribute in the C-Group allows the C-Group entries to be linked to the corresponding D-Group entries for the measurement by the measurement name (**D-x\MN-y-n**), which is DATAWORDCONCATENATION.

**C-6\DCN: DATAWORDCONCATENATION;**

- (1) The description of the measurement is in human-readable text.

**C-6\MN1:16 Bit Concatenation of 2 Data Words;**

- (2) The source data link type is PCM.

**C-6\MN4:PCM;**

- (3) The binary format of this measurement is unsigned binary.

**C-6\BFM:UNS;**

- (4) The data conversion type for this measurement is none. There is no data conversion for this measurement, therefore we use NON.

**C-6\DCT:NON;**

The XML snippet for the example above is shown in [Figure 5-27](#).

```
<TmatsG:DataConversionAttributes TmatsCommon:TmatsVersion="106-13">
  <TmatsC:Measurement Name="DATAWORDCONCATENATION">
    <TmatsC:Measurand>
      <TmatsC:Description>
        16 Bit Concatenation of 2 Data Words</TmatsC:Description>
      <TmatsC:LinkType>PCM</TmatsC:LinkType>
    </TmatsC:Measurand>
    <TmatsC:TelemetryValueDefinition>
      <TmatsC:BinaryFormat>Unsigned Binary</TmatsC:BinaryFormat>
    </TmatsC:TelemetryValueDefinition>
    <TmatsC:DataConversion Type="None" />
  </TmatsC:Measurement>
</TmatsG:DataConversionAttributes>
```

Figure 5-27. Data Conversion Example #1 XML

### 5.2.2 Example 2

For our second example, consider a case where a concatenation is spread across three different words; six bits come from the first word, 12 bits from the second word, and six bits come from the third word. This example is illustrated in [Figure 5-28](#).

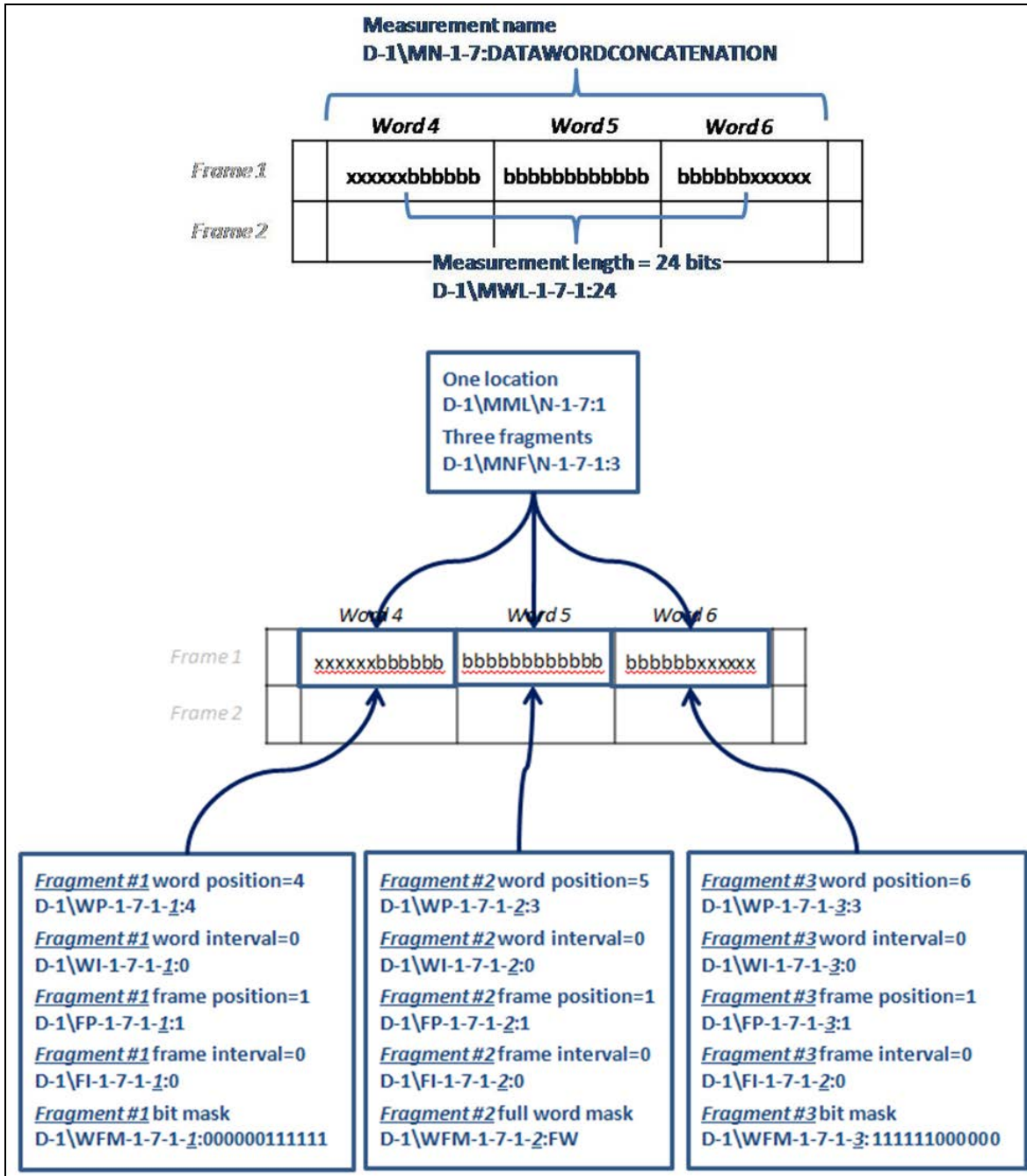

Figure 5-28. Concatenation Example 2: Three Words

**D-1\MN-1-7:MASKEDWORDCONCATENATION;**  
**D-1\MN1-1-7:NO;**  
**D-1\MN2-1-7:D;**  
**D-1\MN3-1-7:M;**  
**D-1\LT-1-7:WDFR;**  
**D-1\MML\N-1-7:1;**  
**D-1\MNF\N-1-7-1:3;**  
**D-1\WP-1-7-1-1:4;**

**D-1\WI-1-7-1-1:0;**  
**D-1\FP-1-7-1-1:1;**  
**D-1\FI-1-7-1-1:0;**

The three fragment masks are described below.

- a. First fragment. For the first fragment, the mask is 0x03F.  
**D-1\WFM-1-7-1-1:000000111111;**  
**D-1\WFT-1-7-1-1:M;**  
**D-1\WFP-1-7-1-1:1;**  
**D-1\WP-1-7-1-2:5;**  
**D-1\WI-1-7-1-2:0;**  
**D-1\FP-1-7-1-2:1;**  
**D-1\FI-1-7-1-2:0;**
- b. Second fragment. For the second fragment, the mask is 0xFFF or FW, the TMATS enumeration for Full Word.  
**D-1\WFM-1-7-1-2:FW;**  
**D-1\WFT-1-7-1-2:M;**  
**D-1\WFP-1-7-1-2:2;**  
**D-1\WP-1-7-1-3:6;**  
**D-1\WI-1-7-1-3:0;**  
**D-1\FP-1-7-1-3:1;**  
**D-1\FI-1-7-1-3:0;**
- c. Third fragment. For the third fragment, the mask is 0xFC0.  
**D-1\WFM-1-7-1-3:111111000000;**  
**D-1\WFT-1-7-1-3:M;**  
**D-1\WFP-1-7-1-3:3;**

The XML snippet for the example above is shown in [Figure 5-29](#).

```

<TmatsD:Measurement Name="MASKEDWORDCONCATENATION">
  <TmatsD:Parity>None</TmatsD:Parity>
  <TmatsD:ParityTransferOrder>Default</TmatsD:ParityTransferOrder>
  <TmatsD:MeasurementTransferOrder>MSB First</TmatsD:MeasurementTransferOrder>
  <TmatsD:LocationType>Word and Frame</TmatsD:LocationType>
  <TmatsD:WordAndFrame>
    <TmatsD:MeasurementLocation>
      <TmatsD:MeasurementFragments>
        <TmatsD:FragmentPosition>1</TmatsD:FragmentPosition>
        <TmatsD:FragmentTransferOrder>MSB First</TmatsD:FragmentTransferOrder>
        <TmatsD:StartWord>4</TmatsD:StartWord>
        <TmatsD:WordInterval>0</TmatsD:WordInterval>
        <TmatsD:StartFrame>1</TmatsD:StartFrame>
        <TmatsD:FrameInterval>0</TmatsD:FrameInterval>
        <TmatsD:BitMask>000000111111</TmatsD:BitMask>
      </TmatsD:MeasurementFragments>
      <TmatsD:MeasurementFragments>
        <TmatsD:FragmentPosition>2</TmatsD:FragmentPosition>
        <TmatsD:FragmentTransferOrder>MSB First</TmatsD:FragmentTransferOrder>
        <TmatsD:StartWord>5</TmatsD:StartWord>
        <TmatsD:WordInterval>0</TmatsD:WordInterval>
        <TmatsD:StartFrame>1</TmatsD:StartFrame>
        <TmatsD:FrameInterval>0</TmatsD:FrameInterval>
        <TmatsD:BitMask>Full Word</TmatsD:BitMask>
      </TmatsD:MeasurementFragments>
      <TmatsD:MeasurementFragments>
        <TmatsD:FragmentPosition>3</TmatsD:FragmentPosition>
        <TmatsD:FragmentTransferOrder>MSB First</TmatsD:FragmentTransferOrder>
        <TmatsD:StartWord>6</TmatsD:StartWord>
        <TmatsD:WordInterval>0</TmatsD:WordInterval>
        <TmatsD:StartFrame>1</TmatsD:StartFrame>
        <TmatsD:FrameInterval>0</TmatsD:FrameInterval>
        <TmatsD:BitMask>111111000000</TmatsD:BitMask>
      </TmatsD:MeasurementFragments>
    </TmatsD:MeasurementLocation>
  </TmatsD:WordAndFrame>
</TmatsD:Measurement>

```

Figure 5-29. Concatenation Example #2 XML

- d. **Data Conversion.** The following attributes are part of the C-Group. The C-Group attributes are optional. If the C-Group attributes are not included then the measurement is assumed to be a collection of bits. These attributes describe the data conversion for this measurement. The C-Group entries are linked by the C-7\DCN attribute to the D-Group entries by the D-1\MN-1-7 attribute.

**C-7\DCN:MASKEDWORDCONCATENATION;**  
**C-7\MN1:MaskedWordConcatenation;**  
**C-7\MN4:PCM;**  
**C-7\BFM:UNS;**  
**C-7\DCT:NON;**

The XML snippet for the example above is shown in [Figure 5-30](#).

```

<TmatsG:DataConversionAttributes TmatsCommon:TmatsVersion="106-13">
  <TmatsC:Measurement Name="MASKEDWORDCONCATENATION">
    <TmatsC:Measurand>
      <TmatsC:Description>MaskedWordConcatenation</TmatsC:Description>
      <TmatsC:LinkType>PCM</TmatsC:LinkType>
    </TmatsC:Measurand>
    <TmatsC:TelemetryValueDefinition>
      <TmatsC:BinaryFormat>Unsigned Binary</TmatsC:BinaryFormat>
    </TmatsC:TelemetryValueDefinition>
    <TmatsC:DataConversion Type="None" />
  </TmatsC:Measurement>
</TmatsG:DataConversionAttributes>

```

Figure 5-30. Data Conversion Example #2 XML

### 5.2.3 Summary of Concatenation Examples.

Note that both of the above examples show the concatenations using contiguous regions of bits. This is the most common usage of the bit masks in concatenations, but it is not required. A concatenation can be created by selecting any set of bits from one or more data words. For example, this could be used to create a measurement that contains status bits from multiple data words.

### 5.3 Example of an Unevenly Spaced Measurement

The following is an example of how to describe measurements that are not evenly spaced throughout the major frame, meaning they are not sampled in equal intervals. In [Figure 5-31](#) the parameter UNEV is sampled five times, but with uneven intervals.

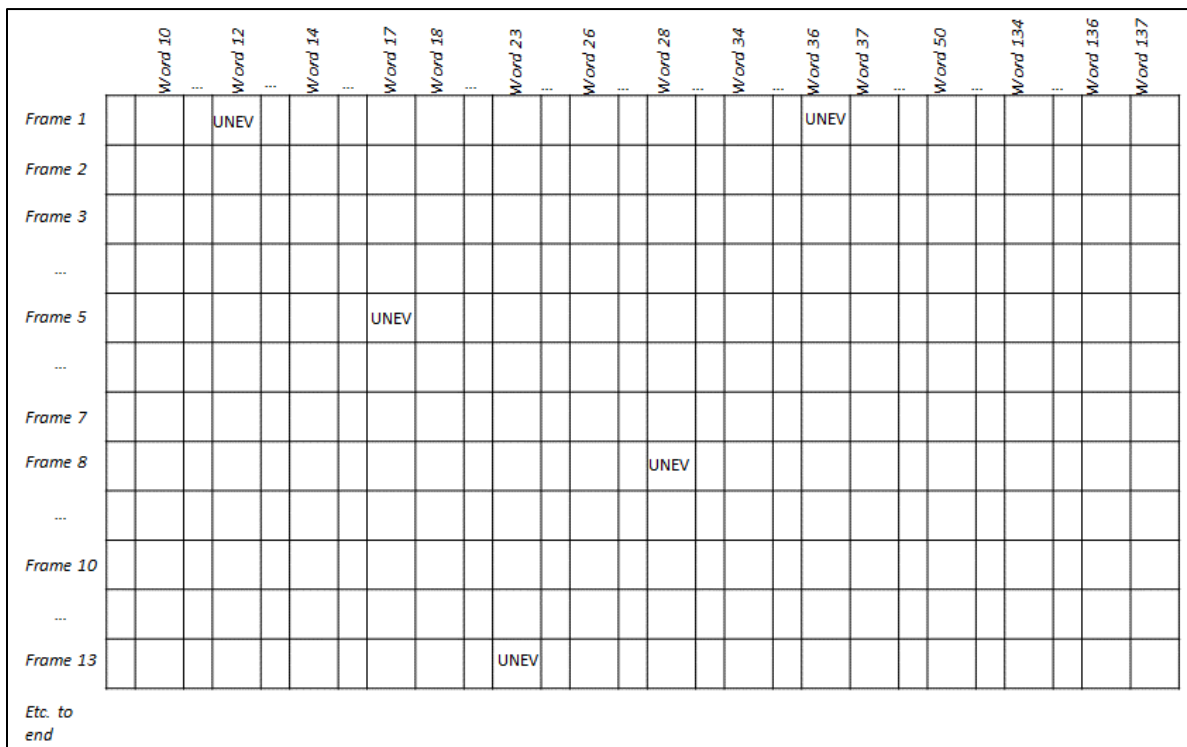

Figure 5-31. Unevenly Spaced Measurements

- a. Indicates that there is a total of five measurement locations for parameter UNEV.

**D-1\MN-1-1:UNEV;**  
**D-1\MN1-1-1:DE;**  
**D-1\MN2-1-1:D;**  
**D-1\MN3-1-1:M;**  
**D-1\LT-1-1:WDFR;**  
**D-1\MML\N-1-1:5;**

- b. Each measurement location must be described. The first parameter location:

**D-1\MNF\N-1-1-1:1;**  
**D-1\WP-1-1-1-1:12;**  
**D-1\WI-1-1-1-1:0;**  
**D-1\FP-1-1-1-1:1;**  
**D-1\FI-1-1-1-1:0;**  
**D-1\WFM-1-1-1-1:FW;**  
**D-1\WFP-1-1-1-1:1;**

- c. The second parameter location:

**D-1\MNF\N-1-1-2:1;**  
**D-1\WP-1-1-2-1:36;**  
**D-1\WI-1-1-2-1:0;**  
**D-1\FP-1-1-2-1:1;**  
**D-1\FI-1-1-2-1:0;**  
**D-1\WFM-1-1-2-1:FW;**  
**D-1\WFP-1-1-2-1:1;**

- d. The third parameter location:

**D-1\MNF\N-1-1-3:1;**  
**D-1\WP-1-1-3-1:17;**  
**D-1\WI-1-1-3-1:0;**  
**D-1\FP-1-1-3-1:5;**  
**D-1\FI-1-1-3-1:0;**  
**D-1\WFM-1-1-3-1:FW;**  
**D-1\WFP-1-1-3-1:1;**

- e. The fourth parameter location:

**D-1\MNF\N-1-1-4:1;**  
**D-1\WP-1-1-4-1:28;**  
**D-1\WI-1-1-4-1:0;**  
**D-1\FP-1-1-4-1:8;**  
**D-1\FI-1-1-4-1:0;**  
**D-1\WFM-1-1-4-1:FW;**  
**D-1\WFP-1-1-4-1:1;**

- f. The fifth parameter location:

**D-1\MNF\N-1-1-5:1;**  
**D-1\WP-1-1-5-1:23;**  
**D-1\WI-1-1-5-1:0;**  
**D-1\FP-1-1-5-1:13;**

**D-1\FI-1-1-5-1:0;**  
**D-1\WFM-1-1-5-1:FW;**

The XML snippet for the example above is shown in [Figure 5-32](#).

```

<TmatsD:Measurement Name="UNEV">
  <TmatsD:Parity>Default</TmatsD:Parity>
  <TmatsD:ParityTransferOrder>Default</TmatsD:ParityTransferOrder>
  <TmatsD:MeasurementTransferOrder>Default</TmatsD:MeasurementTransferOrder>
  <TmatsD:LocationType>Word and Frame</TmatsD:LocationType>
  <TmatsD:WordAndFrame>
    <TmatsD:MeasurementLocation>
      <TmatsD:MeasurementFragments>
        <TmatsD:FragmentPosition>1</TmatsD:FragmentPosition>
        <TmatsD:FragmentTransferOrder>Default</TmatsD:FragmentTransferOrder>
        <TmatsD:StartWord>12</TmatsD:StartWord>
        <TmatsD:WordInterval>0</TmatsD:WordInterval>
        <TmatsD:StartFrame>1</TmatsD:StartFrame>
        <TmatsD:FrameInterval>0</TmatsD:FrameInterval>
        <TmatsD:BitMask>Full Word</TmatsD:BitMask>
      </TmatsD:MeasurementFragments>
    </TmatsD:MeasurementLocation>
    <TmatsD:MeasurementLocation>
      <TmatsD:MeasurementFragments>
        <TmatsD:FragmentPosition>1</TmatsD:FragmentPosition>
        <TmatsD:FragmentTransferOrder>Default</TmatsD:FragmentTransferOrder>
        <TmatsD:StartWord>36</TmatsD:StartWord>
        <TmatsD:WordInterval>0</TmatsD:WordInterval>
        <TmatsD:StartFrame>1</TmatsD:StartFrame>
        <TmatsD:FrameInterval>0</TmatsD:FrameInterval>
        <TmatsD:BitMask>Full Word</TmatsD:BitMask>
      </TmatsD:MeasurementFragments>
    </TmatsD:MeasurementLocation>
    <TmatsD:MeasurementLocation>
      <TmatsD:MeasurementFragments>
        <TmatsD:FragmentPosition>1</TmatsD:FragmentPosition>
        <TmatsD:FragmentTransferOrder>Default</TmatsD:FragmentTransferOrder>
        <TmatsD:StartWord>17</TmatsD:StartWord>
        <TmatsD:WordInterval>0</TmatsD:WordInterval>
        <TmatsD:StartFrame>5</TmatsD:StartFrame>
        <TmatsD:FrameInterval>0</TmatsD:FrameInterval>
        <TmatsD:BitMask>Full Word</TmatsD:BitMask>
      </TmatsD:MeasurementFragments>
    </TmatsD:MeasurementLocation>
    <TmatsD:MeasurementLocation>
      <TmatsD:MeasurementFragments>
        <TmatsD:FragmentPosition>1</TmatsD:FragmentPosition>
        <TmatsD:FragmentTransferOrder>Default</TmatsD:FragmentTransferOrder>
        <TmatsD:StartWord>28</TmatsD:StartWord>
        <TmatsD:WordInterval>0</TmatsD:WordInterval>
        <TmatsD:StartFrame>8</TmatsD:StartFrame>
        <TmatsD:FrameInterval>0</TmatsD:FrameInterval>
        <TmatsD:BitMask>Full Word</TmatsD:BitMask>
      </TmatsD:MeasurementFragments>
    </TmatsD:MeasurementLocation>
    <TmatsD:MeasurementLocation>
      <TmatsD:MeasurementFragments>
        <TmatsD:FragmentPosition>1</TmatsD:FragmentPosition>
        <TmatsD:FragmentTransferOrder>Default</TmatsD:FragmentTransferOrder>
        <TmatsD:StartWord>23</TmatsD:StartWord>
        <TmatsD:WordInterval>0</TmatsD:WordInterval>
        <TmatsD:StartFrame>13</TmatsD:StartFrame>
        <TmatsD:FrameInterval>0</TmatsD:FrameInterval>
        <TmatsD:BitMask>Full Word</TmatsD:BitMask>
      </TmatsD:MeasurementFragments>
    </TmatsD:MeasurementLocation>
  </TmatsD:WordAndFrame>
</TmatsD:Measurement>

```

Figure 5-32. Unevenly Spaced Measurement Example XML



## 5.4 Examples for Setting up Transmission Attributes

The T-Group defines data transmitted via an RF link – the source of the data stream. Much of the information in this section is commentary in nature, but could be used to configure the antenna and receiver subsystems. The T-Group is tied to the G-Group via the data source ID, which in this example is “RF\_DATA\_SOURCE.”

The T-Group contains two distinct sections. The first section describes the attributes of the RF source, which is the transmitter. The second section deals with the information necessary to set up the ground station in order to receive the signal from the transmitter.

### 5.4.1 Source RF Attributes

In order to telemeter the information defined in earlier sections, such as Tire Pressure 1, a transmitter and appropriate antenna must be selected for placement on the test vehicle. The transmitter must have the appropriate characteristics to handle the structure of the PCM matrix containing the data in order to accurately transmit the data to the ground station antenna, receiver, and recording device.

Some of the basic characteristics of the PCM matrix affecting transmitter selection are the total number of measurements and the rate at which each measurement must be sampled to accurately convey the information to the ground. These characteristics determine the clock speed or the bit rate of the SST, which is expressed in bps, thousands of bits per second, or Mbps; someone will no doubt want gigabits per second soon! The RCC 119 Telemetry Applications Handbook<sup>9</sup> contains guidelines for determining PCM characteristics, which must be done before a transmitter is selected.

The transmitter must be designed to operate at the required data rate on a frequency authorized for the particular location and ground station to be used. The transmitter output power requirement must be determined based on the range between vehicle and ground station, as well as the bit rate and modulation scheme. The TMATS file will aggregate all this information so that it may be distributed in a common format that all users will understand.

For this example, it has been determined that a bit rate of 2.0 Mbps is necessary to transmit the data, and a frequency of 2251.5 MHz has been assigned.

- a. Data Source ID. The data source ID “RF\_DATA\_SOURCE” has been assigned to the TM matrix in this example. This is the link from the G-Group to the T-Group that will tie the data and the transmitter characteristics together. In the simplest example **T-1\ID:** and **G\DSI-1:** must match. A numeric index must be assigned to the “T” attribute, which in this case will be 1 to indicate this is the first transmitter or link to be defined. In this example, it is the only one. The complete DATA SOURCE ID attribute is:

**T-1\ID:RF\_DATA\_SOURCE;**

- b. Transmitter ID. A Model ST405S transmitter manufactured by ACME RF meets the requirements for this application. This is a 5-watt transmitter and has been determined to be the power required for this RF link by use of the Link Analysis procedure, which is

---

<sup>9</sup> Range Commanders Council. *Telemetry Applications Handbook*. RCC 119-06. May 2006. May be superseded by update. Retrieved 16 June 2015. Available at [http://www.wsmr.army.mil/RCCsite/Documents/119-06\\_Telemetry\\_Applications\\_Handbook/](http://www.wsmr.army.mil/RCCsite/Documents/119-06_Telemetry_Applications_Handbook/).

defined in great detail in RCC Document 119, Section 2.10. This identification information is assigned to the TRANSMITTER ID attribute T-x\TID.

**T-1\TID:ST405S;**

The transmitter may be further identified by adding the serial number to this attribute. This field can contain any information deemed necessary to identify the transmitter up to the maximum field length allowed for this attribute.

**T-1\TID: ST405S\_977;**

- c. Frequency. This transmitter is programmable in frequency, which allows two options: It can either be programmed to a fixed frequency such as 2251.5 MHz, or programmed remotely and changed as required for a particular test. The frequency attribute specifies the option to be used. A “P” is entered if the remote programming option is implemented; otherwise a discrete frequency is entered. In this example, the frequency will be fixed, so T-x\RF1 becomes:

**T-1\RF1:2251.5;**

- d. PCM Code and Bit Rate. The modulation type, PCM code, and bit rate must be known before the RF and data bandwidth can be determined. This information also helps determine the carrier deviation. The code and bit rate specified in the P-Group are:

**P-1\D1:NRZ-L;**

**P-1\D2:2000000;**

- e. RF Bandwidth. The most common modulation type is direct frequency modulation (FM) on the transmitter carrier (defined below with attribute T-1\RF4). Referring to the extensive guidance in RCC 119, paragraph 2.2, the RF bandwidth, the data bandwidth, and the total transmitter carrier deviation may be determined to optimize the signal-to-noise ratio and the BER. Note: 2.0 MHz is the total RF bandwidth of the 2.0 Mbps NRZ-L modulated signal at the -60-dB point of the waveform.

**T-1\RF2:2.0;**

- f. Data Bandwidth. 750 kilohertz (kHz) is the bandwidth of the baseband data signal at the -3 dB points.

**T-1\RF3:750;**

- g. Modulation Type. The NRZ-L code will be applied directly to the selected transmitter, which is a frequency-modulated RF carrier type. The modulating code is specified as FM.

**T-1\RF4: FM;**

- h. Total Carrier Modulation. For an FM transmitter, this attribute specifies the total peak-to-peak deviation of the carrier, expressed in kHz. For a phase-modulated transmitter this attribute would specify the total peak-to-peak phase angle expressed in radians.

**T-1\RF5:750;**

- i. Power (Radiated). With a 5-watt transmitter and a 3-dB loss in the antenna system, the actual radiated power is 2.5 watts. Other losses to consider for this attribute include the loss in the coax between the transmitter and the antenna, and any other components in the coax line such as multi-couplers and filters.

**T-1\RF6: 2.5;**

- j. Number of Subcarriers. There are no subcarriers on this system. The data is directly applied to the transmitter input.  
**T-1\SCO\N: NO;**
- k. Attributes not used. The following attributes are not used and are not required to be present since there are no subcarriers used in the system. If the previous attribute had specified a number of subcarriers (such as T-1\SCO\N:2;), then there would be two additional entries for each subcarrier. The following four attributes demonstrate how these would be defined. A list of standard subcarrier channel numbers and their respective frequencies is found in RCC 106, Chapter 3.<sup>10</sup> As an example using channel 12 and channel 15, the following four attributes would be required. The generic form of these attributes is: T-x\SCO1-n and T-x\SCO2-n.
- (1) Subcarrier Number. The first subcarrier is channel number 12.  
**T-1\SCO1-1:12;**
  - (2) Modulation Index. The modulation index for this channel is 0.85.  
**T-1\SCO2-1:0.85;**
  - (3) Subcarrier Number. The second subcarrier is channel number 15.  
**T-1\SCO1-2:15;**
  - (4) Modulation Index. The modulation index for this channel is 0.98.  
**T-1\SCO2-2:0.98;**
- l. Modulation Nonlinearity. The modulation process is an inherently non-linear process given the types of electronic components (varactors and voltage-controlled oscillators) used in TM transmitters. Poor modulation linearity can increase the BER of a TM link and the quality of the received data. With follow-on generations of more stable frequency sources, new synthesis and modulation techniques, and digital transmitters, nonlinearity seldom affects the accuracy of the present-day transmitter and the signal it conveys. This attribute is almost never specified here, and is often not specified on a transmitter data sheet. Test methods to measure this parameter may be found in RCC 118 Volume 1,<sup>11</sup> Section 5.5. The attribute is included here for completeness, and is expressed as a percent.  
**T-1\RF7:2.0;**
- m. Premodulation Filter. The next three attributes define the filter applied to the modulating signal before the transmitter. The pre-modulation filter is used to reduce the baseband and RF bandwidth of the PCM signal. Typically, the filter is chosen to be 0.7 times the bit rate. This value will reduce any spurious emissions in the modulating signal due to higher-frequency components while having no effect on the BER performance of the link. Sometimes the frequency response of the transmitter is all that is necessary to

---

<sup>10</sup> Range Commanders Council. "Frequency Division Multiplexing Telemetry Standards," in *Telemetry Standards*. IRIG 106-15. April 2015. Available at [http://www.wsmr.army.mil/RCCsite/Documents/106-15\\_Telemetry\\_Standards/chapter3.pdf](http://www.wsmr.army.mil/RCCsite/Documents/106-15_Telemetry_Standards/chapter3.pdf).

<sup>11</sup> Range Commanders Council. *Test Methods for Telemetry Systems and Subsystems, Volume 1. Test Methods for Vehicle Telemetry Systems*. RCC 118-12 Volume 1. May 2012. May be superseded by update. Retrieved 15 June 2015. Available at [http://www.wsmr.army.mil/RCCsite/Documents/118-12\\_Vol\\_1-Test\\_Methods\\_for\\_Vehicle\\_Telemetry\\_Systems/](http://www.wsmr.army.mil/RCCsite/Documents/118-12_Vol_1-Test_Methods_for_Vehicle_Telemetry_Systems/).

perform this function, and the filter is typically built into a transmitter designed for digital systems.

- (1) Bandwidth. In this example, specify 0.7 times the 2.0-Mbps bit rate, or 1400 kHz at the  $-3$  dB point.

**T-1\PMF1:1400;**

- (2) Slope. The roll-off slope of the pre-modulation filter may be specified here in dB/octave.

**T-1\PMF2:6.0;**

- (3) Type. The type of pre-modulation filter, either constant amplitude or constant delay, goes here. If it's neither specify "other" as OT.

**T1-\PMF3:CA;**

- n. Transmit Antenna. The next three attributes provide information on the transmit antenna and manufacturer.

- (1) Transmit Antenna Type. The type of antenna.

**T-1\AN1: Blade;**

- (2) Transmit Polarization. The polarization of the antenna. Choices are Right Hand Circular, Left Hand Circular, or Linear. These are represented by the TMATS enumerations RHCP, LHCP, and LIN.

**T-1\AN2: LIN;**

- (3) Antenna Location. The location of the antenna on the test vehicle is important when considering the flight path and type of maneuvers to be conducted.

**T-1\AN3: BELLY;**

- o. Antenna Patterns. The next attribute refers to a document that would provide details of the antenna pattern. This is followed with a POC for additional information regarding details of the antenna system.

- p. Document. A reference to the document or the drawing that specifies the antenna characteristics.

**T-1\AP:Dwg A2345-1 ;**

- q. Point Of Contact.

- (1) Name.

**T-1\AP\POC1:Jon Jones ;**

- (2) Agency.

**T-1\AP\POC2:US Air Force ;**

- (3) Address.

**T-1\AP\POC3:123 Hanscom Lane, Edwards AFB, CA 93524 ;**

- (4) Telephone.

**T-1\AP\POC4 :DSN 555-1212 ;**

The XML snippet for the example above is shown in [Figure 5-33](#). [Figure 5-34](#) shows the relevant part of the XML schema in graphical form. [Table 5-1](#) shows the XML-to-TMATS code name mapping for this example.

```

<TmatsG:TransmissionAttributes TmatsCommon:TmatsVersion="106-13">
  <TmatsT:SourceRFAttributes>
    <TmatsT:TransmitterID>ST405S 977</TmatsT:TransmitterID>
    <TmatsT:Frequency>2251.5</TmatsT:Frequency>
    <TmatsT:RFBandwidth>2.0</TmatsT:RFBandwidth>
    <TmatsT:DataBandwidth>750</TmatsT:DataBandwidth>
    <TmatsT:ModulationType>FM</TmatsT:ModulationType>
    <TmatsT:TotalCarrierModulation>750</TmatsT:TotalCarrierModulation>
    <TmatsT:Power>2.5</TmatsT:Power>
    <TmatsT:ModulatorNonLinearity>2.0</TmatsT:ModulatorNonLinearity>
    <TmatsT:PremodulationFilter>
      <TmatsT:Bandwidth>1400</TmatsT:Bandwidth>
      <TmatsT:Slope>6.0</TmatsT:Slope>
      <TmatsT:Type>Constant Amplitude</TmatsT:Type>
    </TmatsT:PremodulationFilter>
    <TmatsT:TransmitAntenna>
      <TmatsT:Type>Blade</TmatsT:Type>
      <TmatsT:Polarization>Linear</TmatsT:Polarization>
      <TmatsT:Location>BELLY</TmatsT:Location>
    </TmatsT:TransmitAntenna>
    <TmatsT:AntennaPatterns>
      <TmatsT:Document>Dwg A2345-1 </TmatsT:Document>
      <TmatsT:PointOfContact>
        <TmatsCommon:Name>Jon Jones</TmatsCommon:Name>
        <TmatsCommon:Agency>Air Force</TmatsCommon:Agency>
        <TmatsCommon:Address>
          123 Hanscom Lane, Edwards AFB, CA 93524</TmatsCommon:Address>
        <TmatsCommon:Telephone>DSN 555-1212</TmatsCommon:Telephone>
      </TmatsT:PointOfContact>
    </TmatsT:AntennaPatterns>
  </TmatsT:SourceRFAttributes>
</TmatsG:TransmissionAttributes>
<TmatsG:DataLink Name="PCM DATA LINK">
  <TmatsP:PCMFormatAttributes TmatsP:TmatsVersion="106-13">
    <TmatsP:InputData>
      <TmatsP:PCMCode>NRZ-L</TmatsP:PCMCode>
      <TmatsP:BitRate>2000000</TmatsP:BitRate>
    </TmatsP:InputData>
  </TmatsP:PCMFormatAttributes>
</TmatsG:DataLink>

```

Figure 5-33. Transmission Attributes Group Example XML

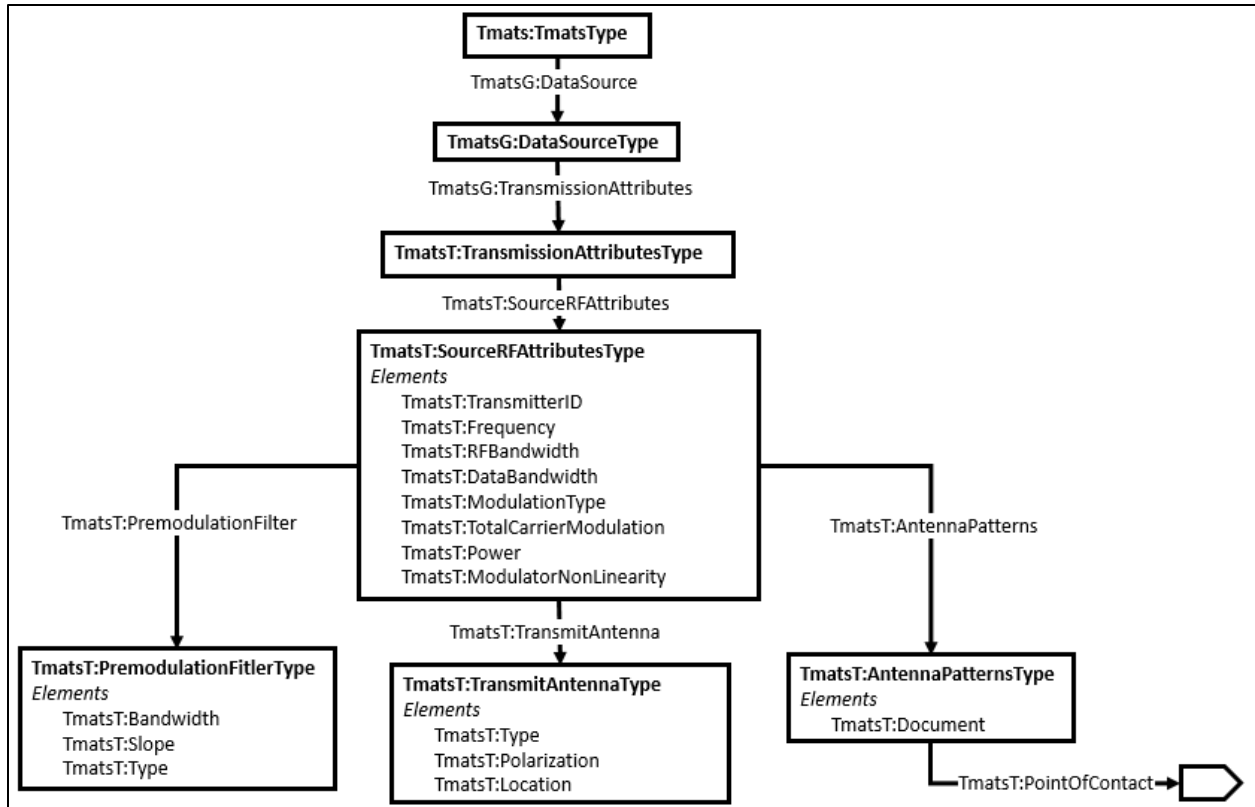

Figure 5-34. Transmission Attributes Group Example XML Schema

Table 5-1. Transmission Attributes Group XML Element-TMATS Code Name Pair	
XML Element Relative to Tmats:Tmats/ TmatsG:TransmissionAttributes/ TmatsT:SourceRFAttributes	Code Name
TmatsT:TransmitterID	[T-x\TID]
TmatsT:Frequency	[T-x\RF1]
TmatsT:RFBandwidth	[T-x\RF2]
TmatsT:DataBandwidth	[T-x\RF3]
TmatsT:ModulationType	[T-x\RF4]
TmatsT:TotalCarrierModulation	[T-x\RF5]
TmatsT:Power	[T-x\RF6]
TmatsT:ModulatorNonLinearity	[T-x\RF7]
TmatsT:PremodulationFilter/TmatsT:Bandwidth	[T-x\PMF1]
TmatsT:PremodulationFilter/TmatsT:Slope	[T-x\PMF2]
TmatsT:PremodulationFilter/TmatsT:Type	[T-x\PMF3]
TmatsT:TransmitAntenna/TmatsT:Type	[T-x\AN1]
TmatsT:TransmitAntenna/TmatsT:Polarization	[T-x\AN2]
TmatsT:TransmitAntenna/TmatsT:Location	[T-x\AN3]

TmatsT:AntennaPatterns/TmatsT:Document	[T-x\AP]
TmatsT:AntennaPatterns/TmatsT:PointOfContact/TmatsCmmon:Name	[T-x\AP\POC1]
TmatsT:AntennaPatterns/TmatsT:PointOfContact/TmatsCmmon:Agency	[T-x\AP\POC2]
TmatsT:AntennaPatterns/TmatsT:PointOfContact/TmatsCmmon:Address	[T-x\AP\POC3]
TmatsT:AntennaPatterns/TmatsT:PointOfContact/TmatsCmmon:Telephone	[T-x\AP\POC4]

This concludes the attributes associated with the RF source.

#### 5.4.2 Ground Station Attributes

Ground station attributes are used to configure the receiving station equipment. These attributes could be provided by the flight system engineer, but more often they must be determined and added to the TMATS file by the ground station operator based on the available ground station equipment. Once determined and verified, these attributes can be used repeatedly to automate the setup of the station for a particular test.

The receiver filters are defined below. The receiver intermediate frequency (IF) filter is set to pass only the signal of interest. The bandwidth is defined at the 3-dB point in MHz. The final output filter is the last filter before the signal is sent to the information processing equipment. This filter is commonly referred to as the video filter and is specified in kHz at the 3-dB point.

- a. IF Bandwidth. The IF filter is set to 1.5 MHz.  
**T-1\GST1:1.5;**
- b. Baseband Composite Bandwidth. The video filter is set to 750 kHz.  
**T-1\GST2:750;**
- c. AGC Time Constant. This is the time required for the receiver automatic gain control circuit to respond to changes in signal level. This usually depends on the type of vehicle being tracked, and is expressed in milliseconds.  
**T-1\GST3:10;**
- d. MGC Gain Set Point. The manual gain control setting of the receiver may be specified here. This setting must be determined by the ground station operator, and is only used in special test conditions. The setting is specified in terms of received signal strength in dBm.  
**T-1\GST4:85;**
- e. AFC/APC. For an FM transmitter, this mode selection would be set to Automatic Frequency Control. Automatic Phase Control (APC) would be selected for a phase-modulated signal or this could be disabled by specifying none (NON).  
**T-1\GST5:AFC;**
- f. Tracking Bandwidth. The receiver tracking loop bandwidth, specified in Hz, must be determined according to the dynamics of the vehicle being received. A narrow tracking loop reduces the chances of a loss of signal lock while filtering certain types of noise, but compromises signal lock due to vehicle dynamics. This setting therefore involves a tradeoff between the two opposing considerations and is best left to the expertise of the ground station operator.  
**T-1\GST6:2000;**

- g. Polarization Reception. This depends on the ground station equipment available; a common setup is to use both LHCP and RHCP fed to a pre-detection diversity combiner, which will output the best signal to the recording and/or data display system.  
**T-1\GST7:B&DPR;**
- h. Discriminator Bandwidth. For an FM receiver system, the bandwidth of the discriminator is specified in kHz.  
**T-1\FM1:35;**
- i. Discriminator Linearity. The linearity over the given bandwidth is specified as an error percentage. A typical specification is  $\pm 3\%$ .  
**T-1\FM2:3.0;**
- j. Phase-Locked Loop Bandwidth. For a PM system, the tracking bandwidth of the phase detector is specified. This affects the tracking filter characteristics and is specified in Hz. A high-bandwidth phase-locked loop (PLL) provides a fast lock time and tracks jitter on the reference clock source, passing it through to the PLL output. A low-bandwidth PLL filters out reference clock jitter, but increases lock time. A typical setting is 0.1% of the data rate. For the example of a 2-Mbps data rate, this attribute would be set to 2000.  
**T-1\PLL:2000;**
- k. Comments. This attribute may be used to add any additional information that would add clarification to any of the above attributes. Use of the comment field is discouraged if the information can be adequately entered in the above attributes.  
**T-1\COM: The above parameters fully combine the required attributes of this example.;**

The XML snippet for the example above is shown in [Figure 5-35](#). [Figure 5-36](#) shows the relevant part of the XML schema in graphical form. [Table 5-2](#) shows the XML-to-TMATS code name mapping for this example.

```

<TmatsT:GroundStationAttributes>
  <TmatsT:IFBandwidth>1.5</TmatsT:IFBandwidth>
  <TmatsT:BasebandCompositeBandwidth>750</TmatsT:BasebandCompositeBandwidth>
  <TmatsT:GainControl>
    <TmatsT:AGCTimeConstant>10</TmatsT:AGCTimeConstant>
    <TmatsT:MGCGainSetPoint>85</TmatsT:MGCGainSetPoint>
    <TmatsT:AFC APC>Automatic Frequency Control</TmatsT:AFC APC>
    <TmatsT:TrackingBandwidth>2000</TmatsT:TrackingBandwidth>
    <TmatsT:PolarizationReception>
      Both And Pre-Detection
    </TmatsT:PolarizationReception>
  </TmatsT:GainControl>
  <TmatsT:FMSystems>
    <TmatsT:DiscriminatorBandwidth>35</TmatsT:DiscriminatorBandwidth>
    <TmatsT:DiscriminatorLinearity>3.0</TmatsT:DiscriminatorLinearity>
  </TmatsT:FMSystems>
  <TmatsT:PMSystems>
    <TmatsT:PhaseLockLoopBandwidth>2000</TmatsT:PhaseLockLoopBandwidth>
  </TmatsT:PMSystems>
</TmatsT:GroundStationAttributes>

```

Figure 5-35. Ground Station Attributes Group Example XML



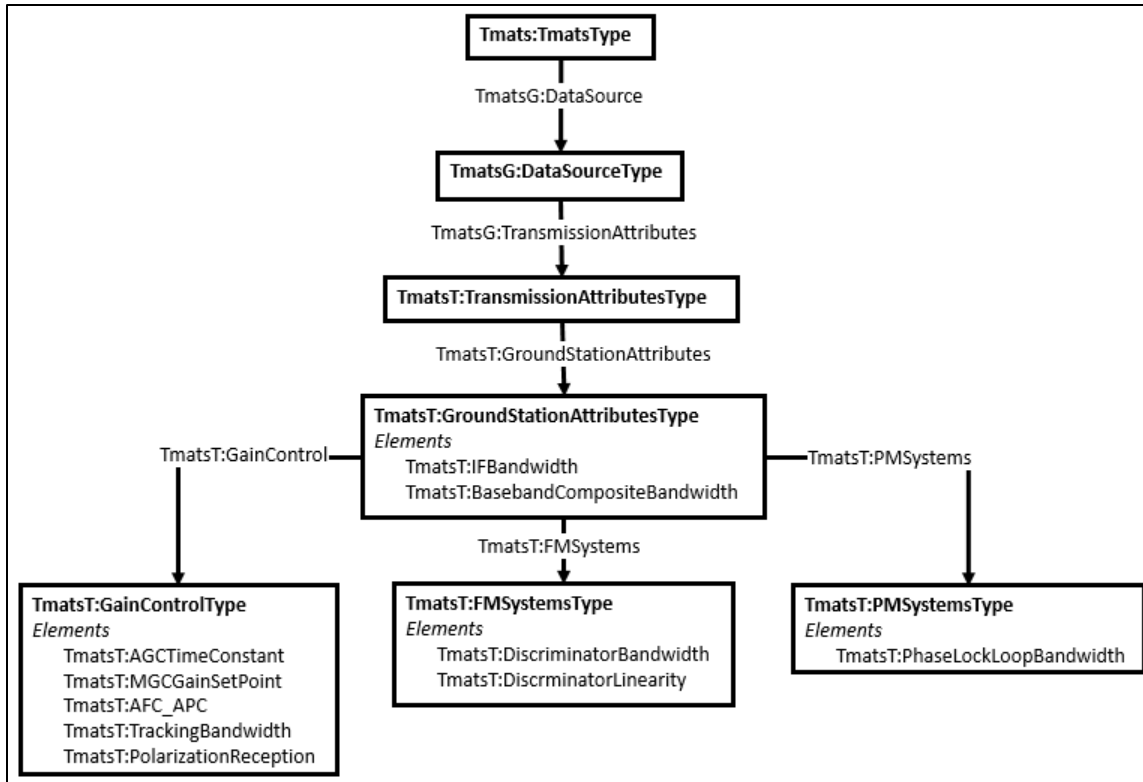

Figure 5-36. Ground Station Attributes Group Example XML Schema

<b>Table 5-2. Ground Station Attributes Group XML Element-TMATS Code Name Pair</b>	
<b>XML Element Relative to Tmats:Tmats/ TmatsG:DataSource/ TmatsG:TransmissionAttributes/ TmatsT:GroundStationAttributes</b>	<b>Code Name</b>
TmatsT:IFBandwidth	[T-x\GST1]
TmatsT:BasebandCompositeBandwidth	[T-x\GST2]
TmatsT:GainControl/TmatsT:AGCTimeConstant	[T-x\GST3]
TmatsT:GainControl/TmatsT:MGCGainSetPoint	[T-x\GST4]
TmatsT:GainControl/TmatsT:AFC_APC	[T-x\GST5]
TmatsT:GainControl/TmatsT:TrackingBandwidth	[T-x\GST6]
TmatsT:GainControl/TmatsT:PolarizationReception	[T-x\GST7]
TmatsT:FMSystems/TmatsT:DiscriminatorBandwidth	[T-x\FM1]
TmatsT:FMSystems/TmatsT:DiscriminatorLinearity	[T-x\FM2]
TmatsT:PMSystems/TmatsT:PhaseLockLoopBandwidth	[T-x\PLL]

## 5.5 Chapter 10 Recorder Examples

The R-Group defines recorded data sources such as magnetic tapes as specified in RCC IRIG 106, Appendix D<sup>12</sup> or data storage devices as specified in RCC IRIG 106, Chapter 10,<sup>13</sup> which is the digital recording standard that defines the operational requirements for digital data recording devices. Another useful document is the Chapter 10 Programming Handbook.<sup>14</sup> The purpose of the handbook is to assist software programmers when they are developing software to operate Chapter 10 recorders or when they are developing software to analyze data from Chapter 10 recorders.

In RCC IRIG 106, Chapter 9 (TMATS), the R-Group table defines the following required attributes.

- a. An R/R Ch10 status with a value of “R” shall indicate the minimum required Chapter 10 TMATS Setup Record attributes.
- b. An R/R Ch10 Status with a value “RO” shall indicate the minimum required TMATS Setup Record attributes for portions of Chapter 10 that are optional and/or supported data channel dependent.
- c. An R/R Ch10 Status with a value of “RO-PAK” shall indicate the Chapter 10 TMATS Setup Record attributes when the Data Packing Option (R-x\PDP-n) is UNPACKED (UN) or PACKED (PFS).

The R-Group is tied to the:

- a. G-Group via the Data Source ID (G\DSI-n to R-x\ID).
- b. P-Group via the Channel Data Link Name (R-x\CDLN-n) to the Data Link Name (P-d\DLN).
- c. B-Group via the Channel Data Link Name (R-x\CDLN-n) or Sub-Channel Name (R-x\ANM-n-m)) to the Data Link Name (B-x\DLN).
- d. S-Group via the Channel Data Link Name (R-x\CDLN-n), Sub-Channel Name (R-x\UCNM-n-m or R-x\MCNM-n-m), or Network Name (R-x\ENAM-n-m) to the Data Link Name (S-d\DLN).
- e. C-Group via the Measurement Name (R-x\AMN-n-m) to the Data Conversion Name (C-d\DCN).

The Chapter 10 examples with multiple data sources/tracks are shown in the following paragraphs. The G-Group, R-Group, and P-Group examples are all part of the same TMATS file

---

<sup>12</sup> Range Commanders Council. “Magnetic Tape Recorder and Reproducer Information and Use Criteria,” in *Telemetry Standards*. IRIG 106-15. July 2015. Available at [http://www.wsmr.army.mil/RCCsite/Documents/106-15\\_Telemetry\\_Standards/appendixD.pdf](http://www.wsmr.army.mil/RCCsite/Documents/106-15_Telemetry_Standards/appendixD.pdf).

<sup>13</sup> Range Commanders Council. “Digital Recording Standard,” in *Telemetry Standards*. IRIG 106-15. July 2015. Available at [http://www.wsmr.army.mil/RCCsite/Documents/106-15\\_Telemetry\\_Standards/chapter10.pdf](http://www.wsmr.army.mil/RCCsite/Documents/106-15_Telemetry_Standards/chapter10.pdf).

<sup>14</sup> Range Commanders Council. *IRIG 106-07 Chapter 10 Programming Handbook*. RCC 123-09. March 2009. May be superseded by update. Available at [http://www.wsmr.army.mil/RCCsite/Documents/123-09\\_IRIG\\_106-07\\_Chapter\\_10\\_Programming\\_Handbook/](http://www.wsmr.army.mil/RCCsite/Documents/123-09_IRIG_106-07_Chapter_10_Programming_Handbook/).

that describes a typical Chapter 10 recorder. This recorder can record IRIG time, four channels of PCM, four channels of 1553 data bus, and three channels of MPEG-2 Video.

### 5.5.1 G-Group Example.

The G-Group contains general information about the project.

Each TMATS file can have one G\COM attribute for an overall comment about the file.

**G\COM:TMATS Generated on 03-12-2010 at 15:03:01;**

Other comments should be generated with the COMMENT attribute.

**COMMENT:Chapter 10 Recorder 1;**

- a. Program Name. This is the program name.  
**G\PN:Chapter10Example;**
- b. Test Item. This is the name of the test article (typically an aircraft).  
**G\TA:ABC-123;**
- c. TMATS File Name. This is the name of this TMATS file.  
**G\FN:CH10\_Standalone\_Recorder1.tmt;**
- d. RCC IRIG 106 Revision Level. This identifies the RCC IRIG 106 version that the TMATS file was based upon. The format to describe version is 106-xx, with xx being the last two digits of the year. This is the required TMATS version number attribute.  
**G\106:09;**
- e. Origination Date. This is the origination date of the project.  
**G\OD:03-17-2010;**
- f. Revision Number. This is the revision number. This number should be incremented every time the configuration of the recorder changes.  
**G\RN:2;**
- g. Revision Date. This is the last revision date of the project.  
**G\RD:03-19-2010;**
- h. Test Number. This is the test number.  
**G\TN:1;**
- i. Number of POCs. This project has no POCs.  
**G\POC\N:0;**
- j. Security Classification. This project is unclassified.  
**G\SC:U;**
- k. Number of Data Sources. This recording contains 1 data source.  
**G\DSI\N:1;**
- l. Data Source ID. The name of the data source is DS\_Chapter10Example.  
**G\DSI-1:DS\_CHAPTER10EXAMPLE;**
- m. Data Source Type. The type of the data source is distributed source.  
**G\DST-1:DSS;**

*Best practice - include a point of contact in all TMATS files.*

### 5.5.2 R-Group Example

The R-Group contains a set of attributes that describe the recorder. Events and indices are also described. A list of all of the channels in the recording is also included.

A description of the general setup follows.

- a. Data Source ID. The ID attribute ties this R-Group entry to the data source defined in the G-Group's DSI-1 attribute.

**R-1\ID:DS\_CHAPTER10EXAMPLE;**

- b. Recorder-Reproducer ID. The recorder identification is recorder1.

**R-1\RID:Recorder1;**

- c. Recorder-Reproducer Manufacturer. This attribute lists the vendor's name for the recorder.

**R-1\RI1:VendorName;**

- d. Recorder-Reproducer Media Type. The media type is solid-state recorder (SSR).

**R-1\TC1:SSR;**

- e. Recorder-Reproducer Media Location. This attribute indicates the location of the recorder media. In this case, the location is internal to the recorder.

**R-1\RRML:I;**

- f. External RMM Bus Speed. This attribute indicates the speed of the IEEE-1394 interface. AUTO means that the speed is automatically selected.

**R-1\ERBS:AUTO;**

- g. Number of Source Bits. This attribute indicates the number of most significant bits of the channel ID used for the multiplexer source ID.

**R-1\NSB:3;**

- h. Recorder-Reproducer Model. This attribute indicates the model number of the recorder.

**R-1\RI2:CustomRecorder;**

- i. Original Recording. Is this an original recording?

**R-1\RI3:Y;**

- j. Post Process Modified Recording. This attribute indicates if the recording has been modified in post-processing.

**R-1\RI6:N;**

- k. Continuous Recording Enabled. This attribute indicates if continuous recording is enabled.

**R-1\CRE:F;**

- l. Recorder-Reproducer Setup Source. This attribute indicates the source of the recorder setup. In this case, "C" indicates Command Setup File Only.

**R-1\RSS:C;**

- m. Recording Events Enabled. This attribute indicates that events are disabled on this recorder.

**R-1\EV\E:F;**

- n. Number of Recording Events. There are no events defined on this recorder.

**R-1\EV\N:0;**

- o. Recorder Internal Events Enabled. This attribute indicates that recorder internal events are disabled on this recorder.

**R-1\EV\IEE:F;**

- p. Recording Index Enabled. This attribute indicates that indices are disabled on this recorder.

**R-1\IDX\E:F;**

- q. Recording Index Type. Index type is set to count (C).

**R-1\IDX\IT:C;**

- r. Index Count Value. This attribute indicates that one packet will be generated for each index entry.

**R-1\IDX\ICV:1;**

- s. Number of Tracks/Channels. This attribute indicates that this recorder has 12 data channels.

**R-1\N:12;**

The XML snippet for the example above is shown in [Figure 5-37](#). [Figure 5-38](#) shows the relevant part of the XML schema in graphical form. [Table 5-3](#) shows the XML-to-TMATS code name mapping for this example.

```

<TmatsG:RecorderReproducerAttributes TmatsCommon:TmatsVersion="106-13">
  <TmatsR:ID>Recorder1</TmatsR:ID>
  <TmatsR:Characteristics>
    <TmatsR:Type>Solid State Recorder</TmatsR:Type>
    <TmatsR:Manufacturer>VendorName</TmatsR:Manufacturer>
    <TmatsR:MediaLocation>Internal</TmatsR:MediaLocation>
    <TmatsR:ExternalRMMBusSpeed>Auto</TmatsR:ExternalRMMBusSpeed>
    <TmatsR:NumberOfTracksOrChannels>12</TmatsR:NumberOfTracksOrChannels>
    <TmatsR:NumberOfSourceBits>3</TmatsR:NumberOfSourceBits>
  </TmatsR:Characteristics>
  <TmatsR:RecorderReproducerInfo>
    <TmatsR:Manufacturer >VendorName</TmatsR:Manufacturer>
    <TmatsR:Model>CustomRecorder</TmatsR:Model>
    <TmatsR:OriginalRecording>Yes</TmatsR:OriginalRecording>
    <TmatsR:PostProcessModifiedRecording>
      No
    </TmatsR:PostProcessModifiedRecording>
    <TmatsR:ContinuousRecordingEnabled>
      False
    </TmatsR:ContinuousRecordingEnabled>
    <TmatsR:SetupSource>Command Setup File Only</TmatsR:SetupSource>
  </TmatsR:RecorderReproducerInfo>
  <TmatsR:RecordingEventDefinitions>
    <TmatsR:Enabled>False</TmatsR:Enabled>
    <TmatsR:InternalEventsEnabled>False</TmatsR:InternalEventsEnabled>
    <TmatsR:RecordingIndex>
      <TmatsR:Enabled>False</TmatsR:Enabled>
      <TmatsR:Type>Count</TmatsR:Type>
      <TmatsR:CountValue>1</TmatsR:CountValue>
    </TmatsR:RecordingIndex>
  </TmatsR:RecordingEventDefinitions>
</TmatsG:RecorderReproducerAttributes>

```

Figure 5-37. R-Group Example XML

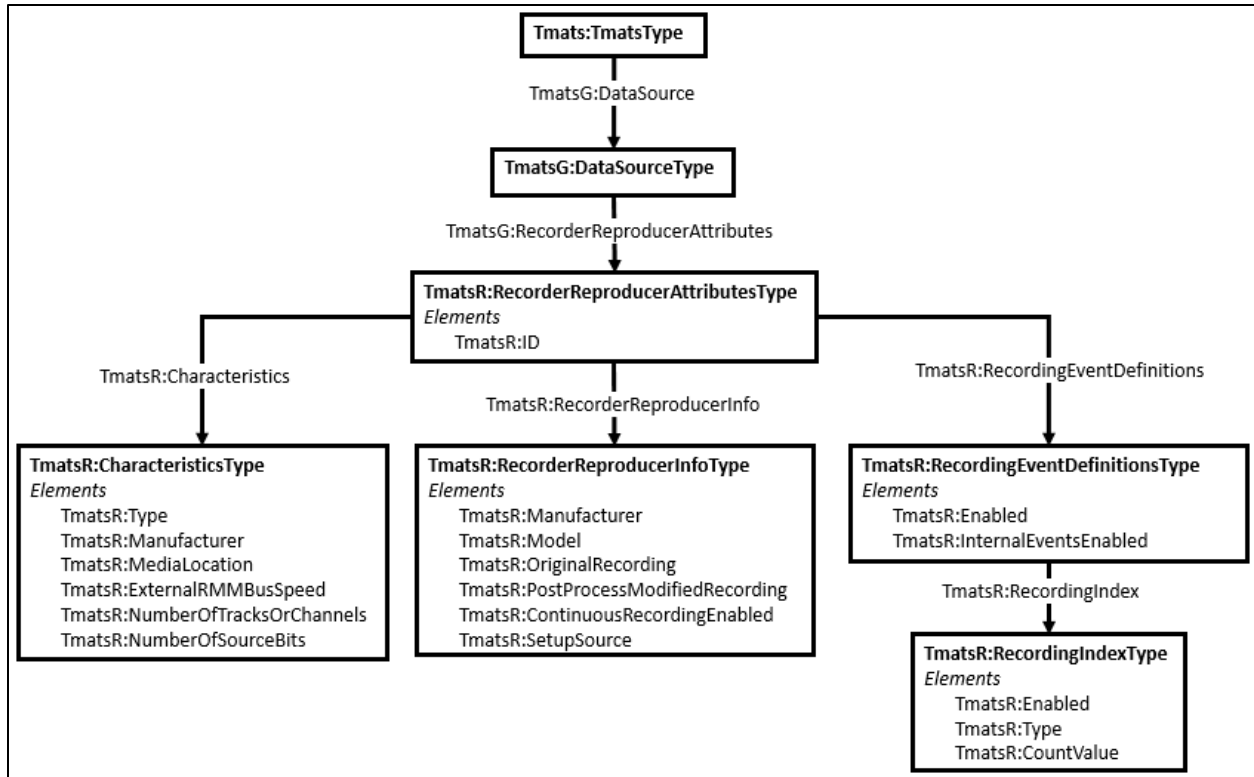

Figure 5-38. R-Group Example XML Schema

<b>Table 5-3. R-Group XML Element-TMATS Code Name Pair</b>	
<b>XML Element Relative to Tmats:Tmats/ TmatsG:DataSource/ TmatsG:RecorderReproducerAttributes</b>	<b>Code Name</b>
TmatsR:ID	[R-x\RID]
TmatsR:Characteristics/TmatsR:Type	[R-x\TC1]
TmatsR:Characteristics/TmatsR:MediaLocation	[R-x\RML]
TmatsR:Characteristics/TmatsR:ExternalRMMBusSpeed	[R-x\ERBS]
TmatsR:Characteristics/TmatsR:NumberOfSourceBits	[R-x\NSB]
TmatsR:Characteristics/TmatsR:NumberOfTracksOrChannels	[R-x\N]
<b>XML Element Relative to Tmats:Tmats/ TmatsG:DataSource/ TmatsG:RecorderReproducerAttributes/ TmatsR:RecorderReproducerInfo</b>	
TmatsR:Model	[R-x\RI2]
TmatsR:OriginalRecording	[R-x\RI3]
TmatsR:PostProcessModifiedRecording	[R-x\RI6]
TmatsR:ConinuousRecordingEnabled	[R-x\CRE]
TmatsR:SetupSource	[R-x\RSS]

XML Element Relative to Tmats:Tmats/ TmatsG:DataSource/ TmatsG:RecorderReproducerAttributes/ TmatsR:RecordingEventDefinitions	
TmatsR:Enabled	[R-x\EV\E]
TmatsR:InternalEventsEnabled	[R-x\EV\IEE]
TmatsR:RecordingIndex/Type	[R-x\IDX\IT]
TmatsR:RecordingIndex/TmatsR:CountValue	[R-\IDX\ICV]

### 5.5.3 Sample Time Channel

*Best practice - list the time channel first in the TMATS file.*

- a. Track Number/Channel ID. All Chapter 10 recorders must have a time channel. The channel ID for the time channel is listed in the TK1 attribute. Channel IDs can be assigned sequentially or they can be assigned based on the hardware configuration.  
**R-1\TK1-12:640;**
  - b. Recording Technique. The recording technique is solid state.  
**R-1\TK2-12:SSR;**
  - c. Data Source ID. This is the data source ID for this channel.  
**R-1\DSI-12:640;**
  - d. Data Direction. The data direction is forward.  
**R-1\TK3-12:FWD;**
  - e. Recorder Physical Channel Number. This attribute stores the physical recorder channel number. In this case, the value is identical to TK1.  
**R-1\TK4-12:640;**
  - f. Channel Enable. This attribute indicates if the channel is enabled or disabled.  
**R-1\CHE-12:T;**
  - g. Channel Data Type. This attribute indicates the data type for the channel.  
**R-1\CDT-12:TIMEIN;**
  - h. Channel Data Link Name. The channel data link name for this channel is also 640.  
**R-1\CDLN-12:640;**
- The next 3 attributes are time-channel-specific.
- i. Time Data Type Format. The time data type format is Format 1.  
**R-1\TTF-12:1;**
  - j. Time Format. The time format is IRIG-B.  
**R-1\TFMT-12:B;**
  - k. Time Source. The time source is internal.  
**R-1\TSRC-12:I;**

The XML snippet for the example above is shown in [Figure 5-39](#). [Figure 5-40](#) shows the relevant part of the XML schema in graphical form. [Table 5-4](#) shows the XML-to-TMATS code name mapping for this example.

```

<TmatsR:Data>
  <TmatsR:TrackNumberOrChannelID>640</TmatsR:TrackNumberOrChannelID>
  <TmatsR:RecordingTechnique>Solid State</TmatsR:RecordingTechnique>
  <TmatsR:DataSourceID>640</TmatsR:DataSourceID>
  <TmatsR:DataDirection>Forward</TmatsR:DataDirection>
  <TmatsR:RecorderPhysicalChannelNumber>
    640
  </TmatsR:RecorderPhysicalChannelNumber>
  <TmatsR:ChannelEnable>True</TmatsR:ChannelEnable>
  <TmatsR:ChannelDataType>Time Input</TmatsR:ChannelDataType>
  <TmatsR:ChannelDataLinkName>640</TmatsR:ChannelDataLinkName>
  <TmatsR:TimeDataTypeAttributes>
    <TmatsR:DataTypeFormat>Format 1 (Time Data)</TmatsR:DataTypeFormat>
    <TmatsR:TimeFormat>IRIG B</TmatsR:TimeFormat>
    <TmatsR:TimeSource>Internal</TmatsR:TimeSource>
  </TmatsR:TimeDataTypeAttributes>
</TmatsR:Data>
    
```

Figure 5-39. R-Group Sample Time Channel Example XML

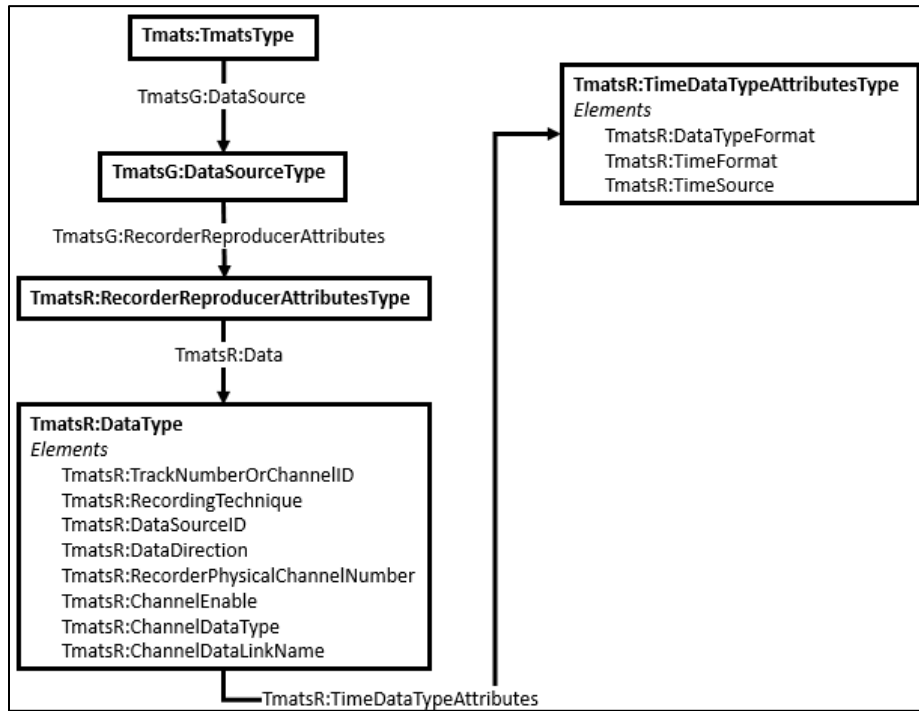

Figure 5-40. R-Group Sample Time Channel Example XML Schema

Table 5-4. R-Group Sample Time Channel XML Element-TMATS Code	
XML Element Relative to <b>Tmats:Tmats/                      TmatsG:DataSource/                      TmatsG:RecorderReproducerAttributes/                      TmatsR:Data</b>	<b>Code Name</b>



TmatsR:TrackNumberOrChannelID	[R-x\TK1-n]
TmatsR:RecordingTechnique	[R-x\TK2-n]
TmatsR:DataDirection	[R-x\TK3-n]
TmatsR:RecorderPhysicalChannelNumber	[R-x\TK4-n]
TmatsR:ChannelEnable	[R-x\CHE-n]
TmatsR:ChannelDataType	[R-x\CDT-n]
TmatsR:ChannelDataLinkName	[R-x\CDLN-n]
TmatsR:TimeDataTypeAttributes/TmatsR:DataTypeFormat	[R-x\TTF-n]
TmatsR:TimeDataTypeAttributes/TmatsR:TimeFormat	[R-x\TFMT-n]
TmatsR:TimeDataTypeAttributes/TmatsR:TimeSource	[R-x\TSRC-n]

#### 5.5.4 Sample PCM Channel.

The following describes a sample PCM channel.

- a. Channel ID. The channel ID is PCM-MUX-1.  
**R-1\TK1-1:PCM\_MUX\_1;**  
**R-1\TK2-1:SSR;**  
**R-1\DSI-1:PCM\_MUX\_1;**  
**R-1\TK3-1:FWD;**  
**R-1\TK4-1:PCM\_MUX\_1;**
- b. Channel Enabled. The PCM channel is enabled.  
**R-1\CHE-1:T;**
- c. Data Type. The data type is PCM.  
**R-1\CDT-1:PCMIN;**
- d. Channel Data Link Name. The channel data link name is PCM-MUX-1. This is used to link to a P-Group for this channel.  
**R-1\CDLN-1:PCM\_MUX\_1;**
- e. PCM Data Type Format. The format of the PCM data is Format 1 (RCC IRIG 106, Chapter 4/8).  
**R-1\PDTF-1:1;**
- f. Data Packing Option. Data is unpacked.  
**R-1\PDP-1:UN;**
- g. Input Clock Edge. The input clock edge is 0 degrees.  
**R-1\ICE-1:0;**
- h. Input Signal Type. The input signal type is RS-422 differential.  
**R-1\IST-1:RS422;**
- i. PCM Video Type Format. This stream does not contain embedded PCM video.  
**R-1\PTF-1:NONE;**
- j. PCM Recorder-Reproducer Minor Frame Filtering Enabled. Minor frame filtering is disabled.  
**R-1\MFF\E-1:F;**

- k. PCM Post Process Overwrite and Filtering Enabled. Post-processing overwrite and filtering is disabled.

**R-1\POF\E-1:F;**

The XML snippet for the example above is shown in [Figure 5-41](#). [Figure 5-42](#) shows the relevant part of the XML schema in graphical form. [Table 5-5](#) shows the XML-to-TMATS code name mapping for this example.

```

<TmatsR:Data>
  <TmatsR:TrackNumberOrChannelID>PCM MUX 1</TmatsR:TrackNumberOrChannel
  ID>
  <TmatsR:RecordingTechnique>Solid State</TmatsR:RecordingTechnique>
  <TmatsR:DataSourceID>PCM MUX 1</TmatsR:DataSourceID>
  <TmatsR:DataDirection>Forward</TmatsR:DataDirection>
  <TmatsR:ChannelEnable>True</TmatsR:ChannelEnable>
  <TmatsR:ChannelDataType>PCM Input</TmatsR:ChannelDataType>
  <TmatsR:ChannelDataLinkName>PCM MUX 1</TmatsR:ChannelDataLinkName>
  <TmatsR:PCMDDataTypeAttributes>
    <TmatsR:DataTypeFormat>Format 1 (IRIG 106 Ch
    4/8)</TmatsR:DataTypeFormat>
    <TmatsR:DataPackingOption>Unpacked</TmatsR:DataPackingOption>
    <TmatsR:InputClockEdge>0 Degrees</TmatsR:InputClockEdge>
    <TmatsR:InputSignalType>
      RS-422 Standard Differential</TmatsR:InputSignalType>
    <TmatsR:VideoTypeFormat>None</TmatsR:VideoTypeFormat>
    <TmatsR:MinorFrameFilteringEnabled>
      False
    </TmatsR:MinorFrameFilteringEnabled>
    <TmatsR:PostProcessOverwriteAndFiltering>
      <TmatsR:Enabled>False</TmatsR:Enabled>
    </TmatsR:PostProcessOverwriteAndFiltering>
  </TmatsR:PCMDDataTypeAttributes>
</TmatsR:Data>

```

Figure 5-41. R-Group Sample PCM Channel Example XML

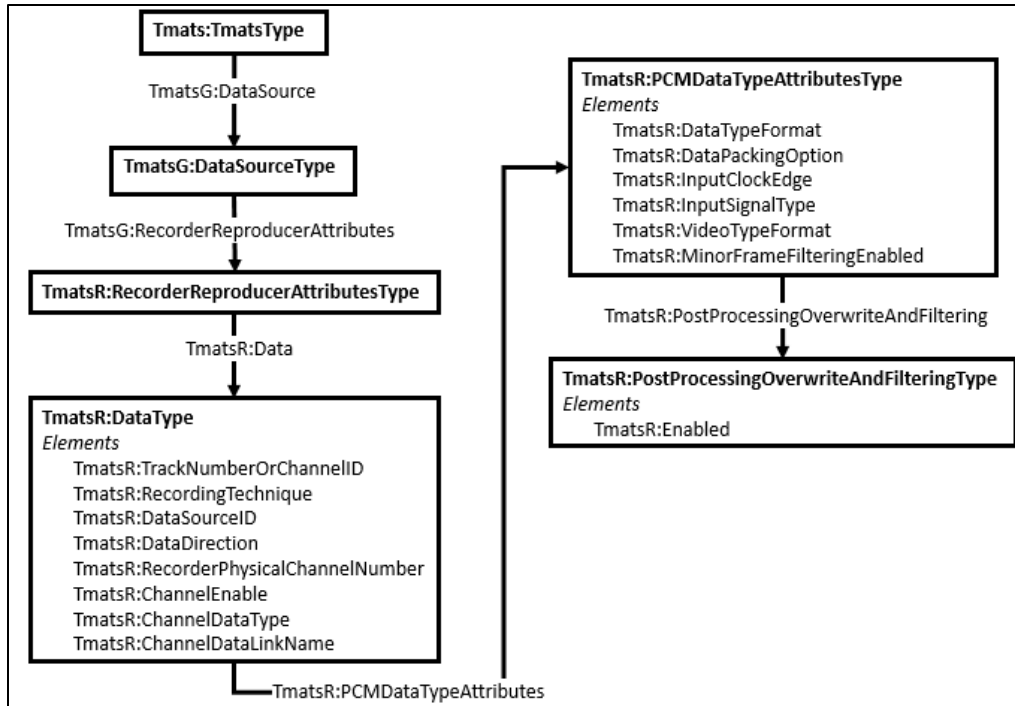

Figure 5-42. R-Group Sample PCM Channel Example XML Schema

Table 5-5. R-Group Sample PCM Channel XML Element-TMATS Code Name Pair	
XML Element Relative to Tmats:Tmats/ TmatsG:DataSource/ TmatsG:RecorderReproducerAttributes/ TmatsR:Data/ TmatsR:PCMDATAAttributes	Code Name
TmatsR:DataTypeFormat	[R-x\PDTF-n]
TmatsR:DataPackingOption	[R-x\PDP-n]
TmatsR:InputClockEdge	[R-x\ICE-n]
TmatsR:InputSignalType	[R-x\IST-n]
TmatsR:VideoTypeFormat	[R-x\PTF-n]
TmatsR:MinorFrameFilteringEnabled	[R-x\MFF\E-n]
TmatsR:PostProcessOverwriteAndFiltering/TmatsR:Enabled	[R-x\POF\E-n]

5.5.5 Sample 1553 Channel.

The following describes a sample 1553 channel.

- a. Channel ID. The channel ID is 1553-MUX-A.
  - R-1\TK1-5:1553\_MUX\_A;
  - R-1\TK2-5:SSR;
  - R-1\DSI-5:1553\_MUX\_A;
  - R-1\TK3-5:FWD;

**R-1\TK4-5:1553\_MUX\_A;**

- b. Channel Enabled. This channel is enabled.  
**R-1\CHE-5:T;**
  - c. Data Type. The data type for this channel is 1553.  
**R-1\CDT-5:1553IN;**
  - d. Channel Data Link Name. The channel data link name is 1553-MUX-A. This is used to link to a B-Group for this channel.  
**R-1\CDLN-5:1553\_MUX\_A;**
  - e. MIL-STD-1553 Bus Data Type Format. The format of the 1553 data is Format 1 (MIL-STD-1553B Data).  
**R-1\BTF-5:1;**
  - f. MIL-STD-1553 Recorder-Reproducer Filtering Enabled. 1553 filtering is enabled for this channel.  
**R-1\MRF\E-5:T;**
  - g. MIL-STD-1553 Post Process Overwrite and Filtering Enabled. Post-processing overwrite and filtering is enabled for this channel.  
**R-1\MOF\T-5:T;**
  - h. MIL-STD-1553 Message Filtering Definition Type. The filtering mode is exclusive. This means that the listed 1553 messages are **not recorded**.  
**R-1\MFD\FDT-5:EX;**
  - i. Number of Message Filtering Definitions. There are 2 filtered messages on this channel.  
**R-1\MFD\N-5:2;**
- Note: The following eight attributes refer to filtered message #1.**
- j. Message Type. The type of the message is remote terminal (RT)-RT.  
**R-1\MFD\MT-5-1:RTRT;**
  - k. Remote Terminal Address. The RT address for command word #1 is 0.  
**R-1\MFD\TRA-5-1:00000;**
  - l. Transmit/Receive Mode. The message is a receive message.  
**R-1\MFD\TRM-5-1:0;**
  - m. Subterminal Address. The sub-address for command word #1 is 26.  
**R-1\MFD\STA-5-1:11010;**
  - n. Data Word Count/Mode Code. The data word count for command word #1 is 5.  
**R-1\MFD\DWC-5-1:00101;**
  - o. RT/RT Remote Terminal Address. The RT address for command word #2 in the RT-RT message is 8.  
**R-1\MFD\RTRA-5-1:01000;**
  - p. RT/RT Subterminal Address. The sub-address for command word #2 in the RT-RT message is 9.  
**R-1\MFD\RSTA-5-1:01001;**

- q. RT/RT Data Word Count. The data word count for command word #2 in the RT-RT message is 5.

**R-1\MFD\RDWC-5-1:00101;**

**Note: The following five attributes refer to filtered message #2.**

- r. Message Type. The type of the message is RT-BC.

**R-1\MFD\MT-5-2:RTBC;**

- s. Remote Terminal Address. The RT address is 14.

**R-1\MFD\TRA-5-2:01110;**

- t. Transmit/Receive Mode. The message is a transmit message.

**R-1\MFD\TRM-5-2:1;**

- u. Subterminal Address. The sub-address is 7.

**R-1\MFD\STA-5-2:00111;**

- v. Data Word Count. The data word count is 18.

**R-1\MFD\DWC-5-2:10010;**

The XML snippet for the example above is shown in [Figure 5-43](#). [Figure 5-44](#) shows the relevant part of the XML schema in graphical form. [Table 5-6](#) shows the XML-to-TMATS code name mapping for this example.

```

<TmatsR:Data>
  <TmatsR:TrackNumberOrChannelID>1553 MUX A</TmatsR:TrackNumberOrChannelID>
  <TmatsR:RecordingTechnique>Solid State</TmatsR:RecordingTechnique>
  <TmatsR:DataSourceID>1553 MUX A</TmatsR:DataSourceID>
  <TmatsR:DataDirection>Forward</TmatsR:DataDirection>
  <TmatsR:RecorderPhysicalChannelNumber>
    1553 MUX A
  </TmatsR:RecorderPhysicalChannelNumber>
  <TmatsR:ChannelEnable>True</TmatsR:ChannelEnable>
  <TmatsR:ChannelDataType>1553 Input</TmatsR:ChannelDataType>
  <TmatsR:ChannelDataLinkName>1553 MUX A</TmatsR:ChannelDataLinkName>
  <TmatsR:MIL-STD-1553BusDataTypeAttributes>
    <TmatsR:BusDataTypeFormat>
      Format 1 (MIL-STD-1553B Data)
    </TmatsR:BusDataTypeFormat>
    <TmatsR:FilteringEnabled>True</TmatsR:FilteringEnabled>
    <TmatsR:PostProcessOverwriteAndFilteringEnabled>
      True
    </TmatsR:PostProcessOverwriteAndFilteringEnabled>
    <TmatsR:MessageFilteringType>
      Exclusive Filtering
    </TmatsR:MessageFilteringType>
    <TmatsR:MessageFilteringDefinitions>
      <TmatsR:Type>RT/RT</TmatsR:Type>
      <TmatsR:Address>
        <TmatsR:RemoteTerminalAddress>00000</TmatsR:RemoteTerminalAddress>
        <TmatsR:TransmitReceiveMode>Receive</TmatsR:TransmitReceiveMode>
        <TmatsR:SubTerminalAddress>11010</TmatsR:SubTerminalAddress>
        <TmatsR:DataWordCountOrModeCode>00101</TmatsR:DataWordCountOrModeCode>
      </TmatsR:Address>
      <TmatsR:RTRT>
        <TmatsR:Address>
          <TmatsR:RemoteTerminalAddress>01000</TmatsR:RemoteTerminalAddress>
          <TmatsR:SubTerminalAddress>01001</TmatsR:SubTerminalAddress>
          <TmatsR:DataWordCount>00101</TmatsR:DataWordCount>
        </TmatsR:Address>
      </TmatsR:RTRT>
    </TmatsR:MessageFilteringDefinitions>
    <TmatsR:MessageFilteringDefinitions>
      <TmatsR:Type>RT/BC</TmatsR:Type>
      <TmatsR:Address>
        <TmatsR:RemoteTerminalAddress>01110</TmatsR:RemoteTerminalAddress>
        <TmatsR:TransmitReceiveMode>Transmit</TmatsR:TransmitReceiveMode>
        <TmatsR:SubTerminalAddress>00111</TmatsR:SubTerminalAddress>
        <TmatsR:DataWordCountOrModeCode>10010</TmatsR:DataWordCountOrModeCode>
      </TmatsR:Address>
    </TmatsR:MessageFilteringDefinitions>
  </TmatsR:MIL-STD-1553BusDataTypeAttributes>
</TmatsR:Data>

```

Figure 5-43. R-Group Sample 1553 Channel Example XML

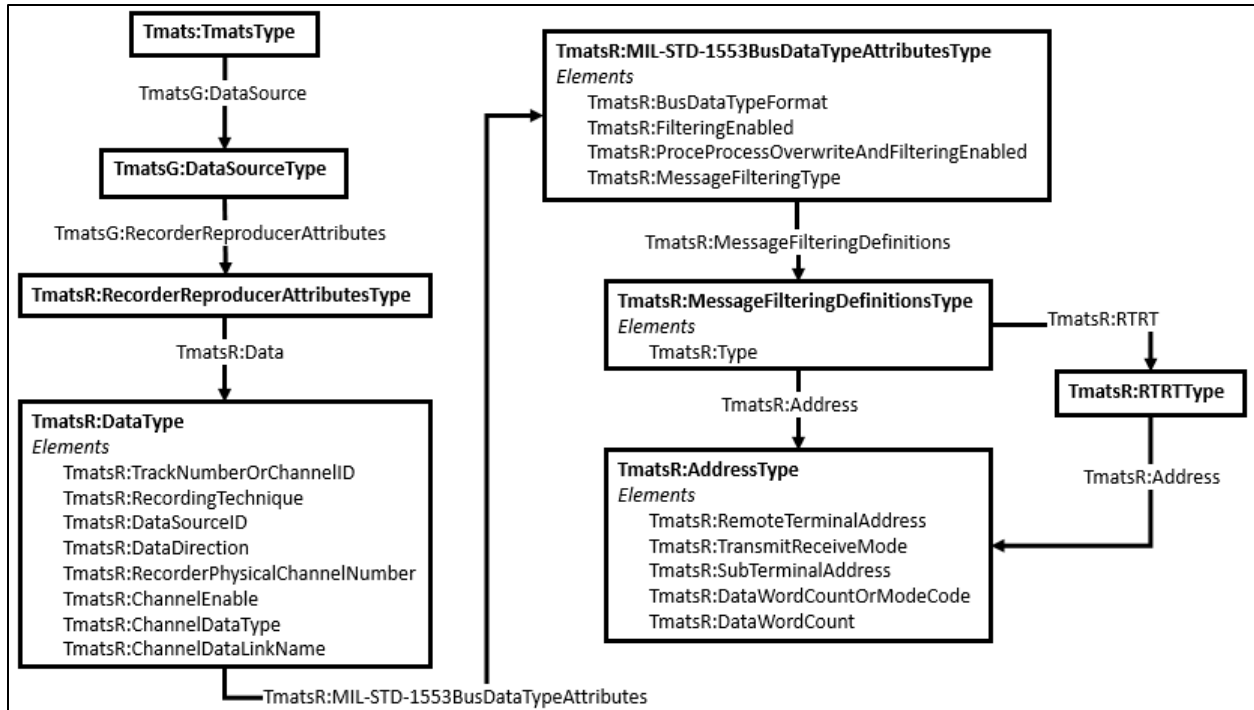

Figure 5-44. R-Group Sample 1553 Channel Example XML Schema

<b>Table 5-6. R-Group Sample 1553 Channel XML Element-TMATS Code Name Pair</b>	
<b>XML Element Relative to                      Tmats:Tmats/                      TmatsG:DataSource/                      TmatsG:RecorderReproducerAttributes/                      TmatsR:Data/                      TmatsR:MIL-STD-1553BusDataTypeAttributes</b>	<b>Code Name</b>
TmatsR:BusDataTypeFormat	[R-x\BTF-n]
TmatsR:FilteringEnabled	[R-x\MRF\E-n]
TmatsR:PostProcessOverwriteAndFilteringEnabled	[R-x\MOF\T-n]
TmatsR:MessageFilteringType	[R-x\MFD\FDT-n]
N/A	[R-x\MFD\N-n]
<b>XML Element Relative to                      Tmats:Tmats/                      TmatsG:DataSource/                      TmatsG:RecorderReproducerAttributes/                      TmatsR:Data/                      TmatsR:MIL-STD-1553BusDataTypeAttributes/                      TmatsR:MessageFilteringDefinitions</b>	
TmatsR:Type	[R-x\MFD\MT-n-m]
TmatsR:Address/TmatsR:RemoteTerminalAddress	[R-x\MFD\TRA-n-m]
TmatsR:Address/TmatsR:TransmitReceiveMode	[R-x\MFD\TRM-n-m]

TmatsR:Address/TmatsR:SubTerminalAddress	[R-x\MFD\STA-n-m]
TmatsR:Address/TmatsR:DataWordCountOrModeCode	[R-x\MFD\DWC-n-m]
TmatsR:RTRT/TmatsR:Address/TmatsR:RemoteTerminalAddress	[R-x\MFD\RTRA-n-m]
TmatsR:RTRT/TmatsR:Address/TmatsR:SubTerminalAddress	[R-x\MFD\RSTA-n-m]
TmatsR:RTRT/TmatsR:Address/TmatsR:DataWordCount	[R-x\MFD\RDWC-n-m]

### 5.5.6 Sample Video Channel.

The following describes a sample video channel.

- a. Channel ID. The channel ID is VIDEO-HUD.  
**R-1\TK1-9:VIDEO\_HUD;**  
**R-1\TK2-9:SSR;**  
**R-1\DSI-9:VIDEO\_HUD;**  
**R-1\TK3-9:FWD;**  
**R-1\TK4-9:VIDEO\_HUD;**
- b. Chanel Enabled. The video channel is enabled.  
**R-1\CHE-9:T;**
- c. Data Type. The data type for this channel is video.  
**R-1\CDT-9:VIDIN;**
- d. Data Link Name. The channel data link name is VIDEO-HUD.  
**R-1\CDLN-9:VIDEO\_HUD;**

**Note: The following attributes are video specific.**

- e. Video Data Type Format. This video data format is format #1 (MPEG-2 ISO 13818).  
**R-1\VTF-9:1;**
- f. MPEG-2 Channel XON2 Format. This type of video format is 2ON2 (MPEG-2).  
**R-1\VXF-9:0;**
- g. Video Signal Type. The video signal type is composite.  
**R-1\VST-9:1;**
- h. Video Signal Format Type. The video signal format type is NTSC.  
**R-1\VSF-9:1;**
- i. Video Variable Peak Bit Rate. The video bit rate is 3.14 Mbps.  
**R-1\VBR-9:3145728;**
- j. Video Encoding Delay. The video encoding delay is 300 ms.  
**R-1\VED-9:300;**
- k. Overlay Enabled. The video overlay is disabled.  
**R-1\VCO\OE-9:F;**
- l. Video Data Alignment. The video data alignment is big endian.  
**R-1\VDA-9:B;**



The XML snippet for the example above is shown in [Figure 5-45](#). [Figure 5-46](#) shows the relevant part of the XML schema in graphical form. Table 5-7 shows the XML-to-TMATS code name mapping for this example.

```

<TmatsR:Data>
  <TmatsR:TrackNumberOrChannelID>VIDEO HUD</TmatsR:TrackNumberOrChannelID>
  <TmatsR:RecordingTechnique>Solid State</TmatsR:RecordingTechnique>
  <TmatsR:DataSourceID>VIDEO HUD</TmatsR:DataSourceID>
  <TmatsR:DataDirection>Forward</TmatsR:DataDirection>
  <TmatsR:RecorderPhysicalChannelNumber>
    VIDEO HUD
  </TmatsR:RecorderPhysicalChannelNumber>
  <TmatsR:ChannelEnable>True</TmatsR:ChannelEnable>
  <TmatsR:ChannelDataType>Video Input</TmatsR:ChannelDataType>
  <TmatsR:ChannelDataLinkName>VIDEO HUD</TmatsR:ChannelDataLinkName>
  <TmatsR:VideoDataTypeAttributes>
    <TmatsR:DataTypeFormat>Format 1 (MPEG-2 ISO 13818)</TmatsR:DataTypeFormat>
    <TmatsR:MPEG2ChannelXON2Format>
      2ON2 (MPEG-2)
    </TmatsR:MPEG2ChannelXON2Format>
    <TmatsR:SignalType>Composite</TmatsR:SignalType>
    <TmatsR:SignalFormatType>NTSC</TmatsR:SignalFormatType>
    <TmatsR:VariablePeakBitRate>3.14</TmatsR:VariablePeakBitRate>
    <TmatsR:EncodingDelay>300</TmatsR:EncodingDelay>
    <TmatsR:Overlay>
      <TmatsR:Enabled>False</TmatsR:Enabled>
    </TmatsR:Overlay>
    <TmatsR:VideoDataAlignment>Big Endian</TmatsR:VideoDataAlignment>
  </TmatsR:VideoDataTypeAttributes>
</TmatsR:Data>

```

Figure 5-45. R-Group Sample Video Channel Example XML

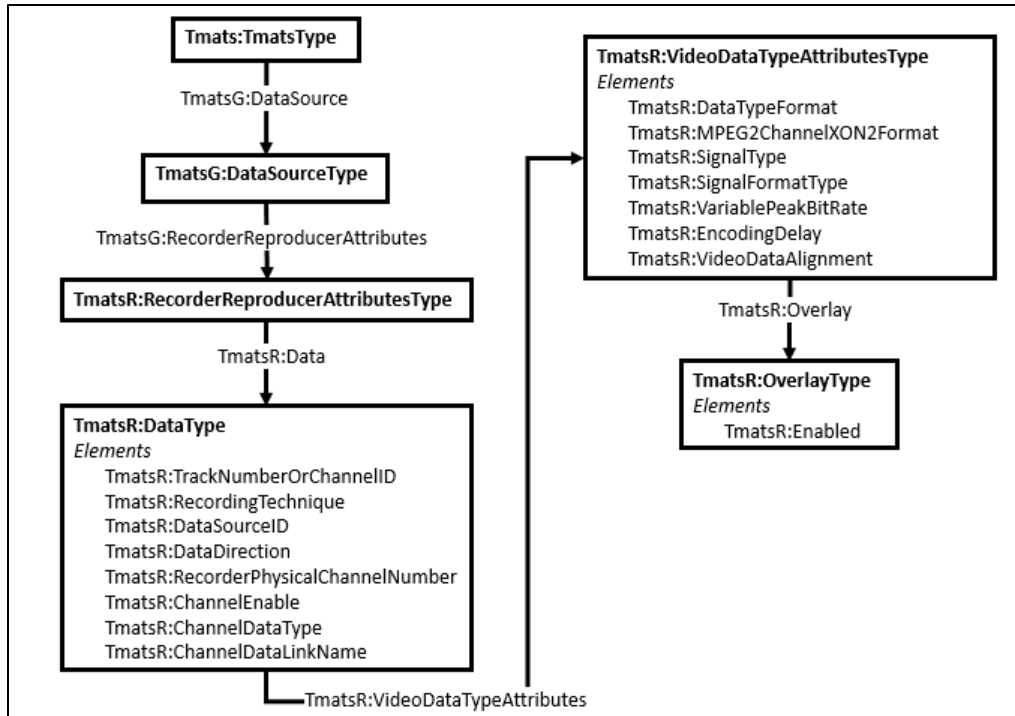

Figure 5-46. R-Group Sample Video Channel Example XML Schema

Table 5-7. R-Group Sample Video Channel XML element-TMATS code name pair	
XML Element Relative to Tmats:Tmats/ TmatsG:DataSource/ TmatsG:RecorderReproducerAttributes/ TmatsR:Data/ TmatsR:VideoDataTypeAttributes	Code Name
TmatsR:DataTypeFormat	[R-x\VTF-n]
TmatsR:MPEG2ChannelXON2Format	[R-x\VXF-n]
TmatsR:SignalType	[R-x\VST-n]
TmatsR:SignalFormatType	[R-x\VSF-n]
TmatsR:VariablePeakBitRate	[R-x\VBR-n]
TmatsR:EncodingDelay	[R-x\VED-n]
TmatsR:Overlay/TmatsR:Enabled	[R-x\VCO\OE-n]
TmatsR:VideoDataAlignment	[R-x\VDA-n]

5.5.7 P-Group Example.

Attributes from the P-Group are also required to define various characteristics of the PCM stream in a Chapter 10 recorder.

- a. Data Link Name. The data link name is PCM-MUX-1. This links this P-Group to the definition of a PCM channel in a Chapter 10 TMATS file.

**P-1\DLN:PCM\_MUX\_1;**

- b. PCM Code. The PCM code is NRZ-L.  
**P-1\D1:NRZ-L;**
  - c. Bit Rate. The bit rate is 1.5 Mbps.  
**P-1\D2:1500000;**
  - d. Data Encryption. The data is not encrypted.  
**P-1\D3:U;**
  - e. Data Polarity. The data polarity is normal.  
**P-1\D4:N;**
  - f. Automatic Polarity Correction. Automatic polarity correction is disabled.  
**P-1\D5:N;**
  - g. Data time sequence. The data time sequence is normal.  
**P-1\D6:N;**
  - h. Data Randomization. Data is not randomized.  
**P-1\D7:N;**
  - i. Randomizer Length. Since the data is not randomized, randomizer length is not applicable.  
**P-1\D8:N/A;**
  - j. PCM Format Type. This PCM channel is a Class 1 stream.  
**P-1\TF:ONE;**
  - k. Bits Per Word. The common word length is 16.  
**P-1\F1:16;**
  - l. Word Transfer Order. The word transfer order is msb first.  
**P-1\F2:M;**
  - m. Parity. Parity is disabled.  
**P-1\F3:NO;**
  - n. Parity Bit. The parity bit leads the data word.  
**P-1\F4:L;**
  - o. Minor Frames per Major Frame. There are 8 minor frames per major frame.  
**P-1\MF\N:8;**
  - p. Data Words per Minor Frame. Each minor frame contains 31 data words.  
**P-1\MF1:31;**
- Note:** What this means is that the format contains 30 data words of 16 bits each plus 1 sync word of 32-bits.
- q. Minor Frame. The total number of bits in the minor frame is  $512 = 16 * 30 + 32$ .  
**P-1\MF2:512;**
  - r. Sync Type. The sync type is fixed pattern.  
**P-1\MF3:FPT;**
  - s. The minor frame synchronization pattern is 32 bits long.

**P-1\MF4:32;**

- t. The minor frame synchronization pattern is 0xFE6B2840.

**P-1\MF5:1111110011010110010100001000000;**

- u. The number of good frames to acquire lock is 2 frames.

**P-1\SYNC1:2;**

- v. No bits can be incorrect in the synchronization pattern.

**P-1\SYNC2:0;**

- w. The number of bad frames to drop lock is 2 frames.

**P-1\SYNC3:2;**

- x. No bits can be incorrect in the synchronization pattern.

**P-1\SYNC4:0;**

- y. The number of subframe ID counters is 1.

**P-1\ISF\N:1;**

- z. The name of the first subframe ID counter is SFID1.

**P-1\ISF1-1:SFID1;**

- aa. Subframe Sync Type. The subframe sync type is ID for ID counter.

**P-1\ISF2-1:ID;**

- bb. SFID Word. The SFID word is located in word 1 in the PCM format.

**P-1\IDC1-1:1;**

- cc. The ID counter msb starting bit location is 14.

**P-1\IDC3-1:14;**

- dd. The SFID counter is 3 bits long.

**P-1\IDC4-1:3;**

- ee. The msb is transferred first.

**P-1\IDC5-1:M;**

- ff. The initial count of the SFID is 0.

**P-1\IDC6-1:0;**

- gg. Minor frame 1 is associated with SFID value 0.

**P-1\IDC7-1:1;**

- hh. The last value for the ID counter is 7.

**P-1\IDC8-1:7;**

- ii. Minor frame 8 is associated with SFID value 7.

**P-1\IDC9-1:8;**

- jj. The SFID counter is increasing.

**P-1\IDC10-1:INC;**

## 5.6 Packet Telemetry Downlink Example

The following examples identify how to interpret the stream as a Chapter 7 packet telemetry data.

### 5.6.1 Example 1

The following example describes a PCM frame, where the first 48 data words are used for carrying Chapter 4 PCM data, and words 49-127 are carrying a full Chapter 7 Packet Telemetry Data Frame:

	W1	W2	W3		...		W47	W48	W49	W50		...		W126	W127
FS	Chapter 4 PCM data words							Embedded Chapter 7 Packet Telemetry Data							

The following attributes will describe this Chapter 7 stream:

**P-1\C7\N:1;**  
**P-1\C7FW-1:49;**  
**P-1\C7NW-1:79;**

The number of bytes in the Chapter 7 Packet Telemetry Data Frame depends on the number of bits in the PCM Data Words. [Table 5-8](#) displays the Chapter 7 Packet Telemetry Data Frame Length, assuming all PCM data words have the same length.

Data Word length in bits	Calculation	Ch7 Frame length in bytes	Comment
8	79*8/8	79	no fill bits
12	79*12/8	118	4 bit is fill at the end
16	79*16/8	158	no fill bits

The XML snippet for the example above is shown in [Figure 5-47](#). [Figure 5-48](#) shows the relevant part of the XML schema in graphical form. [Table 5-9](#) shows the XML-to-TMATS code name mapping for this example. The code [P-d\ISF\N] does not apply because the number of counters can be inferred from the structure of the schema.

```
<TmatsG:PCMFormatAttributes TmatsCommon:ID="pcm-format-attributes-001"
  TmatsCommon:TmatsVersion="106-17">
  <TmatsP:Chapter7Format>
    <TmatsP:Chapter7FirstWordOfSegment>
      49
    </TmatsP:Chapter7FirstWordOfSegment>
    <TmatsP:Chapter7NumberOfPCMWordsInSegment>
      79
    </TmatsP:Chapter7NumberOfPCMWordsInSegment>
  </TmatsP:Chapter7Format>
</TmatsG:PCMFormatAttributes>
```

Figure 5-47. “Look and Feel” P-Group Chapter 7 Example XML

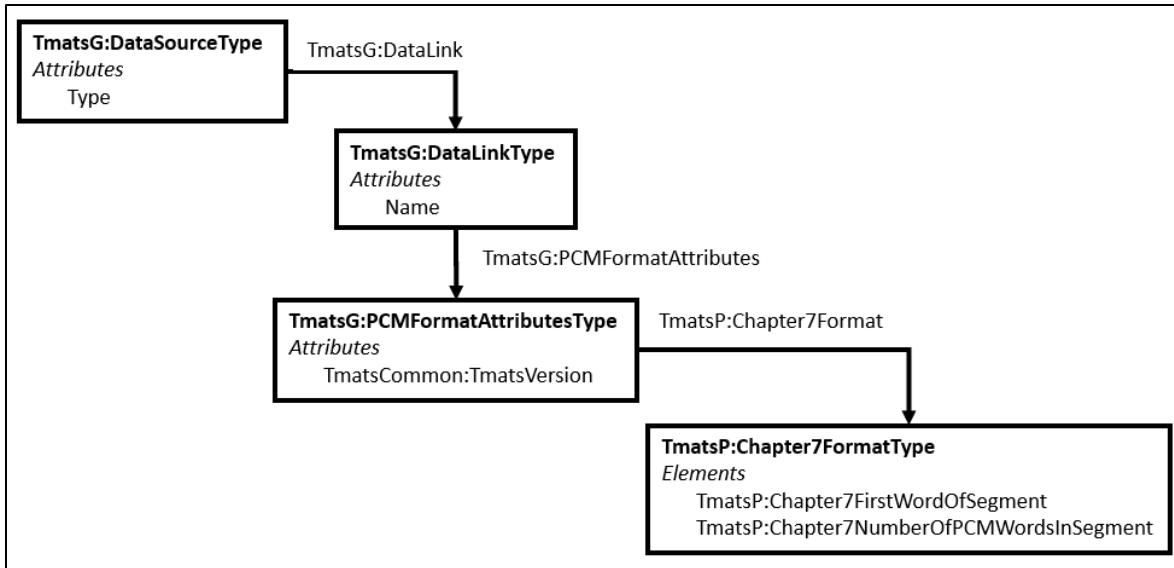

Figure 5-48. “Look and Feel” P-Group Chapter 7 XML Schema

Table 5-9. “Look and Feel” P-Group Chapter 7 XML Element-TMATS Code Name Pair	
XML Element Relative to TmatsP:PCMFormatAttributes/TmatsP:Chapter7Format	Code Name
N/A	[P-d\C7\N]
TmatsP:Chapter7FirstWordOfSegment	[P-d\C7FW-n]
TmatsP:Chapter7NumberOfPCMWordsInSegment	[P-d\C7NW-n]

5.6.2 Example 2

The following example describes a PCM frame, where the Chapter 7 Packet Telemetry Data Frame is inserted into the PCM data in 4 sections.

	W1	W2	W3	W4	...	W46	W47	W48	W49	W50	W51	...	W90	W91
FS	PCM Data			Packet Telemetry Data			PCM Data			Packet Telemetry Data				
	W92	W93	W94	W95	...	W194	W195	W196	W197	W198	W199	...	W254	W255
	PCM Data			Packet Telemetry Data			PCM Data			Packet Telemetry Data				

The following attributes will describe this Chapter 7 stream:

- P-1\C7\N:4;**
- P-1\C7FW-1:4;**
- P-1\C7NW-1:43;**
- P-1\C7FW-2:50;**
- P-1\C7NW-2:42;**
- P-1\C7FW-3:95;**
- P-1\C7NW-3:100;**
- P-1\C7FW-4:198;**
- P-1\C7NW-4:58;**

The number of bytes in the Chapter 7 Packet Telemetry Data Frame depends on the number of bits in the PCM Data Words. Assuming all PCM data words have the same length, the total Chapter 7 Packet Telemetry Data Frame length can be calculated as in [Table 5-10](#) below.

<b>Table 5-10. Calculating Chapter 7 Packet Telemetry Data Frame Length</b>			
Data Word Length in bits	Calculation	Ch7 Frame length in bytes	Comment
8	$43*8/8+42*8/8+100*8/8+58*8/8$	243	no fill bits
10	$43*10/8+42*10/8+100*10/8+58*10/8$ $= 53 + 52 + 125 + 72$	302	6, 4, 0, and 4 bits are fill Bits at the end of the Sections 1,2,3, and 4
16	$43*16/8+42*16/8+100*16/8+58*16/8$	486	no fill bits

### 5.7 Data Source ID and Data Link Name Clarifications

Interoperability issues between recorders have arisen between Data Source ID (the TMATS code word DSI) and Data Link Name (the TMATS code word DLN).

One is a hierarchy issue and the second issue is how each recorder determines a source for playing back recorded data. With respect to the hierarchy issue, figure 9-1 of Chapter 9 shows the DSI at the input of the recorder. Data using different paths is presented to the recorder with DSI.

The diagram in [Figure 5-49](#) and the TMATS sample code below contain example usages of Data Source ID and Data Link Name. The R-x\CDLN-n and P-d\DLN snippets describe the format of the data or the type of stream that is being processed. It is recommended that the recording community agree to use DSI as the variable to select and play back a recorded channel.

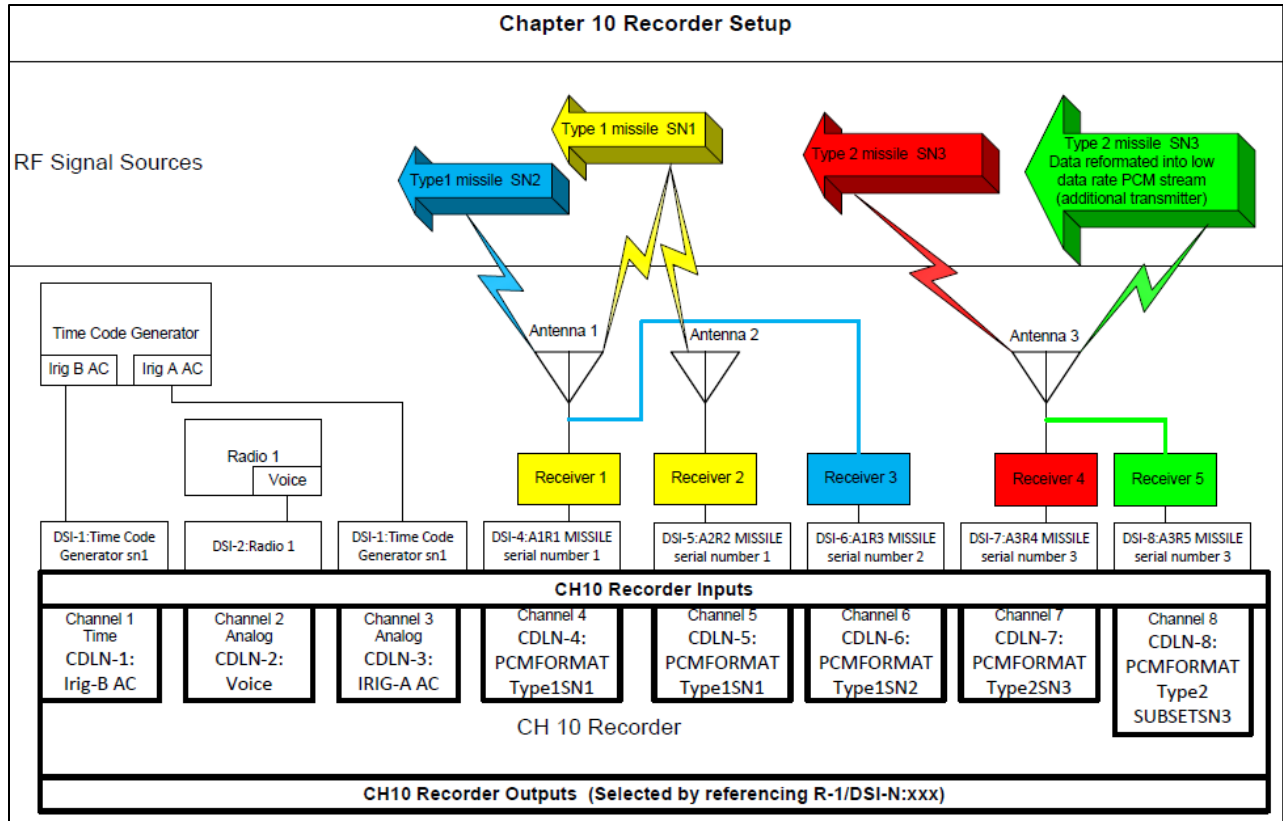

Figure 5-49. Data Source ID-Data Link Name Example

```
G\DSI\N:7;
G\DSI-1:CH10 Recorder;
G\DSI-2:Time Code Generator sn1;
G\DSI-3:A1R1 MISSILE serial number 1;
G\DSI-4:A2R2 MISSILE serial number 1;
G\DSI-5:A1R3 MISSILE serial number 2;
G\DSI-6:A3R4 MISSILE serial number 3;
G\DSI-7:A3R5 MISSILE serial number 3;
```

```
COMMENT:The Recorder;
R-1\ID:CH10 Recorder;
```

```
COMMENT:TIME CHANNEL 1;
R-1\DSI-1:Time Code Generator sn1;
R-1\CDLN-1:Irig-B AC;
```

```
COMMENT: Channel 2 - Analog ;
R-1\DSI-2:Radio 1;
R-1\CDLN-2:Voice;
R-1\AMN-2-1:Voice;
```



COMMENT: Channel 3 - Analog ;  
R-1\DSI-3:Time Code Generator sn1;  
R-1\CDLN-3:IRIG-A AC;  
R-1\AMN-3-1:IRIG-A AC;

COMMENT: CHANNEL 4 - PCM;  
R-1\DSI-4:A1R1 MISSILE serial number 1;  
R-1\CDLN-4:PCMFORMATTYPE1SN1;  
P-1\DLN: PCMFORMATTYPE1SN1;

COMMENT: CHANNEL 5 - PCM (same missile as channel 4, but different antenna and receiver);

R-1\DSI-5:A2R2 MISSILE serial number 1;  
R-1\CDLN-5: PCMFORMATTYPE1SN1;  
COMMENT: Use P-1\DLN: PCMFORMATTYPE1SN1 defined above;

COMMENT: CHANNEL 6 - PCM;  
R-1\DSI-6:A1R3 MISSILE serial number 2;  
R-1\CDLN-6: PCMFORMATTYPE1SN2;  
P-2\DLN: PCMFORMATTYPE1SN2;

COMMENT: CHANNEL 7 - PCM;  
R-1\DSI-7:A3R4 MISSILE serial number 3;  
R-1\CDLN-7: PCMFORMATTYPE2SN3;  
P-3\DLN: PCMFORMATTYPE2SN3;

COMMENT: CHANNEL 8 - PCM;  
R-1\DSI-8:A3R5 MISSILE serial number 3;  
R-1\CDLN-8: PCMFORMATTYPE2 SUBSETS3;  
P-4\DLN: PCMFORMATTYPE2 SUBSETS3;

This page intentionally left blank.

## CHAPTER 6

### Adding a Simple Embedded Stream to the Simple Example

Now that you have the basics for structuring a TMATS file, let's expand some and add a simple embedded stream to the simple example used in [Chapter 2](#) and [Chapter 3](#). In [Figure 6-1](#) you will see the parent stream with an embedded stream in frame location 1 and word location 3. The embedded stream in this example only contains one frame.

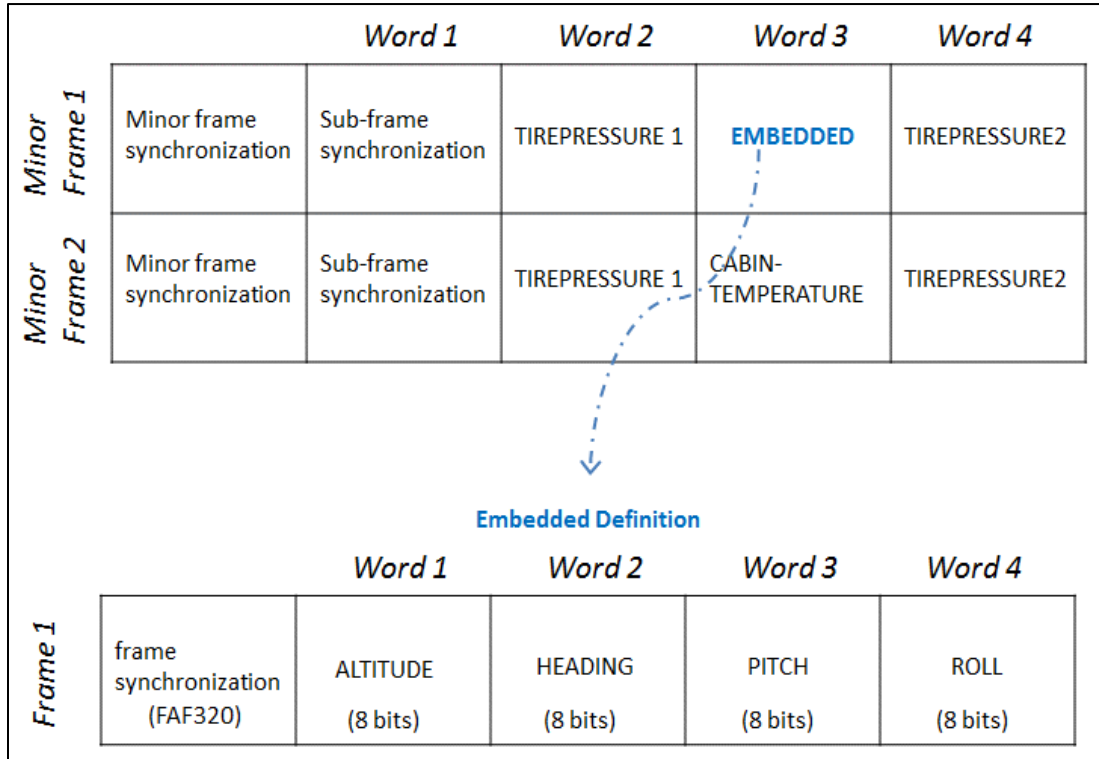

Figure 6-1. Simple Embedded PCM Example

Other attributes:

Bit Rate.	1 Mbps
Frame Sync Pattern.	FAF320
Common Word Length.	8 bits
All measurements.	2's complement
All measurements.	→ Gain = .0025    Offset = -5.12

For a simple TMATS file, we will describe the embedded PCM data from the diagram example.

```
COMMENT:Embedded Location in Host Format;
P-1\AEF\N:1;                               Indicates there is only one embedded format
P-1\AEF\DLN-1:EMBEDDED_STREAM;           This ties to P-2 defined here
P-1\AEF1-1:NO;                             Not supercom
P-1\AEF2-1:EL;                             List every location
```

P-1\AEF3-1-1:3;	Only in word 3
P-1\AEF5-1-1:16;	All 16 bits in this word are embedded
P-1\AEF7-1-1:1;	One subcom definition
P-1\AEF8-1-1-1:1;	Start in minor frame 1
P-1\AEF9-1-1-1:0;	No interval – only in minor frame 1
COMMENT:Embedded Format;	
P-2\DLN:EMBEDDED_STREAM;	Embedded data link name
P-2\D1:NRZ-L;	PCM code
P-2\D2:1000000;	Bit rate
P-2\TF:ONE;	Class 1
P-2\F1:8;	Common word length
P-2\F2:M;	MSB first
P-2\MF\N:1;	One minor frame per major frame
P-2\MF1:5;	Words per frame
P-2\MF3:FPT;	Fixed sync pattern
P-2\MF4:24;	Sync pattern length
COMMENT: Frame Sync Pattern of FAF320, defined in binary bits;	
P-2\MF5:111110101111001100100000	
P-2\ISF\N:0;	No ID counter
COMMENT:Embedded Format;	
D-2\DLN:EMBEDDED_STREAM;	Embedded data link name
D-2\ML\N:1;	Indicates one measurement list
D-2\MLN-1:Embedded List;	Measurement list name
D-2\MN\N-1:4;	Contains four measurements
D-2\MN-1-1:ALTITUDE;	
D-2\LT-1-1:WDFR;	
D-2\MML\N-1-1:1;	
D-2\MNF\N-1-1-1:1;	
D-2\WP-1-1-1-1:1;	Word 1
D-2\WI-1-1-1-1:0;	No interval
D-2\FP-1-1-1-1:1;	Frame 1
D-2\FI-1-1-1-1:1;	Every frame
D-2\WFM-1-1-1-1:FW;	Use all bits in word
D-2\MN-1-2:HEADING;	
D-2\LT-1-1:WDFR;	
D-2\MML\N-1-2:1;	
D-2\MNF\N-1-2-1:1;	
D-2\WP-1-2-1-1:2;	Word 2
D-2\WI-1-2-1-1:0;	No interval
D-2\FP-1-2-1-1:1;	Frame 1
D-2\FI-1-2-1-1:1;	Every frame
D-2\WFM-1-2-1-1:FW;	Use all bits in word
D-2\MN-1-3:PITCH;	
D-2\LT-1-1:WDFR;	

D-2\MML\N-1-31;  
 D-2\MNF\N-1-3-1:1;  
 D-2\WP-1-3-1-1:3; Word 3  
 D-2\WI-1-3-1-1:0; No interval  
 D-2\FP-1-3-1-1:1; Frame 1  
 D-2\FI-1-3-1-1:1; Every frame  
 D-2\WFM-1-3-1-1:FW; Use all bits in word  
**D-2\MN-1-4:ROLL;**  
 D-2\LT-1-1:WDFR;  
 D-2\MML\N-1-4:1;  
 D-2\MNF\N-1-4-1:1;  
 D-2\WP-1-4-1-1:4; Word 4  
 D-2\WI-1-4-1-1:0; No interval  
 D-2\FP-1-4-1-1:1; Frame 1  
 D-2\FI-1-4-1-1:1; Every frame  
 D-2\WFM-1-4-1-1:FW; Use all bits in word  
 COMMENT:Embedded Data Conversions;  
**C-5\DCN:ALTITUDE;**  
 C-5\MN1:Pressure Altitude;  
 C-5\BFM:TWO;  
 C-5\DCT:COE;  
 C-5\CO\N:1;  
 C-5\CO:-5.12;  
 C-5\CO-1:0.0025;  
**C-6\DCN:HEADING;**  
 C-6\MN1:True Heading;  
 C-6\BFM:TWO;  
 C-6\DCT:COE;  
 C-6\CO\N:1;  
 C-6\CO:-5.12;  
 C-6\CO-1:0.0025;  
**C-7\DCN:PITCH;**  
 C-7\MN1:Pitch;  
 C-7\BFM:TWO;  
 C-7\DCT:COE;  
 C-7\CO\N:1;  
 C-7\CO:-5.12;  
 C-7\CO-1:0.0025;  
**C-8\DCN:ROLL;**  
 C-8\MN1:Roll;  
 C-8\BFM:TWO;  
 C-8\DCT:COE;  
 C-8\CO\N:1;  
 C-8\CO:-5.12;  
 C-8\CO-1:0.0025;

This page intentionally left blank.

## Appendix A

### Extensible Markup Language TMATS Differences

The TMATS XML schema is identical in content to the original “code name” format of TMATS, with the exceptions shown below.

- a. The schema contains a C-Group for each data link, while code name TMATS has one C-Group in the entire TMATS file.
- b. The schema has no counter (“\N”) attributes; they are not needed in XML.
- c. Keyword attribute values are expanded for readability in the schema.
- d. Date and time formats are different; the schema uses the XML standard date and time formats, while code name TMATS has its own unique formats.
- e. Text entries in the XML schema may contain semicolons; the code name format cannot because it uses the semicolon as a delimiter.
- f. The inherent structure of an XML schema implies order, while the code name format allows the attributes to be given in any order.

*The link to the current TMATS XML schema can be found in RCC IRIG 106, Chapter 9, paragraph 9.4.3 (XML Format).*

This page intentionally left blank.



## Appendix B

### Stuff People Should Never Have Done (But You Need To Be Able To Interpret)

#### B.1 Example of how to use Word and Frame and Utilize Frame Interval

If measurements are subcommutated or supercommutated, then it is wise to utilize the word and/or frame interval approach instead of describing every location, which should only be done when measurements are unevenly spaced.

##### B.1.1 Example: Worst and Best Practices of Using WDFR

In this example, the measurement AKPS3AN is sampled every other frame and is 32 frames deep. The worst practice would be to describe every frame location independently ([Figure B-1](#)). The best practice would be to use frame number and interval to identify all of the frame locations ([Figure B-2](#)). The TMATS attributes for each approach are shown in [Table B-1](#).

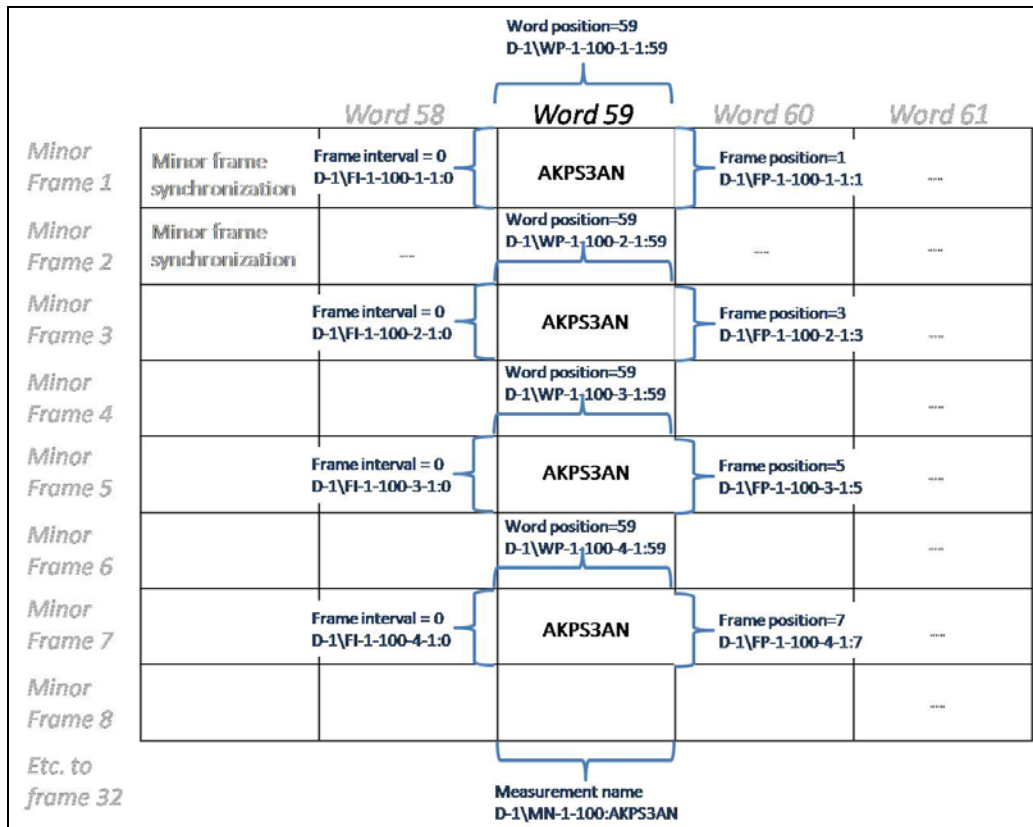

Figure B-1. Worst Practice: Describing Every Frame Location

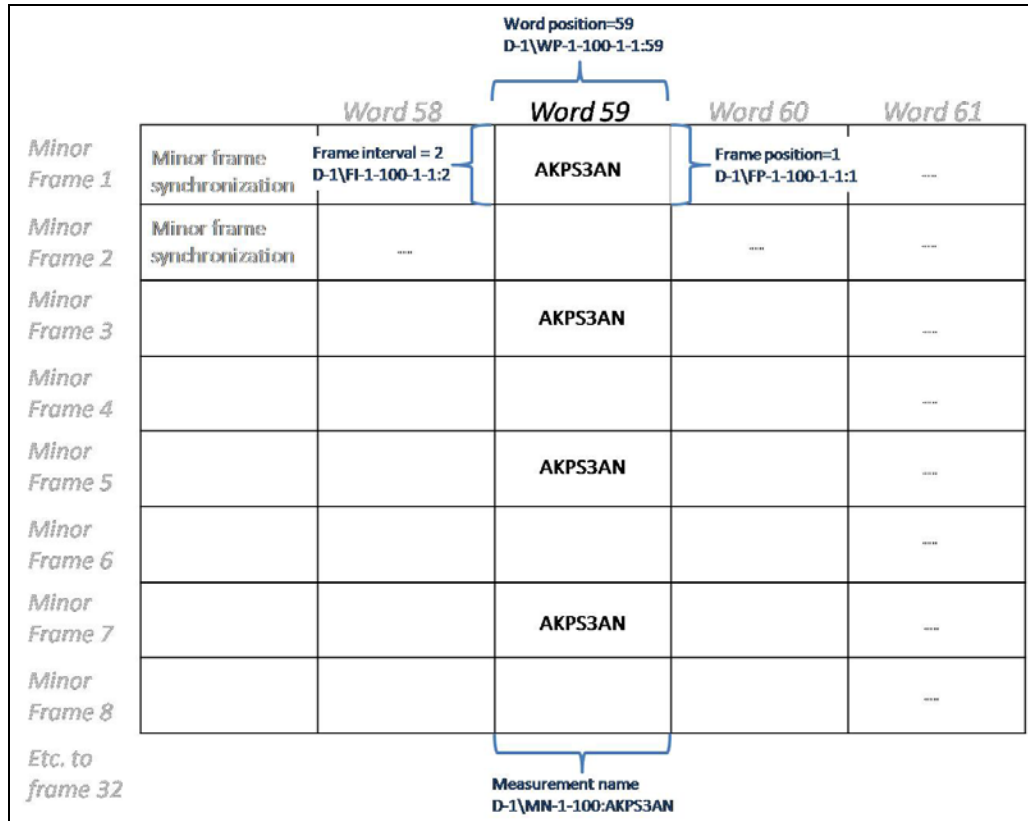

Figure B-2. Best Practice: Using Frame Number and Frame Interval to Identify All Frame Locations

Table B-1. Worst and Best Practices of Using Word and Frame	
Worst Practice	Best Practice
D-1\MN-1-100:AKPS3AN;	D-1\MN-1-100:AKPS3AN;
D-1\MN1-1-100:DE;	D-1\MN1-1-100:DE;
D-1\MN2-1-100:D;	D-1\MN2-1-100:D;
D-1\MN3-1-100:D;	D-1\MN3-1-100:D;
D-1\LT-1-100:WDFR;	D-1\LT-1-100:WDFR;
D-1\MML\N-1-100:16;	D-1\MML\N-1-100:16;
D-1\MNF\N-1-100-1:1;	D-1\MNF\N-1-100-1:1;
D-1\WP-1-100-1-1:59;	D-1\WP-1-100-1-1:59;
D-1\WI-1-100-1-1:0;	D-1\WI-1-100-1-1:0;
D-1\FP-1-100-1-1:1;	D-1\FP-1-100-1-1:1;
D-1\FI-1-100-1-1:0;	D-1\FI-1-100-1-1:2;
D-1\WFM-1-100-1-1: 000011111111111111;	D-1\WFM-1-100-1-1: 000011111111111111;
D-1\WFP-1-100-1-1:1;	
D-1\MNF\N-1-100-2:1;	
D-1\WP-1-100-2-1:59;	
D-1\WI-1-100-2-1:0;	
D-1\FP-1-100-2-1:3;	

<p>D-1\FI-1-100-2-1:0;  D-1\WFM-1-100-2-1:  0000111111111111;  D-1\WFP-1-100-2-1:1;  D-1\MNF\N-1-100-3:1;  D-1\WP-1-100-3-1:59;  D-1\WI-1-100-3-1:0;  D-1\FP-1-100-3-1:5;  D-1\FI-1-100-3-1:0;  D-1\WFM-1-100-3-1:  0000111111111111;  D-1\WFP-1-100-3-1:1;  D-1\MNF\N-1-100-4:1;  D-1\WP-1-100-4-1:59;  D-1\WI-1-100-4-1:0;  D-1\FP-1-100-4-1:7;  D-1\FI-1-100-4-1:0;  D-1\WFM-1-100-4-1:  0000111111111111;  D-1\WFP-1-100-4-1:1;  D-1\MNF\N-1-100-5:1;  D-1\WP-1-100-5-1:59;  D-1\WI-1-100-5-1:0;  D-1\FP-1-100-5-1:9;  D-1\FI-1-100-5-1:0;  D-1\WFM-1-100-5-1:  0000111111111111;  D-1\WFP-1-100-5-1:1;  D-1\MNF\N-1-100-6:1;  D-1\WP-1-100-6-1:59;  D-1\WI-1-100-6-1:0;  D-1\FP-1-100-6-1:11;  D-1\FI-1-100-6-1:0;  D-1\WFM-1-100-6-1:  0000111111111111;  D-1\WFP-1-100-6-1:1;  D-1\MNF\N-1-100-7:1;  D-1\WP-1-100-7-1:59;  D-1\WI-1-100-7-1:0;  D-1\FP-1-100-7-1:13;  D-1\FI-1-100-7-1:0;  D-1\WFM-1-100-7-1:  0000111111111111;  D-1\WFP-1-100-7-1:1;  D-1\MNF\N-1-100-8:1;  D-1\WP-1-100-8-1:59;</p>	
---	--

<p>D-1\WI-1-100-8-1:0;  D-1\FP-1-100-8-1:15;  D-1\FI-1-100-8-1:0;  D-1\WFM-1-100-8-1:  000011111111111111;  D-1\WFP-1-100-8-1:1;  D-1\MNF\N-1-100-9:1;  D-1\WP-1-100-9-1:59;  D-1\WI-1-100-9-1:0;  D-1\FP-1-100-9-1:17;  D-1\FI-1-100-9-1:0;  D-1\WFM-1-100-9-1:  000011111111111111;  D-1\WFP-1-100-9-1:1;  D-1\MNF\N-1-100-10:1;  D-1\WP-1-100-10-1:59;  D-1\WI-1-100-10-1:0;  D-1\FP-1-100-10-1:19;  D-1\FI-1-100-10-1:0;  D-1\WFM-1-100-10-1:  000011111111111111;  D-1\WFP-1-100-10-1:1;  D-1\MNF\N-1-100-11:1;  D-1\WP-1-100-11-1:59;  D-1\WI-1-100-11-1:0;  D-1\FP-1-100-11-1:21;  D-1\FI-1-100-11-1:0;  D-1\WFM-1-100-11-1:  000011111111111111;  D-1\WFP-1-100-11-1:1;  D-1\MNF\N-1-100-12:1;  D-1\WP-1-100-12-1:59;  D-1\WI-1-100-12-1:0;  D-1\FP-1-100-12-1:23;  D-1\FI-1-100-12-1:0;  D-1\WFM-1-100-12-1:  000011111111111111;  D-1\WFP-1-100-12-1:1;  D-1\MNF\N-1-100-13:1;  D-1\WP-1-100-13-1:59;  D-1\WI-1-100-13-1:0;  D-1\FP-1-100-13-1:25;  D-1\FI-1-100-13-1:0;  D-1\WFM-1-100-13-1:  000011111111111111;  D-1\WFP-1-100-13-1:1;</p>	
---	--

D-1\MNF\N-1-100-14:1; D-1\WP-1-100-14-1:59; D-1\WI-1-100-14-1:0; D-1\FP-1-100-14-1:27; D-1\FI-1-100-14-1:0; D-1\WFM-1-100-14-1: 0000111111111111; D-1\WFP-1-100-14-1:1; D-1\MNF\N-1-100-15:1; D-1\WP-1-100-15-1:59; D-1\WI-1-100-15-1:0; D-1\FP-1-100-15-1:29; D-1\FI-1-100-15-1:0; D-1\WFM-1-100-15-1: 0000111111111111; D-1\WFP-1-100-15-1:1; D-1\MNF\N-1-100-16:1; D-1\WP-1-100-16-1:59; D-1\WI-1-100-16-1:0; D-1\FP-1-100-16-1:31; D-1\FI-1-100-16-1:0; D-1\WFM-1-100-16-1: 0000111111111111;	
---	--

## B.2 Example of How Not to Combine Two Location Types

In this example, the worst practice combines the use of two location types: Subframes and word and frame.

As stated previously in this document and in RCC IRIG 106, Chapter 9, the best practice to describe the measurement location is to use word and frame and avoid using other location types in the same TMATS file. Use only word and frame.

Also, it is a best practice to avoid the use of subframes as defined in subframe definitions of the P-Group when using only word and frame.

Note: Prior to the RCC IRIG 106-11 version of the Telemetry Standards, there were several different measurement location types that could be used and were frequently combined with the word and frame location type. Starting in the 2011 release, the location types that were removed were as follows.

- a. MF        Minor Frame
- b. MFSC     Minor Frame Supercommutated
- c. MFFR     Minor Frame Fragmented
- d. SF        Subframe
- e. SFSC     Subframe Supercommutated

f. SFFR Subframe Fragmented

The following example ([Table B-2](#)Table B-2Table B-2) is only applicable if using attributes from the RCC IRIG 106-09 revision level or earlier.

Worst Practice	Best Practice
P-1\SF1-1-19:92; P-1\SF2-1-19:NO;	<i>Note: P-Group subframe definition should not be used when using WDFR</i>
D-1\MN-1-19:AMXD440_01; D-1\MN1-1-19:DE; D-1\MN2-1-19:D; D-1\MN3-1-19:M; D-1\LT-1-19:SF; D-1\SF1-1-19:92; D-1\SF2-1-19:5; D-1\SFM-1-19:FW;	D-1\MN-1-19:AMXD440_01; D-1\MN1-1-19:DE; D-1\MN2-1-19:D; D-1\MN3-1-19:M; D-1\LT-1-19:WDFR; D-1\MML\N-1-19:1; D-1\MNF\N-1-19-1:1; D-1\WP-1-19-1-1:92; D-1\WI-1-19-1-1:0; D-1\FP-1-19-1-1:5; D-1\FI-1-19-1-1:0; D-1\WFM-1-19-1-1:FW;
D-1\MN-1-51:AMXD440_CW; D-1\MN1-1-51:DE; D-1\MN2-1-51:D; D-1\MN3-1-51:M; D-1\LT-1-51:WDFR; D-1\MML\N-1-51:2; D-1\MNF\N-1-51-1:1; D-1\WP-1-51-1-1:86; D-1\WI-1-51-1-1:0; D-1\FP-1-51-1-1:5; D-1\FI-1-51-1-1:0; D-1\WFM-1-51-1-1:FW; D-1\WFP-1-51-1-1:1; D-1\MNF\N-1-51-2:1; D-1\WP-1-51-2-1:73; D-1\WI-1-51-2-1:0; D-1\FP-1-51-2-1:7; D-1\FI-1-51-2-1:0; D-1\WFM-1-51-2-1:FW;	D-1\MN-1-51:AMXD440_CW; D-1\MN1-1-51:DE; D-1\MN2-1-51:D; D-1\MN3-1-51:M; D-1\LT-1-51:WDFR; D-1\MML\N-1-51:2; D-1\MNF\N-1-51-1:1; D-1\WP-1-51-1-1:86; D-1\WI-1-51-1-1:0; D-1\FP-1-51-1-1:5; D-1\FI-1-51-1-1:0; D-1\WFM-1-51-1-1:FW; D-1\WFP-1-51-1-1:1; D-1\MNF\N-1-51-2:1; D-1\WP-1-51-2-1:73; D-1\WI-1-51-2-1:0; D-1\FP-1-51-2-1:7; D-1\FI-1-51-2-1:0; D-1\WFM-1-51-2-1:FW;

### B.3 Example of Best Practices for Measurement Names

Many TM front-end systems do not allow certain characters to be used in the measurement name. As stated previously, the best practices for measurement names are:

- a. Use capitalized alphabetic characters;
- b. Can use numeric characters;
- c. When using special characters in a measurement name, do not use spaces, dashes, or periods; only use an underscore "\_."

In the scenarios in [Table B-3](#), the worst practice demonstrates the use of lower-case alphabetic characters, spaces, hyphens, and a period in the measurement name. The best practice demonstrates the use of all capitalized alphabetic characters and underscores.

<b>Table B-3. Worst and Best Practices for Measurement Names</b>	
<b>Worst Practice</b>	<b>Best Practice</b>
D-1\MN-1-304:LAT STICK;	D-1\MN-1-304:LAT_STICK;
D-1\MN-1-62:AMXE600-09;	D-1\MN-1-62:AMXE600_09;
D-1\MN-1-144:STA1CAL.1;	D-1\MN-1-144:STA1CAL_1;
D-1\MN-1-350:mach;	D-1\MN-1-350:MACH;

### B.4 Example of a Worst Practice that Includes “Filler” Measurements

In this example, there may be locations within the major frame that do not have a measurement in a particular word and frame location. The worst practice includes all of the filler, or blanks, in the major frame.

If there are words within the major frame that are not occupied with measurement names and are considered to be filler measurements, the best practice is to not include the filler data in the TMATS file. There is no reason to add unnecessary content. [Table B-4](#) below is an example of this. Table B-4

<b>Table B-4. Worst and Best Practices for “Filler” Measurements</b>	
<b>Worst Practice</b>	<b>Best Practice</b>
D-1\MN-1-115:FILLER; D-1\MN1-1-115:DE; D-1\MN2-1-115:D; D-1\MN3-1-115:M; D-1\LT-1-115:WDFR; D-1\MML\N-1-115:231; D-1\MNF\N-1-115-1:1; D-1\WP-1-115-1-1:7; D-1\WI-1-115-1-1:0; D-1\FP-1-115-1-1:1; D-1\FI-1-115-1-1:0; D-1\WFM-1-115-1-1:FW;	Only include “true” measurements, not blanks (filler) in the major frame

<pre> D-1\WFP-1-115-1-1:1; D-1\MNF\N-1-115-2:1; D-1\WP-1-115-2-1:26; D-1\WI-1-115-2-1:0; D-1\FP-1-115-2-1:1; D-1\FI-1-115-2-1:0; D-1\WFM-1-115-2-1:FW; . . . D-1\WFM-1-115-230-1:FW; D-1\WFP-1-115-230-1:1; D-1\MNF\N-1-115-231:1; D-1\WP-1-115-231-1:258; D-1\WI-1-115-231-1:0; D-1\FP-1-115-231-1:16; D-1\FI-1-115-231-1:0; D-1\WFM-1-115-231-1:FW; D-1\WFP-1-115-231-1:1;                 </pre>	
---	--

## B.5 Using Counters

### B.5.1 List of Counter Attributes

When possible, the counter attributes (R-1\N, etc) should be listed before the list of items that they are counting. This makes it easier to read the file because you know you have X items before you start reading them. In this example, the R-1\N attribute tells us how many channels are present in the recording. Because R-1\N is 4, there are four channels in the recording. In the worst-case example, R-1\N is listed after the channels. The best case would be to put R-1\N first.

Another part of the worst practice example is that the attributes are not in a consistent order for each channel. Attributes should be output in the same order as they are described in the Chapter 9 standard so that the attributes for each channel will be in a consistent order. [Table B-5](#) below is an example of this.

<b>Table B-5. Worst and Best Practices for Listing Counter Attributes</b>	
<b>Worst Practice</b>	<b>Best Practice</b>
R-1\TK2-1:SSR;	R-1\N:4;
R-1\TK1-1:1;	...
R-1\DSI-1:1;	R-1\TK1-1:1;
R-1\TK4-1:1;	R-1\TK2-1:SSR;
R-1\TK3-1:FWD;	R-1\DSI-1:1;
R-1\CDT-1:TIMEIN;	R-1\TK3-1:FWD;
R-1\CHE-1:T;	R-1\TK4-1:1;
...	R-1\CHE-1:T;



R-1\DSI-2:1553CHANNEL;	R-1\CDT-1:TIMEIN;
R-1\CHE-2:T;	...
R-1\CDT-2:1553IN;	R-1\TK1-2:2;
R-1\TK3-2:FWD;	R-1\TK2-2:SSR;
R-1\TK1-2:2;	R-1\DSI-2:1553CHANNEL;
R-1\TK2-2:SSR;	R-1\TK3-2:FWD;
R-1\TK4-2:2;	R-1\TK4-2:2;
...	R-1\CHE-2:T;
R-1\CDT-3:PCMIN;	R-1\CDT-2:1553IN;
R-1\TK1-3:3;	...
R-1\DSI-3:PCMCHANNEL;	R-1\TK1-3:3;
R-1\TK2-3:SSR;	R-1\TK2-3:SSR;
R-1\TK3-3:FWD;	R-1\DSI-3:PCMCHANNEL;
R-1\TK4-3:3;	R-1\TK3-3:FWD;
R-1\CHE-3:T;	R-1\TK4-3:3;
...	R-1\CHE-3:T;
R-1\DSI-4:VIDEOCHANNEL;	R-1\CDT-3:PCMIN;
R-1\CDT-4:VIDIN;	...
R-1\TK3-4:FWD;	R-1\TK1-4:4;
R-1\TK4-4:4;	R-1\TK2-4:SSR;
R-1\TK1-4:4;	R-1\DSI-4:VIDEOCHANNEL;
R-1\TK2-4:SSR;	R-1\TK3-4:FWD;
R-1\CHE-4:T;	R-1\TK4-4:4;
...	R-1\CHE-4:T;
R-1\N:4;	R-1\CDT-4:VIDIN;

### B.5.2 Grouping of Attributes

Attributes should be grouped together by the measurements, channels, or other entities that they are describing, not by the attribute name. The best practice example shows that the attributes should be grouped by channel. The worst practice example shows the attributes grouped by attribute name. [Table B-6](#) is an example of this.

<b>Table B-6. Worst and Best Practices for Grouping Attributes</b>	
<b>Worst Practice</b>	<b>Best Practice</b>
R-1\N:4;	R-1\N:4;
...	...
R-1\CDT-1:TIMEIN;	R-1\TK1-1:1;
R-1\CDT-2:1553IN;	R-1\TK2-1:SSR;
R-1\CDT-3:PCMIN;	R-1\DSI-1:1;
R-1\CDT-4:VIDIN;	R-1\TK3-1:FWD;
...	R-1\TK4-1:1;
R-1\CHE-1:T;	R-1\CHE-1:T;
R-1\CHE-2:T;	R-1\CDT-1:TIMEIN;
R-1\CHE-3:T;	...
R-1\CHE-4:T;	R-1\TK1-2:2;
...	R-1\TK2-2:SSR;

R-1\DSI-1:1;	R-1\DSI-2:1553CHANNEL;
R-1\DSI-2:1553CHANNEL;	R-1\TK3-2:FWD;
R-1\DSI-3:PCMCHANNEL;	R-1\TK4-2:2;
R-1\DSI-4:VIDEOCHANNEL;	R-1\CHE-2:T;
...	R-1\CDT-2:1553IN;
R-1\TK1-1:1;	...
R-1\TK1-2:2;	R-1\TK1-3:3;
R-1\TK1-3:3;	R-1\TK2-3:SSR;
R-1\TK1-4:4;	R-1\DSI-3:PCMCHANNEL;
...	R-1\TK3-3:FWD;
R-1\TK2-1:SSR;	R-1\TK4-3:3;
R-1\TK2-2:SSR;	R-1\CHE-3:T;
R-1\TK2-3:SSR;	R-1\CDT-3:PCMIN;
R-1\TK2-4:SSR;	...
...	R-1\TK1-4:4;
R-1\TK3-1:FWD;	R-1\TK2-4:SSR;
R-1\TK3-2:FWD;	R-1\DSI-4:VIDEOCHANNEL;
R-1\TK3-3:FWD;	R-1\TK3-4:FWD;
R-1\TK3-4:FWD;	R-1\TK4-4:4;
...	R-1\CHE-4:T;
R-1\TK4-1:1;	R-1\CDT-4:VIDIN;
R-1\TK4-2:2;	
R-1\TK4-3:3;	
R-1\TK4-4:4;	

### B.5.3 Using Indices to Group Related Attributes

The TMATS uses indices to group related attributes together. It is a best practice to start all indices at 1 and count up. Indices should not be skipped. All indices from 1 to N should be used. Thus when counter attributes are used to describe the number of items that follow, you can easily see that the items will have indices from 1 to the counter value. In addition, the items should be listed in order by index. So all of the items with index 1 will precede all of the items with index 2. This is demonstrated in [Table B-7](#).

<b>Table B-7. Worst and Best Practices for Using Indices to Group Related Attributes</b>	
<b>Worst Practice</b>	<b>Best Practice</b>
R-1\N:3;	R-1\N:3;
...	...
R-1\TK1-5:1;	R-1\TK1-1:1;
R-1\TK2-5:SSR;	R-1\TK2-1:SSR;
R-1\DSI-5:1;	R-1\DSI-1:1;
R-1\TK3-5:FWD;	R-1\TK3-1:FWD;
R-1\TK4-5:1;	R-1\TK4-1:1;
R-1\CHE-5:T;	R-1\CHE-1:T;
R-1\CDT-5:TIMEIN;	R-1\CDT-1:TIMEIN;

...	...
R-1\TK1-2:2;	R-1\TK1-2:2;
R-1\TK2-2:SSR;	R-1\TK2-2:SSR;
R-1\DSI-2:1553CHANNEL;	R-1\DSI-2:1553CHANNEL;
R-1\TK3-2:FWD;	R-1\TK3-2:FWD;
R-1\TK4-2:2;	R-1\TK4-2:2;
R-1\CHE-2:T;	R-1\CHE-2:T;
R-1\CDT-2:1553IN;	R-1\CDT-2:1553IN;
...	...
R-1\TK1-4:3;	R-1\TK1-3:3;
R-1\TK2-4:SSR;	R-1\TK2-3:SSR;
R-1\DSI-4:PCMCHANNEL;	R-1\DSI-3:PCMCHANNEL;
R-1\TK3-4:FWD;	R-1\TK3-3:FWD;
R-1\TK4-4:3;	R-1\TK4-3:3;
R-1\CHE-4:T;	R-1\CHE-3:T;
R-1\CDT-4:PCMIN;	R-1\CDT-3:PCMIN;

This page intentionally left blank.

## Appendix C

### Glossary

**Alternate Tag and Data:** A PCM format that consists of frames containing tag words alternating in time sequence with data words.

**Attribute:** A parameter required to acquire, process, and display the TM data. Specified in TMATS as (Code Name:Data Item;).

**Big Endian:** The most significant byte is addressed first in memory.

**Binary Coded Decimal (BCD):** An encoding for decimal in which each digit is represented by its own binary sequence. In BCD, a digit is represented by four bits, in general, representing the decimal digits 0 through 9.

**Binary Numbers:** Representation of numbers in ones and zeros.

**Bi $\phi$ -L – Bi-Phase - Level:** PCM encoding.

**Bi $\phi$ -M –Bi-Phase - Mark:** PCM encoding.

**Bi $\phi$ -S – Bi-Phase - Space:** PCM encoding.

**Bit Mask:** Mechanism for selecting bits.

**Byte:** Eight bits.

**Check:** The state where a decommutator has found one synchronization pattern but needs to check to make sure the next (or more than 1) synchronization pattern is in the correct location.

**Class I:** Simple PCM characteristics that all ranges should be able to process.

**Class II:** More complex PCM characteristics that require concurrence from the range involved.

**Code Name:** The unique identifier of a TMATS attribute that precedes the colon character (:).

**Common Word Length:** Length of all words whose size has not been uniquely identified.

**Data Item:** The value of a TMATS attribute which follows the colon character (:).

**Data Link Name:** Uniquely identifies a data stream name.

**Data Link:** Uniquely identifies a data stream.

**Data Source:** Defines a source of a data stream.

**Derived Measurement:** A measurement that is not telemetered; rather, it is created from one or more telemetered measurements.

**Deviation:** Variance from a center frequency or the algebraic difference between a given value and its corresponding central reference value. This is used to specify the variance from a center frequency in a sub-carrier oscillator or a frequency modulated transmitter and is expressed in kHz or MHz. Either peak deviation or peak to peak deviation may be specified.

**Fragmented Measurement:** A measurement that is divided into no more than 8 segments or fragments which are placed in various locations within a minor frame that need not be adjacent.

**Frame Interval:** The number of frames between the first frame location and each subsequent frame location.

**Frame Position:** The frame location of a measurement location relative to the first minor frame of a major frame where the first minor frame is numbered one.

**Frequency Modulation (FM):** Method of conveying information over a carrier wave by varying its frequency (contrast this with amplitude modulation, in which the amplitude of the carrier is varied while its frequency remains constant). In analog applications, the difference between the instantaneous and the base frequency of the carrier is directly proportional to the instantaneous value of the input signal.

**Hexadecimal Numbers:** Refers to the base-16 number system, which consists of 16 unique symbols: the numbers 0 to 9 and the letters A to F.

**Keyword:** An enumeration of values for an attribute data item.

**Little Endian:** The least significant byte is addressed first in memory

**Lock:** When the synchronization pattern is in the correct location, the demodulator transitions to the final state which is "Lock." Once Frame lock is achieved, other data (such as sub frame synchronization) can be checked. The sub frame sync is used to identify the sub frame.

**Major Frame:** The number of minor frames required to include one sample of every measurement in the format.

**Mask:** A Mechanism of selecting bits of interest as ones and zeros.

**Measurand:** Used interchangeably with parameter and measurement.

**Measurement:** Used interchangeably with parameter and measurand.

**Minor Frame Synchronization Pattern:** A sequence of bits that defines the beginning of the minor frame.

**Minor Frame:** The data structure in a time sequence from the beginning of a minor frame synchronization pattern to the beginning of the next minor frame synchronization pattern.

**Modulation Index:** The modulation index ( $\beta$ ) is equal to the peak phase deviation when a single sinusoid angle modulates the rf carrier,  $\beta = \Delta\phi$ .

**Non Return to Zero - Level (NRZ-L):** PCM encoding.

**Non Return to Zero - Mark (NRZ-M):** PCM encoding.

**Non Return to Zero - Space (NRZ-S):** PCM encoding.

**Octave:** An octave is the interval between two points where the frequency at the second point is twice the frequency of the first.

**Offset Binary:** A digital coding scheme where all-zero corresponds to the minimal negative value and all-one to the maximal positive value. There is no standard for offset binary, but most often the “zero” value is represented by a 1 in the most significant bit and zero for all other bits.

**Parameter:** Used interchangeably with measurand and measurement.

**Parity:** Simplest form of error detecting code defined by the number of bits set to 1 in a word.

**Phase Modulation (PM):** A carrier modulation technique which changes the phase angle of the complex envelope in direct proportion to the message signal.

**Pre-Detection:** The portion of the receiver system that is used before detection (i.e., with signals that contain both carrier and all modulated signals). Diversity combiners use this signal to optimize the output from multiple receivers.

**Pulse Amplitude Modulation (PAM):** A baseband signal type, PAM has been primarily replaced with PCM.

**Pulse Code Modulation (PCM):** A serial bit stream of binary coded, time division multiplexed words.

**Randomized Non Return to Zero - Level (RNRZ-L):** PCM encoding.

**Search:** The state of a decommutator when it is looking for a synchronization pattern.

**Subcommutation:** A sampling of measurements at submultiple rates ( $1/D$ ) of the minor frame rate where the depth of a subframe,  $D$ , is an integer in the range of 2 to  $Z$  (where  $Z$  is the number of words in the deepest subframe).

**Subframe ID Counter:** A binary counter which counts sequentially up or down at the minor frame rate. The subframe ID counter shall be located in a fixed position in each and every minor frame. The counter should start with the minimum counter value when counting up or the maximum counter value when counting down. The counter should also be left or right justified in a word position. The start of a major frame shall coincide with the initial count for the deepest subframe.

**Subframe:** Defined as one cycle of the measurements from a subcommutated minor frame word position. The depth,  $D$ , of a subframe is the number of minor frames in one cycle before repetition.

**Supercommutation:** Defined as time-division-multiplex sampling at a rate that is a multiple of the minor frame rate. Supercommutation (on a minor frame) provides multiple samples of the same measurement in each minor frame. “Supercom on a subframe” is defined as time-division-multiplex sampling at a rate that is a multiple of the subframe rate and provides multiple samples of the same measurement within a subframe.

**Telemetered Data:** Data measured and transmitted from a remote location.

**Transmission Order:** The order in which bits of a word or measurement are placed in the transmission media.

**Unsigned Binary:** A numerical integer value that is always greater than or equal to zero.

**Word Interval:** The number of words between the first word location and each subsequent word location.

**Word Position:** The word number assigned to a PCM word location.



## Appendix D

### References

- Department of Defense. Aircraft Internal Time Division Command/Response Multiplex Data Bus. MIL-STD-1553B. 30 April 1975. May be superseded by update. Retrieved 8 June 2015. Available at [http://quicksearch.dla.mil/qsDocDetails.aspx?ident\\_number=36973](http://quicksearch.dla.mil/qsDocDetails.aspx?ident_number=36973).
- Range Commanders Council. *IRIG 106-07 Chapter 10 Programming Handbook*. RCC 123-09. March 2009. May be superseded by update. Retrieved 8 June 2015. Available at [http://www.wsmr.army.mil/RCCsite/Documents/123-09\\_IRIG\\_106-07\\_Chapter\\_10\\_Programming\\_Handbook/](http://www.wsmr.army.mil/RCCsite/Documents/123-09_IRIG_106-07_Chapter_10_Programming_Handbook/).
- . *Telemetry Applications Handbook*. RCC 119-06. May 2006. May be superseded by update. Retrieved 16 June 2015. Available at [http://www.wsmr.army.mil/RCCsite/Documents/119-06\\_Telemetry\\_Applications\\_Handbook/](http://www.wsmr.army.mil/RCCsite/Documents/119-06_Telemetry_Applications_Handbook/).
- . *Telemetry Standards*. Appendix D, Magnetic Tape Recorder and Reproducer Information and Use Criteria. IRIG 106-15. July 2015. May be superseded by update. Retrieved 1 July 2015. Available at [http://www.wsmr.army.mil/RCCsite/Documents/106-15\\_Telemetry\\_Standards/appendixD.pdf](http://www.wsmr.army.mil/RCCsite/Documents/106-15_Telemetry_Standards/appendixD.pdf).
- . “Application of the Telemetry Attributes Transfer Standard,” in *Telemetry Standards*. IRIG 106-15. July 2015. May be superseded by update. Retrieved 1 July 2015. Available at [http://www.wsmr.army.mil/RCCsite/Documents/106-15\\_Telemetry\\_Standards/appendixH.pdf](http://www.wsmr.army.mil/RCCsite/Documents/106-15_Telemetry_Standards/appendixH.pdf).
- . “Frequency Division Multiplexing Telemetry Standards,” in *Telemetry Standards*. IRIG 106-15. July 2015. May be superseded by update. Retrieved 1 July 2015. Available at [http://www.wsmr.army.mil/RCCsite/Documents/106-15\\_Telemetry\\_Standards/chapter3.pdf](http://www.wsmr.army.mil/RCCsite/Documents/106-15_Telemetry_Standards/chapter3.pdf).
- . “Pulse Code Modulation Standards,” in *Telemetry Standards*. IRIG 106-15. July 2015. May be superseded by update. Retrieved 1 July 2015. Available at [http://www.wsmr.army.mil/RCCsite/Documents/106-15\\_Telemetry\\_Standards/chapter4.pdf](http://www.wsmr.army.mil/RCCsite/Documents/106-15_Telemetry_Standards/chapter4.pdf).
- . “Digital Data Bus Acquisition Formatting Standard,” in *Telemetry Standards*. IRIG 106-15. July 2015. May be superseded by update. Retrieved 1 July 2015. Available at [http://www.wsmr.army.mil/RCCsite/Documents/106-15\\_Telemetry\\_Standards/chapter8.pdf](http://www.wsmr.army.mil/RCCsite/Documents/106-15_Telemetry_Standards/chapter8.pdf).
- . “Telemetry Attributes Transfer Standard,” in *Telemetry Standards*. IRIG 106-15. July 2015. May be superseded by update. Retrieved 1 July 2015. Available at

[http://www.wsmr.army.mil/RCCsite/Documents/106-15\\_Telemetry\\_Standards/Chapter9.pdf](http://www.wsmr.army.mil/RCCsite/Documents/106-15_Telemetry_Standards/Chapter9.pdf)

- . “Digital Recording Standard,” in *Telemetry Standards*. IRIG 106-15. July 2015. May be superseded by update. Retrieved 1 July 2015. Available at [http://www.wsmr.army.mil/RCCsite/Documents/106-15\\_Telemetry\\_Standards/chapter10.pdf](http://www.wsmr.army.mil/RCCsite/Documents/106-15_Telemetry_Standards/chapter10.pdf).
- . *Test Methods for Telemetry Systems and Subsystems, Volume 1. Test Methods for Vehicle Telemetry Systems*. RCC 118-12 Volume 1. May 2012. May be superseded by update. Retrieved 15 June 2015. Available at [http://www.wsmr.army.mil/RCCsite/Documents/118-12\\_Vol\\_1-Test\\_Methods\\_for\\_Vehicle\\_Telemetry\\_Systems/](http://www.wsmr.army.mil/RCCsite/Documents/118-12_Vol_1-Test_Methods_for_Vehicle_Telemetry_Systems/).
- . *XML Style Guide*. RCC 125-15. July 2015. Retrieved 13 January 2017. Available at [http://www.wsmr.army.mil/RCCsite/Documents/125-15\\_XML\\_Style\\_Guide/](http://www.wsmr.army.mil/RCCsite/Documents/125-15_XML_Style_Guide/).

**\*\*\*\*\* END OF TMATS HANDBOOK \*\*\*\*\***