

## CHAPTER 27

### RF Network Access Layer

<b>Acronyms</b> .....	<b>27-iii</b>
<b>Chapter 27. RF Network Access Layer</b> .....	<b>27-1</b>
<b>27.1 Introduction</b> .....	<b>27-1</b>
<b>27.2 Radio Access Network Concepts and Definitions</b> .....	<b>27-1</b>
27.2.1 Data Link Layer Framing.....	27-1
27.2.2 RF Media Access Control Layer.....	27-2
27.2.3 Epoch Structure.....	27-2
27.2.4 Transmission Opportunities .....	27-3
27.2.5 Timing.....	27-3
27.2.6 Radio Link State Parameters.....	27-3
27.2.7 Frame Check Sequence.....	27-3
<b>27.3 Physical Layer</b> .....	<b>27-3</b>
27.3.1 Data Rates and Spectrum .....	27-3
27.3.2 Regulatory Specifications, Spectral Mask .....	27-4
27.3.3 Carrier and Clock Frequency Error, Phase Noise, Spurs, Receiver Sensitivity 27-6	
<b>27.4 RF Burst Format</b> .....	<b>27-7</b>
27.4.1 Physical Layer Modulation .....	27-7
27.4.2 Preamble .....	27-8
27.4.3 Attached Synchronization Marker .....	27-8
27.4.4 Pseudo-Randomization .....	27-8
27.4.5 Low-Density Parity-Check .....	27-10
<b>27.5 RF Media Access Control Frame Structure</b> .....	<b>27-10</b>
27.5.1 RF MAC Header .....	27-11
27.5.2 CCMP Header.....	27-12
27.5.3 RF MAC Payload.....	27-13
27.5.4 Message Integrity Code .....	27-13
27.5.5 Frame Check Sequence Field.....	27-13
<b>27.6 Power Transients</b> .....	<b>27-13</b>
<b>Appendix 27-A. Air Data Rate Model</b> .....	<b>A-1</b>
<b>Appendix 27-B. Citations</b> .....	<b>B-1</b>

### List of Figures

Figure 27-1. OSI Model as related to the TmNS RF Network.....	27-1
Figure 27-2. Data Link Layer Framing Overview.....	27-2
Figure 27-3. Example Waveform PSD with Spectral Mask Overlay.....	27-5

Figure 27-4.	Single Sideband Phase Noise.....	27-6
Figure 27-5.	RF Burst Format .....	27-7
Figure 27-6.	SOQPSK-TG Burst Preamble.....	27-8
Figure 27-7.	Pseudo-Randomizer .....	27-9
Figure 27-8.	Pseudo-Randomization Block Diagram.....	27-9
Figure 27-9.	RF MAC Frame Structure.....	27-10
Figure 27-10.	RF MAC Header Structure .....	27-11
Figure 27-11.	Example TxOp Timing of a Single TxOp Allocation.....	27-14
Figure 27-12.	Example TxOp Timing of Two Back-to-Back TxOp Allocations.....	27-14

### List of Tables

Table 27-1.	Transceiver Phase Noise Mask .....	27-6
Table 27-2.	Maximum Doppler Shift.....	27-7

## Acronyms

μs	microsecond
ACK	acknowledgement
AES	Advanced Encryption Standard
ASM	attached synchronization marker
CBER	codeblock error rate
CCMP	Counter with Cipher Block Chaining Message Authentication Code mode Protocol
dBc	decibels relative to the carrier
FCS	frame check sequence
FPSH	fragmentation/packing sub-header
GHz	gigahertz
HAIPE	High Assurance Internet Protocol Encryptor
IP	Internet Protocol
kHz	kilohertz
LDPC	low-density parity-check
MAC	media access control
MHz	megahertz
MIC	Message Integrity Code
MSDU	MAC service data unit
OSI	Open Systems Interconnection
PLR	packet loss rate
ppm	parts per million
RC	Reliability Critical
RF	radio frequency
RFC	Request for Comment
SOQPSK	shaped offset quadrature phase shift keying
TA	test article
TCP	Transmission Control Protocol
TmNS	Telemetry Network Standard
TxOp	transmission opportunity

This page intentionally left blank.

## CHAPTER 27

### RF Network Access Layer

#### 27.1 Introduction

This chapter defines the mechanisms and processes for managing the physical layer of radio frequency (RF) links within the RF network. The network implements an Open Systems Interconnection (OSI) model approach ([Figure 27-1](#)) to data transmission, where data moves through the OSI stack from the application layer to the physical layer, from physical layer to physical layer through some transmission medium, then back up the stack to another application on the receiving side. Because the system is network-based, transmissions occur in bursts that are scheduled as data arrives.

OSI Model					
Layer	Data Unit	Function	Examples		
Host Layers	7. Application	Data	High Level APIs, including resource sharing, remote file access, directory services and virtual terminals	HTTP, FTP, SNMP, SSH, TELNET	
	6. Presentation		Translation of data between a networking service and an application, including character encoding, data compression and encryption/decryption	HTML, CSS, GIF	
	5. Session		Managing communications sessions, i.e. continuous exchange of information in the form of multiple back-and-forth transmissions between two nodes	RPC, PAP, SSL, SQL	
	4. Transport	Segments/Datagram	Managing communications sessions, i.e. continuous exchange of information in the form of multiple back-and-forth transmissions between two nodes	TCP, UDP, NETBEUI	
Media Layers	3. Network	Packet	Structuring and managing a multi-node network, including addressing, routing and traffic control	IPv4 IPv6, IPsec, Apple Talk, ICMP	
	2. Data Link	Frame	Reliable transmission of data frames between two nodes connected by a physical layer	PPP, IEE 802.2 L2TP, MAC, LLDP	IRIG 106 Chapter 28
	1. Physical	Bit	Transmission and reception of raw bit streams over a physical medium	Ethernet physical layer, DSL USB, ISDN, DOCSIS	Covered by this chapter

Figure 27-1. OSI Model as related to the TmNS RF Network

This chapter describes the low-level waveform content (e.g., Frequency, Modulation, Framing, etc.). [Chapter 28](#) focuses on access to and management of the RF portion of a Telemetry Network Standard (TmNS)-based network. [Chapter 21](#) Appendix 21-B describes the bit numbering, bit ordering, and byte ordering conventions used in this chapter.

#### 27.2 Radio Access Network Concepts and Definitions

##### 27.2.1 Data Link Layer Framing

The RF network provides a standards-based Internet Protocol (IP) network (Internet Engineering Task Force Request for Comment (RFC) 791<sup>1</sup> and RFC 2474<sup>2</sup>). Layers supporting this IP layer are unique to the RF network. [Figure 27-2](#) shows an overview of the protocol layers associated with sending an IP packet over the data link layer and RF physical interface. The IP

<sup>1</sup> Internet Engineering Task Force. "Internet Protocol." RFC 791. Updated by RFC 2474, RFC 6864, and RFC 1349. September 1981. Retrieved 7 July 2020. Available at <https://datatracker.ietf.org/doc/rfc791/>.

<sup>2</sup> Internet Engineering Task Force. "Definition of the Differentiated Services Field (DS Field) in the IPv4 and IPv6 Headers." RFC 2474. Updated by RFC 3260, RFC 3168, and RFC 8436. December 1998. Retrieved 7 July 2020. Available at <https://datatracker.ietf.org/doc/rfc2474/>.

packets are referred to as RF media access control (MAC) service data units (MSDUs) and are comprised of complete IP packets containing user data. The MSDUs are placed into payload blocks with aggregation and fragmentation performed to meet the maximum transmission unit of the RF channel. The length-limited payload blocks are separated into RF MAC frames and link layer header information is added. Forward error correction is added to the RF MAC frames to create low-density parity-check (LDPC) blocks suitable for transmission over the RF link. Details of the higher levels of this protocol are covered in [Chapter 28](#).

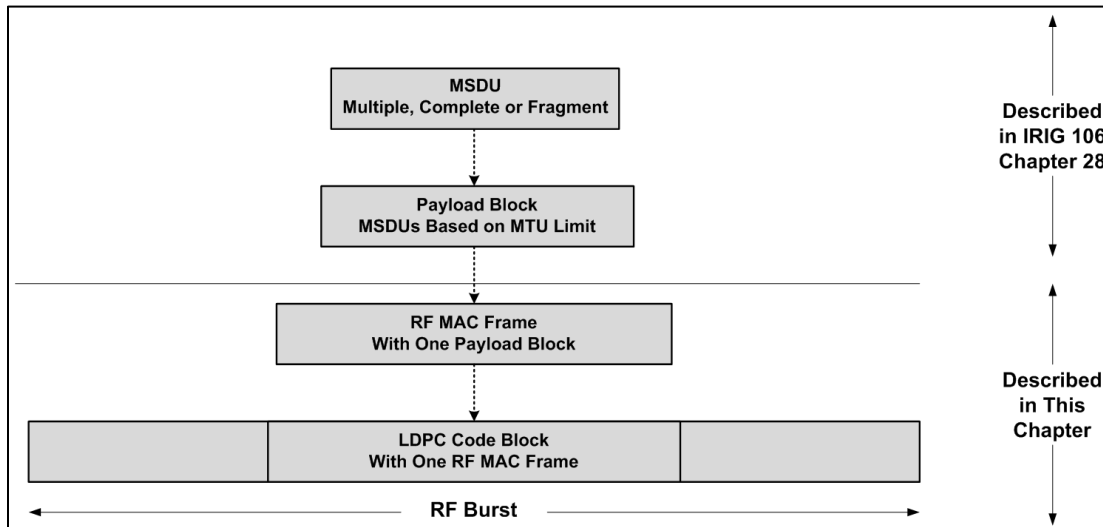

Figure 27-2. Data Link Layer Framing Overview

On the receiving end of the RF link, the physical layer recovers the transmitted bitstream by decoding and concatenating codeblocks arriving in the transmission opportunity's (TxOp's) time slots. Each decoded codeblock contains one MAC frame. These RF MAC frames contain complete IP packets or an IP packet composed of multiple MSDU fragments. [Chapter 28](#) describes MSDUs in more detail.

When a link layer frame is constructed for transmission in the process described here, the completed link layer frame sent shall not exceed the remaining portion of the current TxOp.

### 27.2.2 RF Media Access Control Layer

The RF MAC layer is responsible for providing access to the physical media (i.e., the wireless RF network). On the transmission side, it is responsible for framing IP packets for physical transmission (adding in the layer-2 hardware addresses for the source/destination pair of the link). On the receive side it is responsible for validating the checksum sent with each packet (known as the frame check sequence [FCS], Subsection [27.2.7](#)) and de-framing the received packet.

### 27.2.3 Epoch Structure

An epoch-based scheme is used to separate transmission signals over a time-shared medium. The RF network implements an epoch-based transmission scheduling scheme to provide an efficient utilization over a shared bandwidth. Link management messages support dynamic adjustment of the epoch schedule being utilized by components comprising an RF network.

#### 27.2.4 Transmission Opportunities

A TxOp is an allocated window in time during which a radio can transmit over its associated RF interface. The TxOp contains a frequency, a start time and a stop time that is relative to the epoch, and a timeout field that indicates the number of consecutive epochs that the TxOp is valid for. The frequency associated with the TxOp is the carrier frequency at which the transceiver shall transmit for the duration of the TxOp. At the stop time, the transceiver remains tuned to the TxOp's carrier frequency in order to receive incoming transmissions at the frequency. The epoch is settable to a number of discrete times during radio initialization.

#### 27.2.5 Timing

The RF link management and all radios under its control shall have their clocks synchronized. The timing of access to the RF media shall be synchronized to and match the timing with the management layer described in [Chapter 22](#). The format of the time in RF network messages is defined in [Chapter 24](#).

#### 27.2.6 Radio Link State Parameters

Operating parameters of a radio shall be stored to maintain communications with RF link management after a power interruption or software-initiated reset. Parameters to be stored include, as a minimum, the operating frequency of the radio, the TxOp allocations that contain a non-expiring timeout setting, and the heartbeat value.

#### 27.2.7 Frame Check Sequence

The FCS contained at the end of an RF MAC frame shall serve as a link layer error-checking mechanism. The FCS generation and verification is described in Subsection [27.5.5](#).

### 27.3 **Physical Layer**

The physical layer focuses on describing the operating bands, waveform modulation/demodulation characteristics, carrier stability and synchronization/acquisition characteristics, and coding/decoding techniques. The TmNS system provides the capability of the range to support multiple concurrent test missions on one or more integrated Network Enhanced Telemetry frequency channels. The frequency channels available for use in a TmNS-based RF network are as defined in Subsection [27.3.1.2](#). Allowable adjacent channel interference for transmissions is defined in Subsection [27.3.2](#). Each transmission is performed as discrete bursts within start and stop times that are provisioned within a configured epoch time by an external configuration file and/or RF link management as defined in [Chapter 28](#).

Transmissions between radios on test articles (TAs) and those contained in the ground network shall use the same carrier frequency in both directions. Single carrier frequency usage is supported by employing a time-domain duplex channel access method. In this method radios use re-occurring epoch-based transmissions defined by start and stop times that are provisioned by RF link management.

#### 27.3.1 Data Rates and Spectrum

##### 27.3.1.1 Radio Air Data Rates

The data rates and link performance in terms of packet loss rate (PLR) stated below are provided based on 1000-byte-long Ethernet packet (see [Appendix 27-A](#) for additional details).

Assuming the codeblock error events to be independent, the relation between codeblock error rate (CBER) and PLR is then given by  $CBER = 1 - \sqrt{1 - PLR}$ . For example, for a PLR of  $1 \times 10^{-4}$ , the corresponding CBER is  $5 \times 10^{-5}$ .

Subsection [27.3.2.2.2](#) details the air data rates that radios shall comply with in order to ensure interoperability.

Rate requirements can be viewed from various aspects. When viewed from an OSI 7-layer protocol stack perspective, the RF communications link is at layer-2. This implies that all overhead affiliated with layer-3 through layer-7, including any IP and High Assurance Internet Protocol Encryptor (HAIPE) headers, are regarded as user data. The effective PLR is referenced to a mean packet size and is described in [Appendix 27-A](#).

 <p><b>NOTE</b></p>	<p>The air data rates are derived from a model that assumes a certain IP packet distribution such that the airborne network and throughput goals are met. Details concerning how to get from IP data payload rate to the air data rate are in <a href="#">Appendix 27-A</a>.</p>
--	--

### 27.3.1.2 Band of Operation

It is recommended that RF telemetry networks of the type described in this standard utilize the following frequencies: 4900.0 MHz and 4922.0 MHz. This facilitates interoperability and simultaneous operation of serial streaming telemetry and networked telemetry within airborne and ground systems. These channels have been coordinated through the Frequency Management Group of the Range Commanders Council. Range users should consult with their respective spectrum managers regarding the use of these channels at their ranges prior to designing, building, or fielding telemetry networks.

### 27.3.2 Regulatory Specifications, Spectral Mask

#### 27.3.2.1 SOQPSK-TG Single-Carrier Waveform – Spectral Mask

The RF emission spectral mask defined in [Chapter 2](#) shall be adopted for the single-carrier waveform for shaped offset quadrature phase shift keying (SOQPSK)-TG. Peak waveform power density for the SOQPSK-TG waveform is estimated to be  $-25$  decibels relative to the carrier (dBc)/30 kHz using the equation in [Chapter 2](#) Appendix 2-A with  $R_b = 20$  Mbps,  $K = -61$ , and  $m = 4$ .

$$M(f) = -61 + 90 \log R - 100 \log |f - f_c|; |f - f_c| \geq 5$$

 <p><b>NOTE</b></p>	<p><a href="#">Figure 27-3</a> shows a simulated SOQPSK-TG waveform and overlay with single-carrier spectral mask. The power spectra was calculated for 20-Mbps channel bit rate and compared with the continuous stream power spectra for a resolution bandwidth of 30 kHz. It was measured during the steady power condition during a burst transmission.</p>
--	---



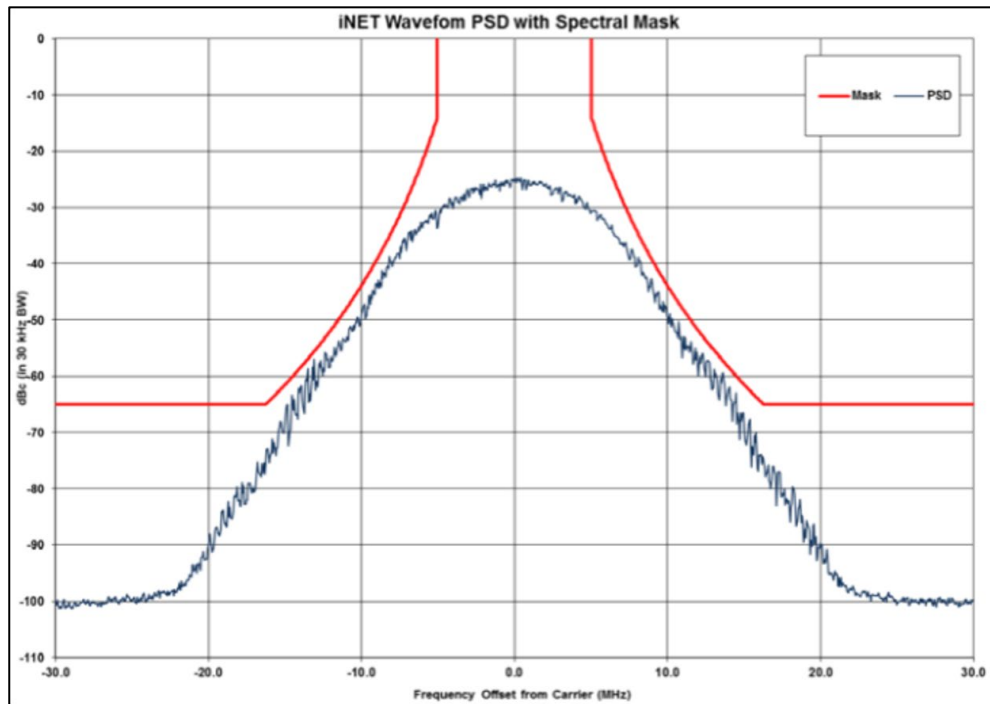

Figure 27-3. Example Waveform PSD with Spectral Mask Overlay

### 27.3.2.2 SOQPSK-TG Single-Carrier Waveform - Bandwidth

#### 27.3.2.2.1 Occupied Bandwidth

The SOQPSK-TG single-carrier waveform characteristics are defined in [Chapter 2](#). The waveform operating bands are defined in Subsection [27.3.1.2](#). The occupied bandwidth is defined to be the 99% power bandwidth, which for SOQPSK-TG is calculated to be 15.6 MHz for an air channel rate of 20 Mbps based on Table A-2, Appendix 2-A.

#### 27.3.2.2.2 Air Information Bit Rate

With the  $R_b$  fixed at 20 Mbps, the air information bit rate is 13.3 Mbps due to the 2/3 LDPC encoding.

#### 27.3.2.2.3 Guard-Bands and Band Edge Spurious Level

Spurious emissions are absolute limited to  $-25$  dBm. Guard-bands are identified via Adjacent Channel Interference criteria as defined in IRIG-106. See [Chapter 2](#) Appendix 2-A.

### 27.3.2.3 Multiple-Carrier Waveform - Spectral Mask

This section is a placeholder for future growth.

### 27.3.2.4 Multiple-Carrier Waveform - Bandwidth

This section is a placeholder for future growth.

27.3.3 Carrier and Clock Frequency Error, Phase Noise, Spurs, Receiver Sensitivity

27.3.3.1 SOQPSK-TG Single-Carrier Transmission

27.3.3.1.1 *Carrier Frequency Error*

The radio carrier frequency error shall be bounded by  $\pm 5$  parts per million (ppm). This corresponds to a frequency shift of  $\pm 25$  kHz at a transmission frequency of 5 gigahertz (GHz).

27.3.3.1.2 *Transceiver Phase Noise*

Random transceiver phase noise at the transceiver RF output port,  $L(|\Delta f|)$  in dBc/Hz, shall not exceed the mask limits in [Table 27-1](#). The parameter  $|\Delta f|$  is offset from the carrier frequency and  $R_b$  is the radio air channel bit rate in bits per second. The total power in discrete (deterministic) spurious noise components shall not exceed  $-30$  dBc in the same frequency offset range. Compliance with the mask shall be checked while the transceiver is producing an unmodulated continuous carrier signal at both the minimum and maximum power levels available for modulated burst transmission.

<b>Table 27-1. Transceiver Phase Noise Mask</b>	
<b>dBc/Hz</b>	<b>Frequency Offset</b>
$-30$ dBc/Hz	10 Hz
$-60$ dBc/Hz	100 Hz
$-70$ dBc/Hz	1 kHz
$-80$ dBc/Hz	10 kHz
$-90$ dBc/Hz	100 kHz
$-100$ dBc/Hz	1 MHz

The upper limit of the single sideband phase noise described by [Table 27-1](#) is depicted in [Figure 27-4](#).

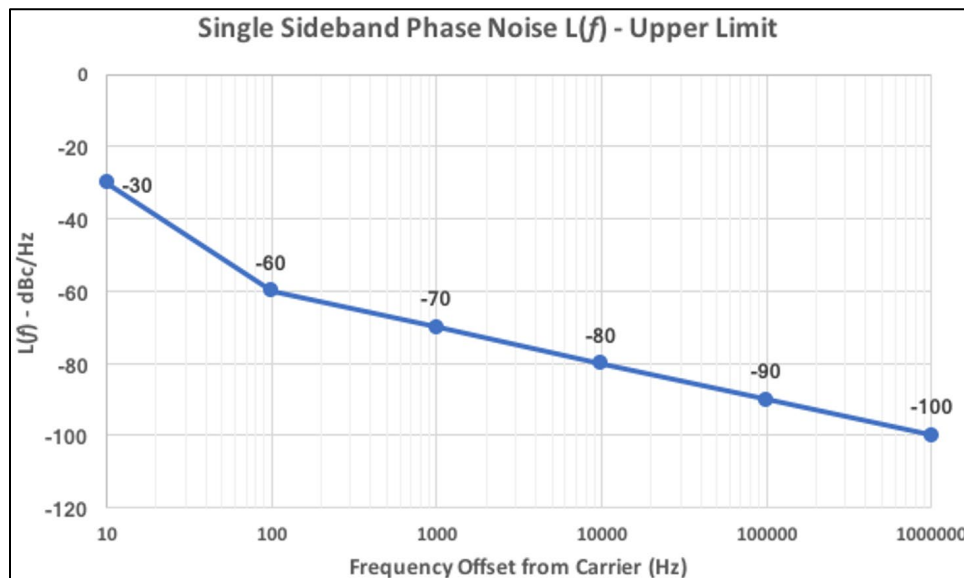

Figure 27-4. Single Sideband Phase Noise

27.3.3.1.3 *Frequency Error Attributed to Doppler*

The radio transmission frequency error seen at the receiver due to Doppler effects shall be bounded by  $\pm 2.5$  ppm. This corresponds to a frequency error spread of  $\pm 12.5$  kHz at a transmission frequency of 5 GHz. This frequency shift due to Doppler effects is budgeted for the combined total of relative motion between two transceivers, either between a stationary transceiver and a moving transceiver or between two moving transceivers. The maximum Doppler shift for a set of example carrier frequencies is provided in [Table 27-2](#) below.

<b>Table 27-2. Maximum Doppler Shift</b>	
<b>Carrier Frequency</b>	<b>Maximum Doppler Shift (<math>\pm 2.5</math> ppm)</b>
5 GHz	12.5 kHz
2.4 GHz	6 kHz
1.5 GHz	3.75 kHz

27.3.3.1.4 *Symbol Clock Frequency Error*

The radio transmission symbol clock frequency error shall be bounded by  $\pm 5$  ppm.

27.3.3.1.5 *Transmission Time Accuracy*

The radio transmission shall begin within  $\pm 1$   $\mu$ s of the intended transmission time.

27.3.3.2 Multiple-Carrier Transmission

This section is a placeholder for future growth.

 <p><b>NOTE</b></p>	Multiple-carrier waveform spectrum is subject to ongoing evaluation.
--	--

27.4 **RF Burst Format**

The RF burst format is displayed in [Figure 27-5](#).



Figure 27-5. RF Burst Format

The RF burst format contains a preamble, an attached synchronization marker (ASM), a codeblock frame, and 2 bits of trailing zeros to return the encoder to a flushed state. A codeblock frame may contain an integer multiple of LDPC codeblocks, from a minimum of 1 up to a maximum of 16. The number of LDPC codeblocks in a codeblock frame are specified during configuration.

27.4.1 Physical Layer Modulation

A single-carrier SOQPSK modulation scheme shall be used. The waveform shall be implemented as defined in [Chapter 2](#) Subsection 2.4.3.2.

27.4.2 Preamble

For the SOQPSK-TG waveform adopted for the single-carrier physical layer modulation format, the burst preamble is formed as described in [Figure 27-6](#). Starting from a flushed trellis (00 state), alternate the in-phase (I) and quadrature (Q) bits as follows.

$$\begin{array}{l}
 \text{In-phase: } b_{2k} = 1, 0, 1, 0, 1, 0, 1, 0 \\
 \text{Quadrature: } b_{2k+1} = 1, 0, 1, 1, 0, 1, 0, 0
 \end{array}
 \left. \vphantom{\begin{array}{l} \text{In-phase: } \\ \text{Quadrature: } \end{array}} \right\} \text{ for } k = 0, \dots, 7$$

repeated  $128/16 = 8$  times

Figure 27-6. SOQPSK-TG Burst Preamble

This leads to a period-16 ternary symbol sequence  $\{\alpha_k\}$  with the following structure.

$$\underbrace{(+1, +1, +1, +1, +1, +1, +1, 0)}_{7 \text{ +1s}}, \underbrace{(-1, -1, -1, -1, -1, -1, -1, 0, \dots)}_{7 \text{ -1s}}$$

For a 128-bit preamble, there shall be 8 full cycles of the period-16 preamble present in the transmitted SOQPSK-TG waveform.

27.4.3 Attached Synchronization Marker

For codeblock frame synchronization, a 64-bit ASM (64'h0347 76C7 2728 95B0) shall be used for each codeblock frame. This burst synchronizer can also be used for resolving phase ambiguity at the receiver.

27.4.4 Pseudo-Randomization

The pseudo-random sequence shall be generated using the following polynomial:  $h(x) = x^8 + x^7 + x^5 + x^3 + 1$ . It has a maximal length of 255 bits with the first 40 bits of the pseudo-random sequence from the generator as 40'b1111 1111 0100 1000 0000 1110 1100 0000 1001 1010. The sequence begins at the first bit of the first codeblock in a codeblock frame, and the sequence repeats after 255 bits, continuing repeatedly until the end of the last codeblock in a codeblock frame. The leftmost bit of the pseudo-random sequence is the first bit to be exclusive-ORed with the first bit of the codeblock. The pseudo-randomizer shown in [Figure 27-7](#) is described in more detail in [Chapter 2](#), Appendix 2-D.

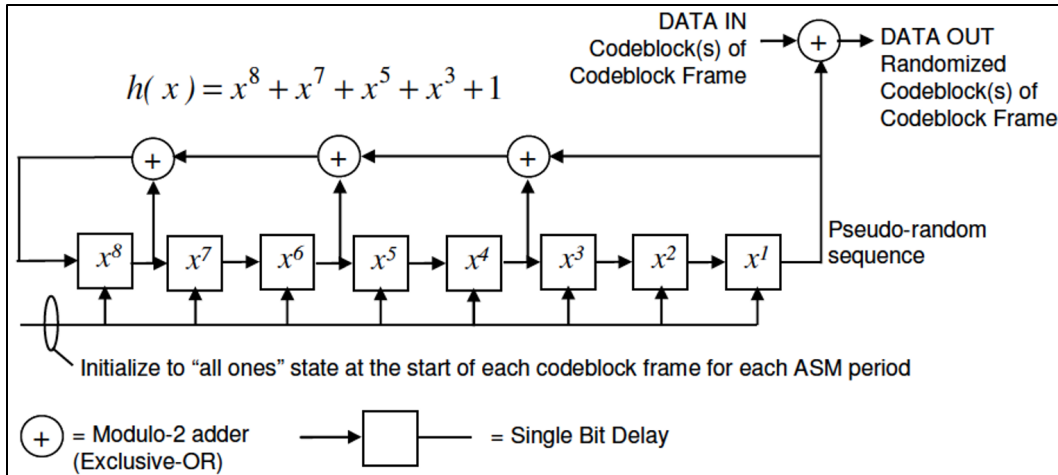

Figure 27-7. Pseudo-Randomizer

At the transmitter, a set of codeblocks in a codeblock frame shall be randomized by exclusive-ORing the first bit of the first codeblock with the first bit of the pseudo-random sequence, followed by the second bit of the first codeblock with the second bit of the pseudo-random sequence, and so on. The pseudo-randomizer resets to the initial state of "all ones" at the start of each codeblock frame for each ASM period.

At the receiver, each original codeblock of a codeblock frame shall be reconstructed using the same pseudo-random sequence. After locating the ASM, the pseudo-random sequence is exclusive-ORed with the received data bits immediately following the ASM. The pseudo-randomizer resets to the initial state of "all ones" at the start of each received codeblock frame for each ASM period.

The ASM, depicted in [Figure 27-8](#), is not randomized. Randomization ensures that coded symbols are spectrally near-white, thus allowing each ASM to provide synchronization for a set of randomized codeblock(s) in a codeblock frame.

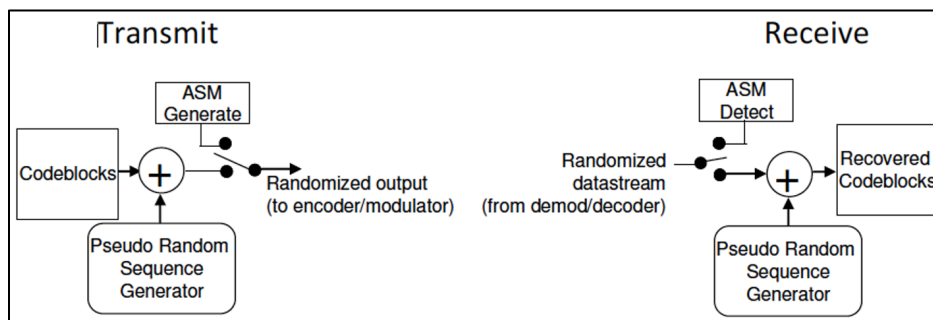

Figure 27-8. Pseudo-Randomization Block Diagram

At the transmitter side, the ASM is prepended to each set of randomized codeblocks as the synchronization header. At the receiver side, the ASM is detected and located in the received data stream. Then the pseudo-random sequence is exclusive-ORed with the data bits immediately following the ASM location.

### 27.4.5 Low-Density Parity-Check

Each LDPC codeblock shall contain one 512-byte RF MAC frame or, if the RF MAC frame is not 512 bytes, padding bytes with values of zero shall be added after the FCS to fill a 512-byte codeblock before encoding.

The Forward Error Correction code shall be an LDPC code as specified in CCSDS 131.1-O-2.<sup>3</sup>

A reference implementation of the LDPC is available from [Chapter 2](#) Appendix 2-D using the values  $r=2/3$  and  $k=4096$ .

## 27.5 RF Media Access Control Frame Structure

The MAC frame structure determines what RF transmissions are received by a receiving radio. The RF MAC filters received traffic, accepting only those transmissions that the radio is interested in receiving.

The network message headers for RF MAC control frames contain the destination, source, and a sequence number. The destination address is either an RF MAC address of the destination radio or an RF multicast address that specifies the multicast group of one or more receiving radios. The source address is always the RF MAC address of the transmitting radio. A sequence number is included to allow for duplicate rejection and identification of a specific link layer command.

Each RF MAC frame shall contain an RF MAC header, a CCMP header, an RF MAC payload, a Message Integrity Code (MIC) field, and a 32-bit FCS. The RF MAC frame format is depicted in [Figure 27-9](#).

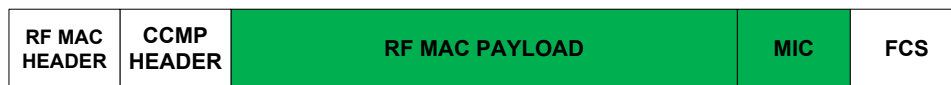

Figure 27-9. RF MAC Frame Structure

The RF MAC frame processing shall proceed with an equivalent of the following steps.

1. Codeblock is received, and the LDPC is decoded.
2. For successfully decoded LDPCs, the link layer processing checks the FCS.
3. The RF MAC frames with correct FCS fields are further inspected for the Destination Address field in the RF MAC header.
4. Further processing is carried out for RF MAC frames that contain a Destination Address for which the receiving radio has been assigned to listen.
  - a. If the Protected Frame bit indicates decryption is needed, the link layer processing then decrypts the frame and checks the MIC.
  - b. Unencrypted and successfully decrypted RF MAC payloads are processed as network data as described in [Chapter 28](#).

<sup>3</sup> Consultative Committee for Space Data Systems. *Low Density Parity Check Codes for Use in Near-Earth and Deep Space Applications*. Standard CCSDS 131.1-O-2-S. September 2007. Rescinded. Retrieved 7 July 2020. Available at <https://public.ccsds.org/Pubs/131x1o2e2s.pdf>.

Rejection at any of the steps described above does not require further processing, and the RF MAC frame shall be discarded; however, statistics for discarded RF MAC frames shall be maintained as described in [Chapter 25](#).

### 27.5.1 RF MAC Header

The RF MAC header is 64 bits long and shall consist of the fields as shown in [Figure 27-10](#).

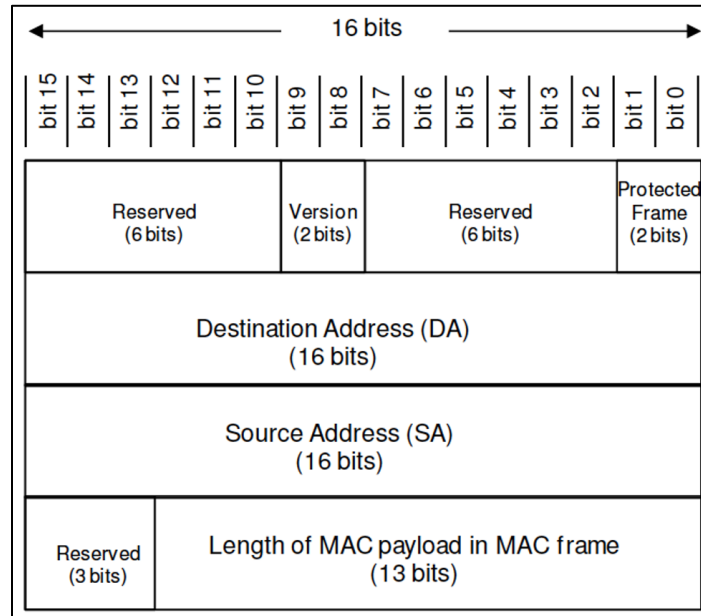



Figure 27-10. RF MAC Header Structure

**NOTE**  In the future, it may be desirable to have a MAC frame that spans 1-16 codeblocks. To provide for this future capability, the Length field in the MAC header is large enough to accommodate values up to 8192, i.e., [0 .. 8124] bytes (maximum of 16 codeblocks).

#### 27.5.1.1 Frame Control

The Frame Control field of the RF MAC header is 16 bits in length and shall contain the fields defined in Subsection [27.5.1.1.1](#) through Subsection [27.5.1.1.4](#).

##### 27.5.1.1.1 Reserved Field 1 (6 bits)

This field is reserved for future use. All bits shall be set to zero (6'b000000) on transmission; ignored on reception.

##### 27.5.1.1.2 Version Field (2 bits)

This field specifies the version of the RF MAC frame. This chapter defines the RF MAC Frame Version 1 (2'b00).

##### 27.5.1.1.3 Reserved Field 2 (6 bits)

This field is reserved for future use. All bits shall be set to zero (6'b000000) on transmission; ignored on reception.

#### 27.5.1.1.4 *Protected Frame Field (2 bits)*

This field indicates whether or not the RF MAC payload is encrypted. Transmitters shall set this field according to its configuration provided through a Metadata Description Language file. Receivers shall use this field to determine how to process the RF MAC payload.

This chapter defines the following versions:

- 2'b00 – Unprotected Frame
- 2'b01 – Advanced Encryption Standard (AES) - Counter with Cipher Block Chaining Message Authentication Code mode Protocol (CCMP)
- 2'b10 – Reserved for future use
- 2'b11 – Reserved for future use

#### 27.5.1.2 Destination Address

This 16-bit field contains the RF MAC address of the next hop destination radio or multicast RF MAC address. Additional details of RF MAC addressing are found in [Chapter 28](#).

#### 27.5.1.3 Source Address

This 16-bit field contains the RF MAC address of the transmitting radio. Additional details of RF MAC addressing are found in [Chapter 28](#).

#### 27.5.1.4 Reserved

This 3-bit field is reserved for future use. On transmission, the transmitting radio shall set this field to 3'b000. On reception, the receiving radio shall ignore these bits.

#### 27.5.1.5 Length

This 13-bit field contains the length in bytes of the RF MAC payload in the RF MAC frame. This value does not include the length of the RF MAC header or the associated FCS. The valid range for this field is [0 .. 500].

The Length field in the RF MAC header is used to separate valid bytes from padding bytes in the RF MAC frame. If there are valid bytes in the RF MAC payload, the first fragmentation/packing sub-header (FPSH) is checked for the priority and length of the subsequent MSDU\_block. The FPSH and its MSDU\_block are then passed for further processing. While valid bytes remain in the RF MAC payload, the next FPSH is checked and processing continues as above. Any padding bytes are discarded. Processing of bits within the RF MAC payload are described in detail in [Chapter 28](#).

#### 27.5.2 CCMP Header

AN 8-byte CCMP header shall follow immediately after the RF MAC header.



When AES encryption is employed, AES-CCMP encryption shall be used to generate the CCMP header, the encrypted payload, and the MIC. The CCMP header, encryption, and MIC shall follow the recommendations described in NIST SP 800-97.<sup>4</sup>

When AES encryption is not employed, the CCMP header field shall be set to zero (64'h0000 0000 0000 0000) for transmission; ignored on reception.

### 27.5.3 RF MAC Payload

The payload shall be encrypted or unencrypted according to the Protected Frame field of the RF MAC header. The length of the payload shall be in the range of 0-500 bytes.

If encryption is enabled, the AES-CCMP process shall generate the CCMP header.

### 27.5.4 Message Integrity Code

An 8-byte MIC is used. Details of the MIC are described in NIST SP 800-97.

When AES encryption is not employed, the MIC field shall be set to zero (64'h0000) for transmission; ignored on reception.

### 27.5.5 Frame Check Sequence Field

A 32-bit FCS shall be computed over the entire MAC frame, including the MAC header and the entire MAC payload (encrypted or unencrypted), using the IEEE 802.3<sup>5</sup> CRC-32 polynomial below:

$$x^{32} + x^{26} + x^{23} + x^{22} + x^{16} + x^{12} + x^{11} + x^{10} + x^8 + x^7 + x^5 + x^4 + x^2 + x + 1.$$

## 27.6 **Power Transients**

For RF power transients within a TxOp allocation, a radio shall become capable of full-power transmission 25 microseconds ( $\mu$ s) after the radio finishes receiving a transmission intended for it. Once a radio has ceased transmitting, the radio shall disable its transmission and be ready within 15  $\mu$ s to receive a transmission from another radio using default modulation modes and burst rates. A radio shall be capable of receiving consecutive symbol-synchronous burst sequences with no time separation between burst sequences. [Figure 27-11](#) provides an example TxOp timing allocation diagram that highlights the allowable transition times for the transceiver to transition between receiving and transmitting and vice versa. Any ramp-up or ramp-down times associated with a radio shall occur during the TxOp allocation of the radio. When a radio is not executing a TxOp, it shall be listening for RF transmissions from other radios.

---

<sup>4</sup> National Institute of Standards and Technology. "Establishing Wireless Robust Security Networks: A Guide to IEEE 802.11i." SP 800-97. May be superseded by update. Retrieved 7 July 2020. Available at <http://nvlpubs.nist.gov/nistpubs/Legacy/SP/nistspecialpublication800-97.pdf>.

<sup>5</sup> Institute of Electrical and Electronics Engineers. *IEEE standard for Ethernet*. IEEE Std 802.3-2012. New York: Institute of Electrical and Electronics Engineers, 2012.

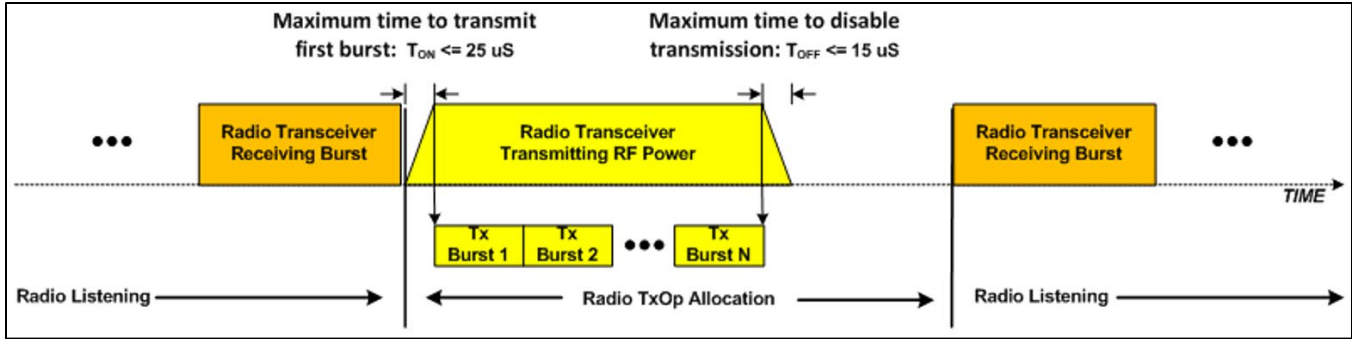

Figure 27-11. Example TxOp Timing of a Single TxOp Allocation

In the example provided in [Figure 27-11](#), the transmitting radio turned off its transmitter prior to the end of its TxOp allocation. If no additional data is available to send, a radio shall stop transmitting RF power.

[Figure 27-12](#) provides an example of another example TxOp timing allocation. This particular example shows two back-to-back TxOp allocations for the same source radio. A radio is not required to shut down its power amplifier if its next allocated TxOp immediately follows the current one.

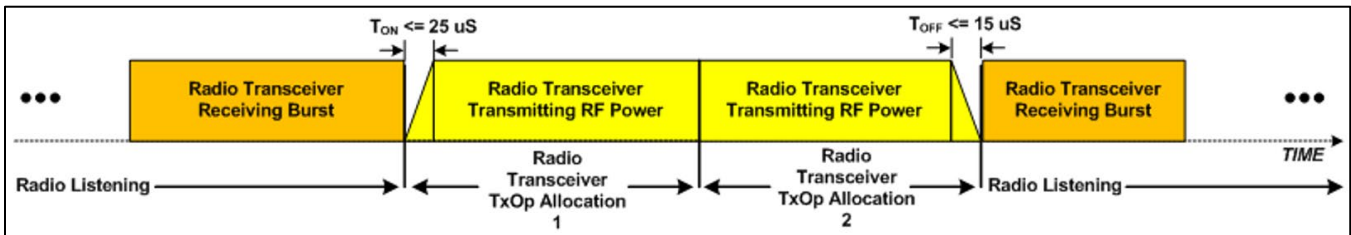

Figure 27-12. Example TxOp Timing of Two Back-to-Back TxOp Allocations

## APPENDIX 27-A

### Air Data Rate Model

Calculations leading to the standardized air data rate for the RF network are based on three spreadsheets. These spreadsheets move from an expected distribution of data use at the application level of the OSI model down through the details of each of the layers leading to the physical layer. Descriptions of the spreadsheets are provided below. While the path concerning the choices made is not directly part of this chapter, the spreadsheets are retained due to their usefulness in explaining the overhead and transformations that occur at each layer of the overall stack.

The first spreadsheet contains parameters that can be used to calculate the link margin. The spreadsheet is contained [here](#).

The second spreadsheet contains equations and calculations pertaining to the RF network. This spreadsheet is contained [here](#). The spreadsheet contains two tabs. The first contains tunable channel parameters that are used to calculate bandwidth estimates. The second contains the required  $E_b/N_0$  calculations. Each worksheet is described below in more detail.

The CH Parameters and BW Estimates worksheet contains tunable knobs that can be modified in order to determine the impact across the rest of the RF network. The most prominent knobs are identified by dark green cells. These include the radio air channel bit rate ( $R_b$ ), the number of TAs in the RF network ( $N_{TAs}$ ), the minimum latency requirement per link, and the max link distance to be accounted for. Light-green cells are also knobs, but their use is expected to be limited. These may be set when initializing the table. This includes the guard band times to allocate across the system as well as an average frame length of network traffic. Gray cells represent constants that shall not be modified. They correspond to parameters such as the LDPC coding rate, LDPC codeblock size, LDPC preamble, ASM sizes, and the goal rate for mission data from the program. The light-pink boxes represent calculated values based on the tuning knobs.

The Req  $E_b/N_0$  Values worksheet contains error rate calculations for SOQPSK modulation schemes. These include bit error rates, frame error rates, packet error rates, and the energy per bit to noise power spectral density ratio ( $E_b/N_0$ ). It correlates the packet error rate to the bit error rate. This is related to the suggested receiver sensitivity in Subsection [27.3.3.1.3](#).

The final spreadsheet describes the data rate calculations for different data flows. This spreadsheet is contained [here](#). This spreadsheet contains three worksheets; each of which describes the achievable data transfer rate for a particular data flow based on the effective bit rate provided over the RF channel. Each worksheet contains the following two tuning knobs.

- **$R_{nt}$  network throughput (Mbps)** – This knob allows the user to specify the total bit rate of the channel for IP data. This data rate represents the maximum data rate available to IP packets, which includes data payload and all other overhead associated with the IP packets.
- **HAIZE Setting** – This knob specifies the block truncation setting configuration of an inline HAIZE device. This knob is used when computing the associated overhead of a particular data flow for cases with block truncation enabled.

When the  $R_{nt}$  network throughput (Mbps) knob is set to the expected IP data rate over the RF channel, the  $R_{md}$  mission data: Application Transfer Rate (Mbps) columns will indicate the theoretical maximum application data rate across the system for the types of data specified. This knob can also be tuned in order to set the  $R_{md}$  mission data: Application Transfer Rate (Mbps) to a particular value. Once the desired application data transfer rate is reached, the knob then indicates the IP network throughput rate that would be required in order to achieve the calculated application data transfer rate.

The three worksheets describe typical data payload and associated protocol overhead bytes for the different types of data. For each data flow in each worksheet, the overhead bytes vary depending on whether block truncation is enabled or not at the encryptor. Calculations are performed for both block truncation enabled and block truncation disabled. For each case, the percent overhead is calculated along with the data transfer rate. The transfer rate is a function of the ratio of data bytes to total bytes (data plus overhead) times the effective IP bit rate available.

A list of assumptions for each worksheet is provided. The data flows in the three worksheets are described below.

### **FTP – Reliability Critical – TCP**

Transmission Control Protocol (TCP)-based data flows, such as file transfer protocol (FTP) transfers and Reliability Critical data retrieval sessions, attempt to maximize payload sizes, which results in lowering the total overhead of the transport. The calculations performed in this worksheet assume the transfers are long transfers that do not experience any connection/disconnection events. It also assumes the typical system default (e.g., un-optimized) TCP parameters. Other assumptions include that for TCP-based data flows, the data packets fit the block truncation size, thus not requiring any additional padding bytes when block truncation is enabled versus when block truncation is disabled. It also assumes that only one acknowledgement (ACK) packet is returned for every 10 FTP data packets sent.

Overhead bytes include FTP overhead, TCP headers, IP headers, and all HAIPE overhead. Because TCP requires ACKs to be returned, these have also been included in the total overhead calculation.

### **Latency Throughput Critical Data**

User Datagram Protocol-based data flows, such as Latency Throughput Critical data delivery of TmNSDataMessages, come in a variety of sizes. These different sizes affect the percent overhead associated with each flow. If the data flows through a HAIPE device with FPL enabled, there can be a significant impact to the percent overhead and realizable application data transfer rate. Because of this, the worksheet provides several sizes of acquisition data in order to show the impacts to overhead percentage and application data transfer rates between FTP enabled and disabled for the different sizes of acquisition data payloads.

### **SM**

System Management messages assume a single Simple Network Management Protocol (SNMP) request receives a single SNMP response. The SNMP protocol data unit in the request is considered the data to be transferred in this exchange. The entire response message is considered overhead in the calculations.

## APPENDIX 27-B

### Citations

- Consultative Committee for Space Data Systems. *Low Density Parity Check Codes for Use in Near-Earth and Deep Space Applications*. Standard CCSDS 131.1-O-2-S. September 2007. Rescinded. Retrieved 7 July 2020. Available at <https://public.ccsds.org/Pubs/131x1o2e2s.pdf>.
- Institute of Electrical and Electronics Engineers. *IEEE standard for Ethernet*. IEEE Std 802.3-2012. New York: Institute of Electrical and Electronics Engineers, 2012.
- Internet Engineering Task Force. “Definition of the Differentiated Services Field (DS Field) in the IPv4 and IPv6 Headers.” RFC 2474. Updated by RFC 3260, RFC 3168, and RFC 8436. December 1998. Retrieved 7 July 2020. Available at <https://datatracker.ietf.org/doc/rfc2474/>.
- . “Internet Protocol.” RFC 791. Updated by RFC 2474, RFC 6864, and RFC 1349. September 1981. Retrieved 7 July 2020. Available at <https://datatracker.ietf.org/doc/rfc791/>.
- National Institute of Standards and Technology. “Establishing Wireless Robust Security Networks: A Guide to IEEE 802.11i.” SP 800-97. May be superseded by update. Retrieved 7 July 2020. Available at <http://nvlpubs.nist.gov/nistpubs/Legacy/SP/nistspecialpublication800-97.pdf>.

**\* \* \* END OF CHAPTER 27 \* \* \***